



Impairment: Nonfinancial assets

Handbook

US GAAP

August 2023

frv.kpmg.us



Contents

Foreword.....	1
About this publication	2
1. Executive summary.....	4
2. Scope of impairment models	10
3. The unit of account.....	24
4. When to test	66
5. Carrying amount	100
6. Qualitative assessment	129
7. Recoverability test: Long-lived assets.....	146
8. Fair value measurement.....	184
9. Recognition and allocation	235
10. Disclosures	266
11. Goodwill amortization accounting alternative.....	280
Appendices	
A. Goodwill impairment pre-ASU 2017-04	298
Index of changes	317
KPMG Financial Reporting View	318
Acknowledgments	320

Roadmap to impairment

Testing nonfinancial assets for impairment can be challenging – made more so by the need to navigate different impairment models: goodwill under Subtopic 350-20, indefinite-lived intangible assets under Subtopic 350-30, and long-lived assets under Topic 360.

Each impairment model has its own complexities in determining the unit of account, knowing when to test for impairment, and calculating the amount of any impairment loss. But while each model is independent, they are also inextricably linked – containing overlapping concepts and requiring a specific sequence in impairment testing.

This Handbook pulls together the three models to create a single roadmap to testing nonfinancial assets for impairment. We have organized the content to help you compare and contrast the different models.

We hope you find this Handbook useful in understanding the relationship between the impairment models, and ultimately that it helps you navigate the challenges of impairment testing.

Nick Burgmeier and Julie Santoro

Department of Professional Practice, KPMG LLP

About this publication

The purpose of this Handbook is to assist you in applying the following impairment models for nonfinancial assets:

- Subtopic 350-20, goodwill
- Subtopic 350-30, indefinite-lived intangible assets
- Topic 360, long-lived assets.

Organization of the text

Each chapter of this Handbook includes excerpts from the FASB’s Accounting Standards Codification® and overviews of the relevant requirements. Our in-depth guidance is explained through Q&As that reflect the questions we encounter in practice. We include examples to explain key concepts.

Our commentary is referenced to the Codification and to other literature, where applicable. The following are examples:

- 350-30-35-2 is paragraph 35-2 of ASC Subtopic 350-30.
- 2003 AICPA Conf is the 2003 AICPA National Conference on Current SEC Developments.
- AAG-GDW 3.09 is paragraph 9 of chapter 3 of the AICPA’s Accounting and Valuation Guide: Testing Goodwill for Impairment.
- ASU 2017-04.BC26 is paragraph 26 of the basis for conclusions to Accounting Standards Update 2017-04.

Scope

In testing goodwill for impairment, the main discussion in this Handbook assumes the following.

- ASU 2017-04, Simplifying the Test for Goodwill Impairment, has been adopted. For entities that have not yet adopted the ASU, see [Appendix A](#).
- The goodwill amortization accounting alternative available for private companies (i.e. entities that are not public business entities or employee benefit plans) and NFPs has not been elected. For entities that have elected this accounting alternative, see [chapter 11](#).

In testing long-lived assets for impairment, the main discussion in this Handbook assumes the assets are classified as held-and-used. For an in-depth discussion of the accounting model for assets (disposal groups) classified as held-for-sale, see KPMG Handbook, [Discontinued operations and held-for-sale disposal groups](#).

Pending content

Topic 842 (leases)

This Handbook includes discussion related to Topic 840 (leases), which is superseded by Topic 842. Topic 842 is fully effective for public business entities, and the Codification excerpts are reproduced assuming adoption. Topic

842 is effective for other entities in the following periods (based on calendar year-ends) but can be early adopted. For the latest standard-setting activities related to Topic 842, see KPMG resource page on [Financial Reporting View](#).

	Public NFPs	Private companies
Annual periods	January 1, 2020	January 1, 2022
Interim periods	--	January 1, 2023

Other ASUs not fully effective

This Handbook incorporates a number of other amendments in Accounting Standards Updates that are not yet effective for all entities in all periods. These amendments do not have a significant effect on testing nonfinancial assets for impairment, and the Codification excerpts are reproduced as if the pending content were currently effective for all entities.

August 2023 edition

This edition of our Handbook has been updated to incorporate new or updated interpretive guidance on the principles of fair value measurement related to the measurement of a reporting unit's fair value in accordance with Topic 350. Compared to the July 2022 edition, a Question has been significantly updated or revised and is identified with #. This change is highlighted in the [Index of changes](#).

Abbreviations

We use the following abbreviations in this Handbook:

AOCI	Accumulated other comprehensive income
ARO	Asset retirement obligation
CODM	Chief operating decision maker
CTA	Cumulative translation adjustment
EBITDA	Earnings before interest, taxes, depreciation and amortization
IPR&D	In-process research and development
MD&A	Management's Discussion and Analysis
MPAP	Market participant acquisition premium
NCI	Noncontrolling interest
NFP	Not-for-profit entity
NOL	Net operating loss
OCI	Other comprehensive income
PP&E	Property, plant and equipment
RU	Reporting unit
WACC	Weighted average cost of capital

1. Executive summary

The following diagram is an overview of the different models for the impairment of nonfinancial assets: goodwill under Subtopic 350-20, indefinite-lived intangible assets under Subtopic 350-30, and long-lived assets (that are classified as held-and-used) under Topic 360. While each model is independent, they are also inextricably linked – containing overlapping concepts and requiring a specific sequence in impairment testing. This Handbook pulls together the three models to create a single roadmap to testing nonfinancial assets for impairment – with the content organized to compare and contrast the different models.

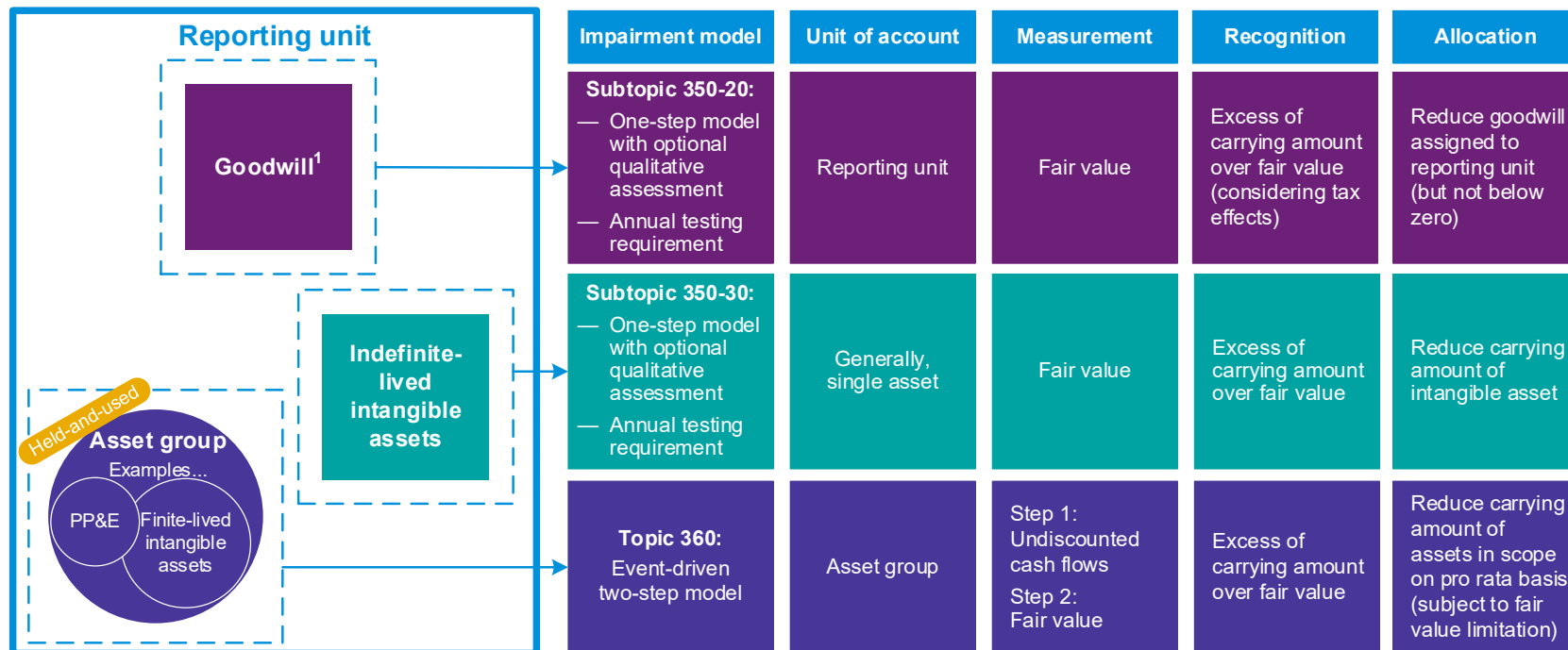

Note 1: Assumes (1) the entity has not elected the goodwill amortization accounting alternative (see chp 11); and (2) ASU 2017-04 has been adopted (see App A).

Scope of impairment models

Nonfinancial assets include assets such as land, buildings, equipment, right-of-use assets under leases (Topic 842), both finite- and indefinite-lived intangible assets and goodwill. An entity typically has a number of different types of nonfinancial assets and is required to evaluate each asset for impairment either on an annual basis and/or on the occurrence of certain impairment triggers (a trigger-based model).

Different Subtopics of the Codification apply to different types of nonfinancial assets, and the impairment models are different.

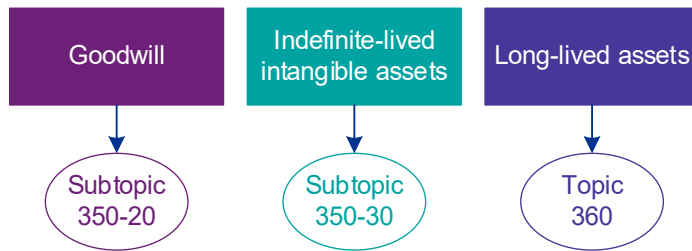

Read more: [Chapter 2](#)

The unit of account

The level at which nonfinancial assets are tested for impairment (i.e. the unit of account) differs under the three impairment models. For each type of nonfinancial asset, the following diagram shows the unit of account followed by a description.

Goodwill	Indefinite-lived intangible assets	Long-lived assets
Reporting unit	Generally, single asset	Asset group
An operating segment or a component of an operating segment	Or a group of indefinite-lived intangible assets if certain criteria are met	A group of assets and liabilities whose cash flows are largely independent

Units of account are not static. Before any impairment test, an entity determines if a unit of account has changed. Events such as reorganizations and disposal transactions occurring since the last impairment test may have changed a unit of account.

Read more: [Chapter 3](#)

When to test

When to test for impairment is dictated by the nature of the asset. The timing of an impairment test may be event-driven due to the existence of impairment indicators (e.g. operating losses) or may be performed on an annual basis as required by the relevant Subtopic.

For each type of nonfinancial asset, the following diagram highlights the number of steps in the impairment model and the frequency of testing.

Goodwill	
One-step model with optional qualitative assessment	<ul style="list-style-type: none"> — Test annually — Test when trigger exists with some relief for private companies and NFPs
Indefinite-lived intangible assets	
One-step model with optional qualitative assessment	<ul style="list-style-type: none"> — Test annually — Test when trigger exists
Long-lived assets	
Two-step model	Test when trigger exists

Regardless of why an impairment test is performed, the sequencing is based on the nature of the asset as shown in the following diagram.

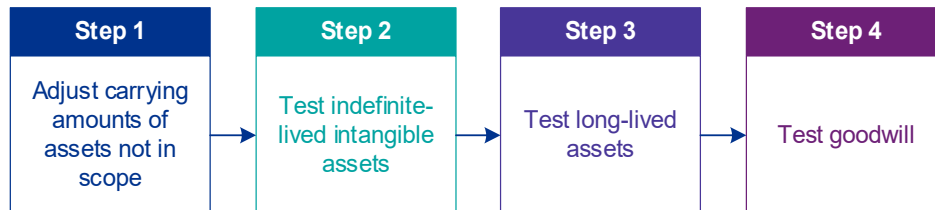

Read more: [Chapter 4](#)

Carrying amount

For an indefinite-lived intangible asset, determining the unit of account is straightforward – comprising the carrying amount of one or more indefinite-lived intangible assets.

For goodwill impairment testing, criteria apply in assigning assets and liabilities to one or more reporting units; these are based on the assets and liabilities used in operations and how fair value will be measured.

For long-lived assets, there is limited guidance on determining the carrying amount of the asset group. Instead, the focus is on symmetry with the cash flows used to test for impairment – to ensure that the comparison of the carrying amount with the future estimated cash flows is on a like-for-like basis.

Read more: [Chapter 5](#)

Qualitative assessment

Applies to: goodwill and indefinite-lived intangible assets.

An entity may elect to perform a qualitative assessment to determine if it's not more likely than not that a reporting unit (or indefinite-lived intangible asset) is impaired. As such, the optional qualitative assessment acts as a screen for determining if it is necessary to perform the quantitative test.

If the qualitative assessment is elected, we recommend following a systematic approach, such as the following model.

Step 1	Develop a framework to determine when the entity will perform a qualitative assessment and when it will proceed directly to the quantitative test.
Step 2	If a qualitative assessment will be performed, consider the most recent fair value measurement and when that measurement was determined.
Step 3	Identify the significant drivers of fair value .
Step 4	Determine what events and circumstances have occurred that may have affected those drivers of fair value, including positive and mitigating events and circumstances.
Step 5	Assess the likely impact of the factors identified in the previous steps on the fair value.
Step 6	Consider any transactions or events that significantly affected the carrying amount.
Step 7	Prepare an analysis based on the events, circumstances and factors identified and document the assessment of whether it is more likely than not that fair value is less than the carrying amount.

Read more: [Chapter 6](#)

Recoverability test

Applies to: long-lived assets.

A recoverability test for long-lived assets is required when the entity concludes that there has been an event or change in circumstances that indicates that the carrying amount of an asset may not be recoverable.

The outcome of the recoverability test (referred to as Step 1) is used to evaluate whether the asset group is impaired.

As shown in the diagram, Step 1 compares the undiscounted estimated future cash flows to the carrying amount of the asset group. If the cash flows exceed the carrying amount, there is no impairment. If the cash flows are less than the

carrying amount, the entity proceeds to Step 2 and measures the fair value of the asset group.

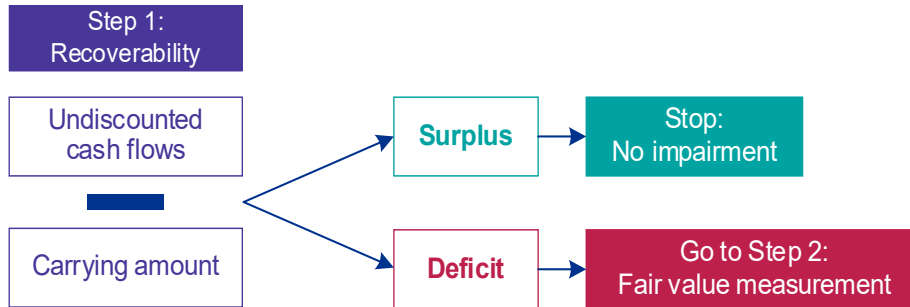

Read more: [Chapter 7](#)

Fair value measurement

For all three impairment models, impairment is calculated by reference to fair value, which is measured in accordance with Topic 820. Fair value is the price that would be received to sell an asset or paid to transfer a liability in an orderly transaction between market participants at the measurement date; the entity's own assumptions are not relevant.

The following summarizes the circumstances that cause an entity to arrive at the need to measure fair value and calculate the amount of any impairment loss.

— Goodwill and indefinite-lived intangible assets:

- the entity performed a qualitative assessment and concluded it was more likely than not that the asset was impaired – i.e. the entity could not avoid the annual quantitative test;
- the entity did not perform a qualitative assessment, and instead proceeded directly to the annual quantitative test; or
- outside of the annual testing, the entity concluded that it was more likely than not that the asset was impaired.

— Long-lived assets:

- based on one or more indicators of impairment, the entity concluded that the carrying amount of an asset group might not be recoverable; and
- the Step 1 recoverability test failed.

Under each model, if fair value is less than the carrying amount of the relevant unit of account, that deficit is the amount of the impairment loss – subject to the limitation that goodwill cannot be reduced below zero.

Read more: [Chapter 8](#)

Recognition and allocation

For each type of nonfinancial asset, the following diagram shows how the impairment loss is allocated and the limitations.

Goodwill	Indefinite-lived intangible assets	Long-lived assets
Reporting unit	Generally, single asset	Asset group
Reduce the carrying amount of goodwill, but not below zero	Reduce the carrying amount of the intangible asset	<ul style="list-style-type: none"> — Reduce the carrying amount of the assets in the scope of the impairment model on a pro rata basis — No individual long-lived asset is reduced below its fair value (if determinable without undue cost and effort)

Read more: [Chapter 9](#)

Disclosures

The disclosure requirements related to impairment testing come from three main sources.

Topics 350 and 360	Topic 820	Topic 275
Similar disclosures for all impaired nonfinancial assets	Information about the fair value measurement that is the basis for the impairment loss	Disclosures about risks and uncertainties – e.g. potential future impairment
Examples: <ul style="list-style-type: none"> — Amount of impairment loss — Description of impaired asset — Facts and circumstances that led to impairment 	Examples: <ul style="list-style-type: none"> — Description of valuation technique(s) and inputs used — Changes to technique(s) and reasons therefor 	Disclose if: <ul style="list-style-type: none"> — reasonably possible of occurring; — would occur in the near term; and — effect would be material to the financial statements

In addition, SEC registrants are expected to make more granular disclosures in MD&A.

Read more: [Chapter 10](#)

2. Scope of impairment models

Detailed contents

2.1 How the standards work

2.2 Finite- vs indefinite-lived intangible assets

Questions

2.2.10 When does an intangible asset have an indefinite useful life?

2.2.20 When and how is an intangible asset reclassified?

2.3 Indefinite-lived intangible assets

Question

2.3.10 Is acquired IPR&D an indefinite-lived intangible asset?

2.4 Long-lived assets

Questions

2.4.10 When is a long-lived asset considered to be 'held and used'?

2.4.20 If an asset is outside the scope of Topic 360, is it ignored in applying the impairment model?

2.4.30 Are internal-use software and cloud computing implementation cost assets in the scope of the Topic 360 impairment model?

2.4.40 Is an equity method investment in the scope of the Topic 360 impairment model?

2.4.50 Which impairment model applies to defensive intangible assets?

2.5 Goodwill

2.1 How the standards work

Nonfinancial assets include assets such as land, buildings, equipment, right-of-use assets under leases (Topic 842), both finite- and indefinite-lived intangible assets and goodwill. An entity typically has a number of different types of nonfinancial assets and is required to evaluate each asset for impairment either on an annual basis and/or on the occurrence of certain impairment triggers (a trigger-based model).

Different Subtopics of the Codification apply to different types of nonfinancial assets, and the impairment models are different. For example, goodwill is assessed for impairment at the reporting unit level, while long-lived assets are assessed at the asset group level. Notwithstanding the different models, there are elements of commonality and interdependencies that are discussed throughout this Handbook.

The following diagram is an excerpt from the full impairment diagram in [chapter 1](#), showing the model used for each type of nonfinancial asset. The diagram highlights the importance of distinguishing finite- from indefinite-lived intangible assets.

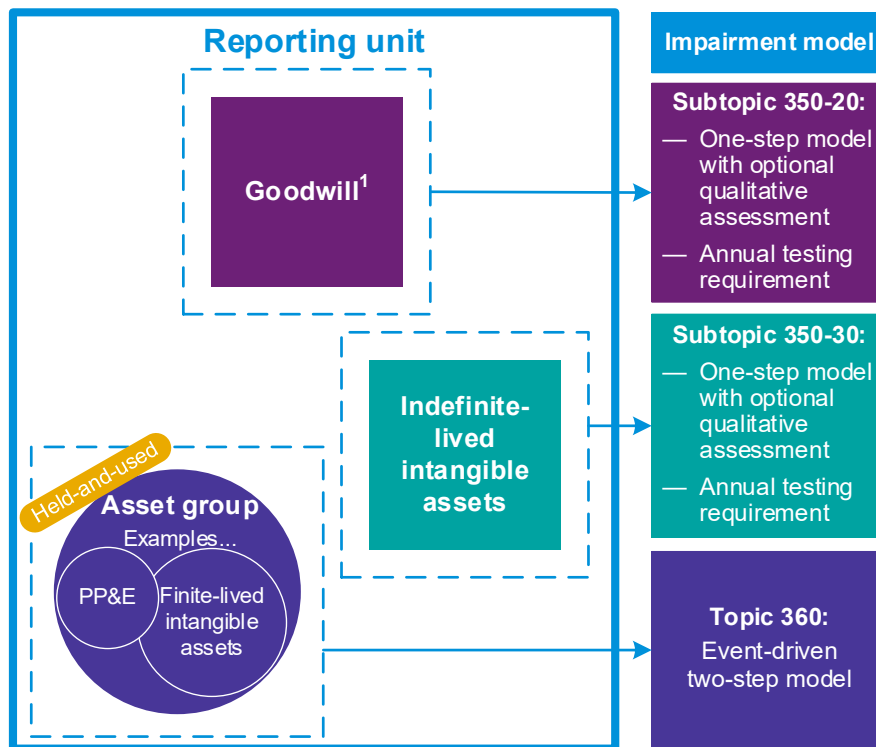

Note 1: Assumes (1) the entity has not elected the goodwill amortization accounting alternative (see chapter 11); and (2) ASU 2017-04 has been adopted (see Appendix A).

2.2 Finite- vs indefinite-lived intangible assets



Excerpt from ASC 350-30

> Determining the Useful Life of an Intangible Asset

35-2 The useful life of an intangible asset to an entity is the period over which the asset is expected to contribute directly or indirectly to the future cash flows of that entity. The useful life is not the period of time that it would take that entity to internally develop an intangible asset that would provide similar benefits. However, a reacquired right recognized as an intangible asset is amortized over the remaining contractual period of the contract in which the right was granted. If an entity subsequently reissues (sells) a reacquired right to a third party, the entity includes the related unamortized asset, if any, in determining the gain or loss on the reissuance.

35-3 The estimate of the useful life of an intangible asset to an entity shall be based on an analysis of all pertinent factors, in particular, all of the following factors with no one factor being more presumptive than the other:

- a. The expected use of the asset by the entity.
- b. The expected useful life of another asset or a group of assets to which the useful life of the intangible asset may relate.
- c. Any legal, regulatory, or contractual provisions that may limit the useful life. The cash flows and useful lives of intangible assets that are based on legal rights are constrained by the duration of those legal rights. Thus, the useful lives of such intangible assets cannot extend beyond the length of their legal rights and may be shorter.
- d. The entity's own historical experience in renewing or extending similar arrangements, consistent with the intended use of the asset by the entity, regardless of whether those arrangements have explicit renewal or extension provisions. In the absence of that experience, the entity shall consider the assumptions that market participants would use about renewal or extension consistent with the highest and best use of the asset by market participants, adjusted for entity-specific factors in this paragraph.
- e. The effects of obsolescence, demand, competition, and other economic factors (such as the stability of the industry, known technological advances, legislative action that results in an uncertain or changing regulatory environment, and expected changes in distribution channels)
- f. The level of maintenance expenditures required to obtain the expected future cash flows from the asset (for example, a material level of required maintenance in relation to the carrying amount of the asset may suggest a very limited useful life). As in determining the useful life of depreciable tangible assets, regular maintenance may be assumed but enhancements may not.

Further, if an income approach is used to measure the fair value of an intangible asset, in determining the useful life of the intangible asset for amortization purposes, an entity shall consider the period of expected cash flows used to measure the fair value of the intangible asset adjusted as appropriate for the entity-specific factors in this paragraph.

35-4 If no legal, regulatory, contractual, competitive, economic, or other factors limit the useful life of an intangible asset to the reporting entity, the useful life of the asset shall be considered to be indefinite. The term *indefinite* does not mean the same as infinite or indeterminate. The useful life of an intangible asset is indefinite if that life extends beyond the foreseeable horizon—that is, there is no foreseeable limit on the period of time over which it is expected to contribute to the cash flows of the reporting entity. Such intangible assets might be airport route authorities, certain trademarks, and taxicab medallions.

- > Intangible Assets Subject to Amortization

35-10 An intangible asset that initially is deemed to have a finite useful life shall cease being amortized if it is subsequently determined to have an indefinite useful life, for example, due to a change in legal requirements. If an intangible asset that is being amortized is subsequently determined to have an indefinite useful life, the asset shall be tested for impairment in accordance with paragraphs 350-30-35-18 through 35-20.

35-11 Any resulting impairment loss would be due to a change in accounting estimate and thus, consistent with Topic 250, shall be recognized as a change in estimate, not as a change in accounting principle. Therefore, that loss shall be presented in the income statement in the same manner as other impairment losses.

35-12 That intangible asset shall no longer be amortized and shall be accounted for in the same manner as other intangible assets that are not subject to amortization.

35-13 When an intangible asset's useful life is no longer considered to be indefinite, such as when unanticipated competition enters the market, the intangible asset must be amortized over the remaining period that it is expected to contribute to cash flows.

35-14 An intangible asset that is subject to amortization shall be reviewed for impairment in accordance with the Impairment or Disposal of Long-Lived Assets Subsections of Subtopic 360-10 by applying the recognition and measurement provisions in paragraphs 360-10-35-17 through 35-35. In accordance with the Impairment or Disposal of Long-Lived Assets Subsections of Subtopic 360-10, an impairment loss shall be recognized if the carrying amount of an intangible asset is not recoverable and its carrying amount exceeds its fair value. After an impairment loss is recognized, the adjusted carrying amount of the intangible asset shall be its new accounting basis. Subsequent reversal of a previously recognized impairment loss is prohibited.

- > Intangible Assets Not Subject to Amortization

35-15 If an intangible asset is determined to have an indefinite useful life, it shall not be amortized until its useful life is determined to be no longer indefinite.

35-16 An entity shall evaluate the remaining useful life of an intangible asset that is not being amortized each reporting period to determine whether events and circumstances continue to support an indefinite useful life.

The nature of an intangible asset drives the applicable impairment model. The impairment model under Topic 360 applies to long-lived assets, including finite-lived intangible assets. Subtopic 350-30 applies to indefinite-lived intangible assets (other than goodwill). Therefore, to test an intangible asset for impairment, an entity first needs to determine whether it is a finite-lived or an indefinite-lived intangible asset.

<p>Finite-lived intangible asset</p>	<p>A finite-lived intangible asset has a limited useful life. The useful life is the period over which the intangible asset is expected to contribute directly or indirectly to the entity’s future cash flows. [350-30-35-2]</p>
<p>Indefinite-lived intangible asset</p>	<p>An indefinite-lived intangible asset has no legal, regulatory, contractual, competitive, economic or other factors limiting its life. An indefinite useful life extends beyond the foreseeable horizon; there is no foreseeable limit on the period of time over which the asset is expected to contribute to the entity’s cash flows. [350-30-35-4]</p>

An entity reassesses its classification of an indefinite-lived intangible asset each reporting period. It reclassifies an indefinite-lived intangible asset as a finite-lived intangible asset if the facts and circumstances no longer suggest that the asset’s life is indefinite. [350-30-35-16]

 **Question 2.2.10**
When does an intangible asset have an indefinite useful life?

Interpretive response: Unless an intangible asset’s life extends beyond the foreseeable horizon, an entity is required to assign it a useful life – even if a precise useful life for the asset cannot be determined. In such cases, the entity uses its best estimate of the intangible asset’s useful life.

For example, the useful life of a patent can typically be determined with precision because a patent has a clear expiration date under US federal law and cannot be renewed. In contrast, the useful life of magazine subscriber relationships typically cannot be easily determined because an unknown number of subscribers will renew their current subscriptions. In the case of subscribers, the entity needs to estimate the period over which the underlying relationships will continue. This can be difficult and requires judgment based on the individual facts and circumstances; however, the SEC staff has stated that it would be extremely rare for any type of customer relationship intangible to have an indefinite life. [2003 AICPA Conf]

As another example, airport slotting rights are also renewable when their contractual period expires. In contrast to the magazine subscriber relationships, an airline is likely to find it easier to determine that renewals will occur indefinitely – i.e. beyond the foreseeable horizon. This is because of long-standing industry practice of airlines being offering renewals to slotting rights given their critical nature to the airlines’ operations. In that case, the slotting rights may be indefinite-lived intangible assets.

For further discussion of how to determine whether an intangible asset has an indefinite useful life, see KPMG Handbook, [Business combinations](#).



Question 2.2.20

When and how is an intangible asset reclassified?

Interpretive response: The reclassification of an intangible asset depends on whether the asset was initially classified as finite- or indefinite-lived.

Finite-lived to indefinite-lived

When a finite-lived intangible asset is subsequently determined to have an indefinite life, it is accounted for as follows as a change in estimate: [250-10-45-17, 350-30-35-10 – 35-12]

- the carrying amount of the intangible asset ceases to be amortized and must be tested for impairment at that point – i.e. a quantitative test is required unless the entity chooses to carry out (and passes) a qualitative assessment (see [Question 4.2.30](#)); and
- thereafter the intangible asset is tested for impairment in the same way as other indefinite-lived intangible assets.

Some mature products and brand names might be considered to have indefinite lives. In contrast, a young brand or product typically has a finite useful life initially, but the passage of time and more evidence might lead to a conclusion that the life has changed to indefinite. For example, an acquired brand name that has only been in the market for a few years would likely not be considered to have an indefinite life, but after a longer history of stable cash flows that conclusion might change. However, in our experience, it is uncommon for finite-lived intangible assets to become indefinite-lived intangible assets.

Indefinite-lived to finite-lived

Conversely, an indefinite-lived intangible asset may subsequently be determined to have a finite useful life. In this case, the intangible asset's carrying amount is first tested for impairment under Subtopic 350-30 – i.e. a quantitative test is required unless the entity chooses to carry out (and passes) a qualitative assessment (see [Question 4.2.30](#)). [350-30-35-13, 35-15 – 35-16]

Then the entity amortizes the remaining carrying amount over the new estimated useful life. Subsequently, the asset is tested for impairment under Topic 360 at each reporting date if a triggering event has occurred. [350-30-35-17]

2.3 Indefinite-lived intangible assets



Excerpt from ASC 350-30

- > Intangible Assets Not Subject to Amortization

35-17 If an intangible asset that is not being amortized is subsequently determined to have a finite useful life, the asset shall be tested for impairment in accordance with paragraphs 350-30-35-18 through 35-19. That intangible asset shall then be amortized prospectively over its estimated remaining useful life and accounted for in the same manner as other intangible assets that are subject to amortization.

35-17A Intangible assets acquired in a business combination or an acquisition by a not-for-profit entity that are used in research and development activities (regardless of whether they have an alternative future use) shall be considered indefinite lived until the completion or abandonment of the associated research and development efforts. During the period that those assets are considered indefinite lived, they shall not be amortized but shall be tested for impairment in accordance with paragraphs 350-30-35-18 through 35-19. Once the research and development efforts are completed or abandoned, the entity shall determine the useful life of the assets based on the guidance in this Section. Consistent with the guidance in paragraph 360-10-35-49, intangible assets acquired in a business combination or an acquisition by a not-for-profit entity that have been temporarily idled shall not be accounted for as if abandoned.

Indefinite-lived intangible assets are tested for impairment under Subtopic 350-30 on an annual basis, but more frequently if a triggering event occurs. An impairment loss is incurred when the carrying amount of the asset is greater than its fair value; the excess is the impairment loss recognized. [350-30-35-18 – 35-18A, 35-19]



Question 2.3.10

Is acquired IPR&D an indefinite-lived intangible asset?

Interpretive response: In-process R&D (IPR&D) acquired in a business combination is generally considered an indefinite-lived intangible asset until completion or abandonment of the related R&D efforts. During this period, IPR&D is tested for impairment under the indefinite-lived intangible asset impairment model in Subtopic 350-30. [350-30-35-17A]

The following diagram highlights the accounting for IPR&D each period.

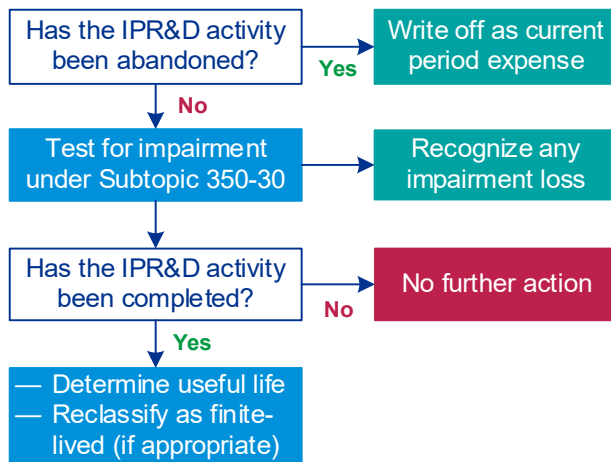

As an exception to the general model, when IPR&D acquired in a business combination is intended to be used for defensive purposes, the accounting depends on what the acquired IPR&D is intended to defend.

- If the IPR&D asset is acquired to protect an existing, ongoing R&D project of the acquirer, the acquired IPR&D is accounted for as outlined above.
- However, if the IPR&D asset is acquired to defend an existing, completed product of the acquirer, and further development of the acquired IPR&D is not planned, its useful life is determined and it is amortized over that period; accordingly, the IPR&D would be a long-lived asset (see [Question 2.4.50](#)).

2.4 Long-lived assets



Excerpt from ASC 360-10

> Transactions

15-4 The guidance in the Impairment or Disposal of Long-Lived Assets Subsections applies to the following transactions and activities:

- a. Except as indicated in (b) and the following paragraph, all of the transactions and activities related to recognized long-lived assets of an entity to be held and used or to be disposed of, including:
 1. Right-of-use assets of lessees
 2. Long-lived assets of lessors subject to operating leases
 3. Proved oil and gas properties that are being accounted for using the successful-efforts method of accounting
 4. Long-term prepaid assets.

15-5 The guidance in the Impairment or Disposal of Long-Lived Assets Subsections does not apply to the following transactions and activities:

- a. Goodwill
- b. Intangible assets not being amortized that are to be held and used
- c. Servicing assets
- d. Financial instruments, including investments in equity securities accounted for under the cost or equity method
- e. Deferred policy acquisition costs
- f. Deferred tax assets
- g. Unproved oil and gas properties that are being accounted for using the successful-efforts method of accounting
- h. Oil and gas properties that are accounted for using the full-cost method of accounting as prescribed by the Securities and Exchange Commission (SEC) (see Regulation S-X, Rule 4-10, Financial Accounting and Reporting for Oil and Gas Producing Activities Pursuant to the Federal Securities Laws and the Energy Policy and Conservation Act of 1975)
- i. Certain other long-lived assets for which the accounting is prescribed elsewhere in the standards:
 1. For guidance on financial reporting in the record and music industry, see Topic 928.
 2. For guidance on financial reporting in the broadcasting industry, see Topic 920
 3. For guidance on accounting for the costs of computer software to be sold, leased, or otherwise marketed, see Subtopic 985-20.
 4. For guidance on accounting for abandonments and disallowances of plant costs for regulated entities, see Subtopic 980-360.

> Long-Lived Assets to Be Exchanged or to Be Distributed to Owners in a Spinoff

40-4 For purposes of this Subtopic, a long-lived asset to be disposed of in an exchange measured based on the recorded amount of the nonmonetary asset relinquished or to be distributed to owners in a spinoff is disposed of when it is exchanged or distributed. If the asset (**asset group**) is tested for recoverability while it is classified as held and used, the estimates of future cash flows used in that test shall be based on the use of the asset for its remaining useful life, assuming that the disposal transaction will not occur. In such a case, an undiscounted cash flows recoverability test shall apply prior to the disposal date. In addition to any **impairment** losses required to be recognized while the asset is classified as held and used, an impairment loss, if any, shall be recognized when the asset is disposed of if the carrying amount of the asset (**disposal group**) exceeds its fair value. The provisions of this Section apply to nonmonetary exchanges that are not recorded at fair value under the provisions of Topic 845.

Long-lived assets in the scope of the Topic 360 impairment model include PP&E, long-lived assets of lessors that are subject to operating leases (Topics 840 and 842), and right-of-use assets (Topic 842) or capital lease assets (Topic 840) of lessees; they do not include operating leases assets of lessees (Topic 840). Finite-lived intangible assets are also tested for impairment under this model. [360-10-15-4]

These assets are subject to the Topic 360 impairment model only if they are classified as held-and-used. In contrast, if they are classified as held-for-sale then they are measured at the lower of their carrying amount and fair value less cost to sell. The classification of assets as held-for-sale is discussed in KPMG Handbook, [Discontinued operations and held-for-sale disposal groups](#). [360-10-35-43]



Question 2.4.10

When is a long-lived asset considered to be 'held and used'?

Interpretive response: An asset held-and-used is an asset that an entity: [360-10-15-4 – 15-5, 40-4]

- uses in operations and does not plan to sell;
- plans to sell but does not yet satisfy the conditions in paragraph 360-10-45-9 to be classified as held-for-sale; or
- plans to abandon, dispose of in an exchange measured at its recorded amount, or distribute to owners in a spinoff.

The classification of assets as held-for-sale is discussed in KPMG Handbook, [Discontinued operations and held-for-sale disposal groups](#).



Question 2.4.20

If an asset is outside the scope of Topic 360, is it ignored in applying the impairment model?

Interpretive response: No. Assets can be drawn into the Topic 360 impairment model in two ways.

- They are directly in scope – either because Topic 360 specifies it, or because another Subtopic requires them to be tested for impairment under the Topic 360 impairment model.
 - Their cash flows are an integral part of the cash flows of the unit of account (asset group) – i.e. they are part of a group of assets and liabilities at the lowest level for which identifiable cash flows are largely independent of the cash flows of other assets and liabilities. In that case, they are included for purposes of identifying and measuring an impairment loss, which is then allocated only to assets that are long-lived assets (see [Question 9.3.10](#)).
-



Question 2.4.30

Are internal-use software and cloud computing implementation cost assets in the scope of the Topic 360 impairment model?

Interpretive response: Yes. The impairment model under Topic 360 applies to the following: [350-40-35-1, 35-11]

- internal-use software assets in the scope of Subtopic 350-40; and
- implementation costs deferred by a customer in a cloud computing arrangement.



Question 2.4.40

Is an equity method investment in the scope of the Topic 360 impairment model?

Interpretive response: No. Equity method investments are excluded from the scope of the Topic 360 impairment model. Instead, they are evaluated for impairment under Subtopic 323-10; see section 5.5 of KPMG Handbook, [Equity method of accounting](#). [360-10-15-5(d)]

However, an impairment loss recognized by an equity method investee on its own long-lived assets may need to be adjusted by the investor for basis differences recognized in applying the equity method. This is discussed in Question 5.5.40 of our equity method handbook.



Question 2.4.50

Which impairment model applies to defensive intangible assets?



Excerpt from ASC 350-30

20 Glossary

Defensive Intangible Asset

An acquired intangible asset in a situation in which an entity does not intend to actively use the asset but intends to hold (lock up) the asset to prevent others from obtaining access to the asset.

- > Defensive Intangible Assets

35-5A This guidance addresses the application of paragraphs 350-30-35-1 through 35-4 to a defensive intangible asset other than an intangible asset that is used in research and development activities. A defensive intangible asset shall be assigned a useful life that reflects the entity's consumption of the expected benefits related to that asset. The benefit a reporting entity receives

from holding a defensive intangible asset is the direct and indirect cash flows resulting from the entity preventing others from realizing any value from the intangible asset (defensively or otherwise). An entity shall determine a defensive intangible asset's useful life, that is, the period over which an entity consumes the expected benefits of the asset, by estimating the period over which the defensive intangible asset will diminish in fair value. The period over which a defensive intangible asset diminishes in fair value is a proxy for the period over which the reporting entity expects a defensive intangible asset to contribute directly or indirectly to the future cash flows of the entity.

35-5B It would be rare for a defensive intangible asset to have an indefinite life because the fair value of the defensive intangible asset will generally diminish over time as a result of a lack of market exposure or as a result of competitive or other factors. Additionally, if an acquired intangible asset meets the definition of a defensive intangible asset, it shall not be considered immediately abandoned.

Background: A defensive intangible asset is one that an entity acquires to block others from using it. For an intangible asset to be classified as defensive, at the date of acquisition, it must be the entity's intention not to actively use the asset. For example, if an entity purchases a competitor and plans to stop using the competitor's brand names, the entity classifies those acquired brand names as defensive assets. [\[350-30 Glossary\]](#)

Interpretive response: In almost all cases, a defensive intangible asset is subject to the Topic 360 impairment model for long-lived assets. The following table highlights the accounting that leads to this outcome. [\[350-30-35-5A – 35-5B\]](#)

<p>Recognize the asset acquired</p>	<ul style="list-style-type: none"> — If the asset is acquired in a business combination, the acquisition method in Subtopic 805-10 applies. See section 12 of KPMG Handbook, Business combinations. — If the asset is acquired in an asset acquisition, the allocation model in Subtopic 805-50 applies. See section 4.2 of KPMG Handbook, Asset acquisitions.
<p>Determine the asset's useful life¹</p>	<ul style="list-style-type: none"> — The useful life is the estimated period over which the entity will receive benefits from holding the asset. — The benefits are the direct and indirect cash flows resulting from the entity preventing others from realizing any value from the asset.
<p>Amortize the asset over its useful life</p>	<ul style="list-style-type: none"> — The asset is amortized over its useful life. — Even though the entity will not actively use the asset in its operations, it is not permitted to treat the asset as abandoned; therefore, an immediate writeoff is prohibited.
<p>Note:</p> <p>1. A defensive intangible asset will rarely have an indefinite useful life.</p>	

As an exception to the above general principles, if IPR&D is acquired to protect an existing, ongoing R&D project of the acquirer, it is accounted for in the same way as an indefinite-lived intangible asset until completion or abandonment of the R&D project (see [Question 2.3.10](#)).

2.5 Goodwill



Excerpt from ASC 805-30

20 Glossary

Goodwill

An asset representing the future economic benefits arising from other assets acquired in a business combination or an acquisition by a not-for-profit entity that are not individually identified and separately recognized. For ease of reference, this term also includes the immediate charge recognized by not-for-profit entities in accordance with paragraph 958-805-25-29.

> Measurement of Goodwill

30-1 The **acquirer** shall recognize **goodwill** as of the **acquisition date**, measured as the excess of (a) over (b):

- a. The aggregate of the following:
 1. The consideration transferred measured in accordance with this Section, which generally requires acquisition-date **fair value** (see paragraph 805-30-30-7)
 2. The fair value of any **noncontrolling interest** in the **acquiree**
 3. In a **business combination** achieved in stages, the acquisition-date fair value of the acquirer's previously held equity interest in the acquiree.
- b. The net of the acquisition-date amounts of the **identifiable** assets acquired and the liabilities assumed measured in accordance with this Topic.



Excerpt from ASC 350-20

> Overall Accounting for Goodwill

35-1 Goodwill shall not be amortized. Instead, goodwill shall be tested at least annually for impairment at a level of reporting referred to as a **reporting unit**. (Paragraphs 350-20-35-33 through 35-46 provide guidance on determining reporting units.)

35-2 Impairment of goodwill is the condition that exists when the carrying amount of a reporting unit that includes goodwill exceeds its fair value. A goodwill impairment loss is recognized for the amount that the carrying amount of a reporting unit, including goodwill, exceeds its fair value, limited to the total amount of goodwill allocated to that reporting unit. However, an entity

shall consider the related income tax effect from any tax deductible goodwill, if applicable, in accordance with paragraph 350-20-35-8B when measuring the goodwill impairment loss.

The impairment model under Subtopic 350-20 applies to goodwill. Goodwill is an asset representing future economic benefits arising from operations acquired in a business combination that are not individually identified and separately recognized. It does not arise in an asset acquisition. Essentially, it is the residual amount remaining after the consideration in a business combination (adjusted for certain items) has been assigned to the identifiable assets acquired and liabilities assumed based generally on their acquisition-date fair values. For further discussion, see section 22 of KPMG Handbook, [Business combinations](#). [805-30 Glossary, 805-30-30-1]

3. The unit of account

Detailed contents

3.1 How the standards work

3.2 Indefinite-lived intangible assets: generally, single asset

- 3.2.10 Overview
- 3.2.20 Combining intangible assets
- 3.2.30 Examples
- 3.2.40 Restrictions in combining intangible assets

Questions

- 3.2.10 What are the indicators to help determine whether indefinite-lived intangible assets are a single unit of account?
- 3.2.20 How is the 'highest and best use' indicator applied in practice?
- 3.2.30 When does a marketing or brand strategy provide evidence that intangible assets are complementary?
- 3.2.40 Can a unit of account comprise indefinite-lived intangible assets owned by different subsidiaries?
- 3.2.50 How often is the unit of account for indefinite-lived intangible assets reassessed?
- 3.2.60 Can the unit of account for testing indefinite-lived assets for impairment also include finite-lived intangible assets?
- 3.2.70 Can a unit of account comprise the entire business?
- 3.2.80 How is the 'different asset groups' indicator applied?

Examples

- 3.2.10 'Highest and best use' indicator
- 3.2.20 Consolidated vs stand-alone financial statements

3.3 Long-lived assets: asset group

- 3.3.10 Overview
- 3.3.20 Asset group vs reporting unit
- 3.3.30 Determining the asset group
- 3.3.40 Enterprise assets
- 3.3.50 Revising asset groups

Questions

- 3.3.10 What is the difference between an asset group and a reporting unit?

- 3.3.20 How does an entity determine asset groups?
- 3.3.30 How are asset groups determined when contractual limitations create revenue dependency?
- 3.3.40 How are asset groups determined by a retailer that has some unprofitable stores?
- 3.3.50 Can assets be grouped at a higher level when different operational assets are interchangeable?
- 3.3.60 Can assets be grouped at a higher level when output can be shifted between production facilities?
- 3.3.70 How are asset groups determined when costs are shared across operations vs direct costs allocated simply for administrative convenience?
- 3.3.80 How are asset groups determined when shared costs are unrelated to operations?
- 3.3.90 How is the unit of account for an enterprise asset determined?
- 3.3.100 Can a retailer's flagship store be considered an enterprise asset?
- 3.3.110 When are asset groups revised, and how is a change accounted for?
- 3.3.120 Does the sale of part of an asset group indicate that asset groups should be identified at a lower level?
- 3.3.130 Does the potential sale of part of a retail group result in a change in asset groups?
- 3.3.140 Does the potential forfeiture of part of an asset group affect the remaining part of the group?

Examples

- 3.3.10 Determining asset groups when some operations are unprofitable
- 3.3.20 Identifying enterprise assets
- 3.3.30 Impact of a change in asset grouping

3.4 Goodwill: reporting unit

- 3.4.10 Overview
- 3.4.20 Component criterion 1: A business for which discrete financial information is available
- 3.4.30 Component criterion 2: Segment management regularly reviews the operating results
- 3.4.40 Component criterion 3: Different economic characteristics
- 3.4.50 Revising reporting units

Questions

- 3.4.10 What are the building blocks for determining reporting units?
- 3.4.20 Does an entity that does not provide segment disclosures have to identify operating segments?
- 3.4.30 What is the relationship between operating segments, reportable segments and reporting units?
- 3.4.40 Is an entity's legal structure relevant in determining reporting units?
- 3.4.50 When is a component a business?
- 3.4.60 When is discrete financial information available for a component?
- 3.4.70 What is the difference between the CODM and a segment manager?
- 3.4.80 What factors are considered in assessing whether components have similar economic characteristics?
- 3.4.90 Can components of different operating segments be aggregated into a single reporting unit if they are economically similar?
- 3.4.100 How do regular transfers of assets and liabilities between components affect the determination of reporting units?
- 3.4.110 When are reporting units revised, and how is a change accounted for?

Example

- 3.4.10 Identifying reporting units

3.1 How the standards work

The level at which nonfinancial assets are tested for impairment (i.e. the unit of account) differs under the three impairment models.

The following diagram is an adaptation of the impairment diagram in [chapter 1](#), showing the unit of account for each type of nonfinancial asset. The diagram highlights the importance of distinguishing finite- from indefinite-lived intangible assets.

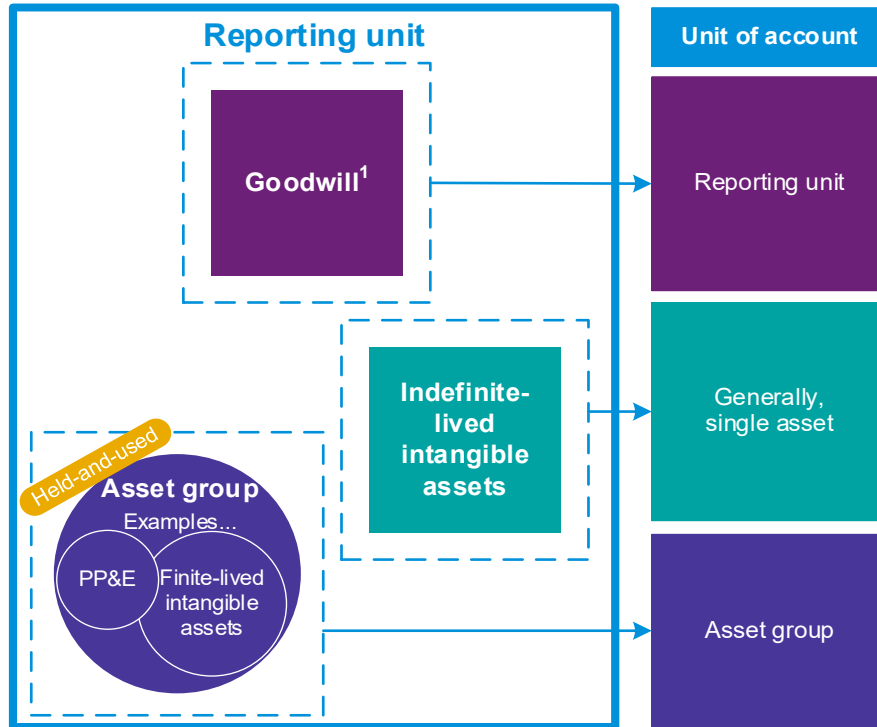

Note 1: Assumes (1) the entity has not elected the goodwill amortization accounting alternative (see chapter 11); and (2) ASU 2017-04 has been adopted (see Appendix A).

Units of account are not static. Before any impairment test, an entity determines if a unit of account has changed. Events such as reorganizations and disposal transactions occurring since the last impairment test may have changed a unit of account.

3.2 Indefinite-lived intangible assets: generally, single asset

3.2.10 Overview



Excerpt from ASC 350-30

> Unit of Accounting for Purposes of Testing for Impairment of Intangible Assets Not Subject to Amortization

35-21 Separately recorded indefinite-lived intangible assets, whether acquired or internally developed, shall be combined into a single unit of accounting for purposes of testing impairment if they are operated as a single asset and, as such, are essentially inseparable from one another.

35-22 Determining whether several indefinite-lived intangible assets are essentially inseparable is a matter of judgment that depends on the relevant facts and circumstances. The indicators in paragraph 350-30-35-23 shall be considered in making that determination. None of the indicators shall be considered presumptive or determinative.

35-23 Indicators that two or more indefinite-lived intangible assets shall be combined as a single unit of accounting for impairment testing purposes are as follows:

- a. The intangible assets were purchased in order to construct or enhance a single asset (that is, they will be used together).
- b. Had the intangible assets been acquired in the same acquisition they would have been recorded as one asset.
- c. The intangible assets as a group represent the highest and best use of the assets (for example, they yield the highest price if sold as a group). This may be indicated if it is unlikely that a substantial portion of the assets would be sold separately or the sale of a substantial portion of the intangible assets individually would result in a significant reduction in the fair value of the remaining assets as a group.
- d. The marketing or branding strategy provides evidence that the intangible assets are complementary, as that term is used in paragraph 805-20-55-18.

35-24 Indicators that two or more indefinite-lived intangible assets shall not be combined as a single unit of accounting for impairment testing purposes are as follows:

- a. Each intangible asset generates cash flows independent of any other intangible asset (as would be the case for an intangible asset licensed to another entity for its exclusive use).
- b. If sold, each intangible asset would likely be sold separately. A past practice of selling similar assets separately is evidence indicating that combining assets as a single unit of accounting may not be appropriate.
- c. The entity has adopted or is considering a plan to dispose of one or more intangible assets separately.

- d. The intangible assets are used exclusively by different asset groups (see the Impairment or Disposal of Long-Lived Assets Subsections of Subtopic 360-10).
- e. The economic or other factors that might limit the useful economic life of one of the intangible assets would not similarly limit the useful economic lives of other intangible assets combined in the unit of accounting.

35-26 All of the following shall be included in the determination of the unit of accounting used to test indefinite-lived intangible assets for impairment:

- a. The unit of accounting shall include only indefinite-lived intangible assets—those assets cannot be tested in combination with **goodwill** or with a finite-lived asset.
- b. The unit of accounting cannot represent a group of indefinite-lived intangible assets that collectively constitute a business or a **nonprofit activity**.
- c. A unit of accounting may include indefinite-lived intangible assets recorded in the separate financial statements of consolidated subsidiaries. As a result, an impairment loss recognized in the consolidated financial statements may differ from the sum of the impairment losses (if any) recognized in the separate financial statements of those subsidiaries.

35-27 If, based on a change in the way in which intangible assets are used, an entity combines as a unit of accounting for impairment testing purposes indefinite-lived intangible assets that were previously tested for impairment separately, those intangible assets shall be separately tested for impairment in accordance with paragraphs 350-30-35-18 through 35-20 prior to being combined as a unit of accounting.

35-28 Examples 10 through 12 (see paragraphs 350-30-55-29 through 55-38) illustrate the determination of the unit of accounting to use in impairment testing.

The unit of account for the Subtopic 350-30 impairment test is a single indefinite-lived intangible asset unless a group of separately recorded indefinite-lived intangible assets are operated as a single asset – i.e. essentially inseparable from one another. [350-30-35-21]

3.2.20 Combining intangible assets

To determine the appropriate unit of account for indefinite-lived intangible assets, Subtopic 350-30 uses an indicator approach.



Question 3.2.10

What are the indicators to help determine whether indefinite-lived intangible assets are a single unit of account?

Interpretive response: As described below, Subtopic 350-30 lists indicators suggesting combination and other indicators suggesting the opposite. None of

the indicators are determinative and Subtopic 350-30 gives no weighting to any of them. [350-30-35-22 – 35-24]

Suggesting combination

- A.** The intangible assets were purchased to construct or enhance a single asset, meaning that they will be used together.
- B.** If the intangible assets had been acquired in the same transaction, they would have been recorded as one asset.
- C.** The highest and best use of the intangible assets is as a group – e.g. they would achieve the highest price if sold as a group. See [Question 3.2.20](#).
- D.** The marketing or branding strategy provides evidence that the intangible assets are complementary. See [Question 3.2.30](#).

Suggesting no combination

- E.** Each intangible asset generates cash flows independent of any other intangible asset – e.g. under a separate license.
- F.** If sold, each intangible asset would likely be sold separately. This may be evidenced by historical transactions.
- G.** The entity has adopted or is considering a plan to dispose of one or more intangible assets separately.
- H.** The intangible assets are used exclusively by different asset groups. For a discussion of asset groups, see [section 3.3](#).
- I.** The factors that might limit the useful economic life of one intangible asset would not similarly limit the useful economic lives of the other intangible assets.



Question 3.2.20

How is the 'highest and best use' indicator applied in practice?

Interpretive response: In assessing the 'highest and best use' indicator (Indicator C in [Question 3.2.10](#)), either of the following may indicate that the assets have the highest and best use as a group: [350-30-35-23(c)]

- it is unlikely that a substantial portion of the assets would be sold separately; or
- the sale of a substantial portion of the assets individually would significantly reduce the fair value of the remaining assets as a group.

[Example 3.2.10](#) illustrates several easements that are combined into a single unit of account.



Question 3.2.30

When does a marketing or brand strategy provide evidence that intangible assets are complementary?



Excerpt from ASC 805-20

••• > Trademarks, Trade Names, Service Marks, Collective Marks, Certification Marks

55-18 The terms *brand* and *brand name*, often used as synonyms for trademarks and other marks, are general marketing terms that typically refer to a group of complementary assets such as a trademark (or service mark) and its related trade name, formulas, recipes, and technological expertise. This Subtopic does not preclude an entity from recognizing, as a single asset separately from goodwill, a group of complementary intangible assets commonly referred to as a brand if the assets that make up that group have similar useful lives.

Interpretive response: The ‘complementary assets’ indicator (Indicator D in [Question 3.2.10](#)) is based on guidance in Topic 805 (business combinations) on assets that are associated with brands. That guidance permits such assets to be recognized as a single asset separate from goodwill in a business combination if the assets within the brand have similar useful lives. [\[805-20-55-18\]](#)

Although paragraph 805-20-55-18 permits complementary assets to be treated as a single asset (brand) in a business combination, the complementary assets indicator is just one indicator in determining the unit of account for impairment testing purposes. Therefore, it should be considered along with other relevant facts; see Example 12 in Subtopic 350-30, which is reproduced in [section 3.2.30](#). [\[350-30-35-22\]](#)

Further, Topic 805 applies the notion of complementary assets to assets acquired in the same business combination. The complementary asset indicator in the impairment test is broader in that it also applies to assets acquired in separate transactions or developed internally. [\[350-30-35-23\]](#)



Question 3.2.40

Can a unit of account comprise indefinite-lived intangible assets owned by different subsidiaries?

Interpretive response: Yes. Indefinite-lived intangible assets owned by different subsidiaries in a consolidated group may be combined into one unit of account if they are operated as a single asset (see [Question 3.2.10](#)). [\[350-30-35-26\(c\)\]](#)

This approach means that any impairment loss recognized in the consolidated financial statements may differ from the sum of any impairment losses in the stand-alone financial statements of the consolidated subsidiaries. [350-30-35-26(c)]

Example 11 in Subtopic 350-30 (reproduced in [section 3.2.30](#)) illustrates several tradenames that are combined into a single unit of account despite them being owned by different group entities, and [Example 3.2.20](#) illustrates the implications of that conclusion in the consolidated versus stand-alone financial statements.



Question 3.2.50

How often is the unit of account for indefinite-lived intangible assets reassessed?



Excerpt from ASC 350-30

> Unit of Accounting for Purposes of Testing for Impairment of Intangible Assets Not Subject to Amortization

35-27 If, based on a change in the way in which intangible assets are used, an entity combines as a unit of accounting for impairment testing purposes indefinite-lived intangible assets that were previously tested for impairment separately, those intangible assets shall be separately tested for impairment in accordance with paragraphs 350-30-35-18 through 35-20 prior to being combined as a unit of accounting.

Interpretive response: The determination of whether a group of indefinite-lived intangible assets is treated as a single asset for impairment purposes needs to be reassessed before each annual impairment test, as well as when a triggering event is identified – i.e. when there are events and changes in circumstances that indicate that it may be more likely than not that the asset is impaired; see [chapter 4](#). This ensures that the correct unit of account is tested for impairment.

An indefinite-lived intangible asset that was previously tested for impairment as a single asset may subsequently be combined with one or more other indefinite-lived intangible assets as a single unit of account. In that case, the asset is first tested for impairment as a single asset before being tested as part of the newly combined unit of account. See [Question 4.3.100](#). [350-30-35-27]

3.2.30 Examples



Example 3.2.10 'Highest and best use' indicator

ABC Corp. acquired perpetual right-of-way easements as part of its acquisition of DEF Corp. The easements have an indefinite life and allow ABC to run cable lines across several states, from City X to City Z. The easements were granted separately by each state and recorded as individual indefinite-lived intangible assets at the time of acquisition.

Because the easements are geographically connected and collectively support the infrastructure of the cable line network, none of the easements would be sold separately. Further, the initial fair value of the easements was based on their ability to connect an extensive geographic area. Therefore, if one of the easements was sold separately from the others, there would be a significant reduction in the fair value of the other easements.

For these reasons, ABC concludes that the easements should be combined into a single unit of account for impairment evaluation because this grouping represents the highest and best use of the assets.



Excerpt from ASC 350-30¹

> Example 10: Easements

55-29 This Example illustrates the guidance in paragraphs 350-30-35-21 through 35-24.

55-30 Entity A is a distributor of natural gas. Entity A has two self-constructed pipelines, the Northern pipeline and the Southern pipeline. Each pipeline was constructed on land for which Entity A owns perpetual easements that Entity A evaluated under Topic 842 and determined do not meet the definition of a **lease** under that Topic (because those easements are perpetual and, therefore, do not convey the right to use the underlying land for a period of time). The Northern pipeline was constructed on 50 easements acquired in 50 separate transactions. The Southern pipeline was constructed on 100 separate easements that were acquired in a business combination and were recorded as a single asset. Although each pipeline functions independently of the other, they are contained in the same **reporting unit**. Operation of each pipeline is directed by a different manager. There are discrete, identifiable cash flows for each pipeline; thus, each pipeline and its related easements represent a separate asset group under the Impairment or Disposal of Long-Lived Assets Subsections of Subtopic 360-10. While Entity A has no current plans to sell or otherwise dispose of any of its easements, Entity A believes that if either pipeline was sold, it would most likely convey all rights under the easements with the related pipeline.

55-31 Based on an evaluation of the circumstances, Entity A would have two units of accounting for purposes of testing the easements for impairment—the collection of easements supporting the Northern pipeline and the collection of easements supporting the Southern pipeline. The 50 easements supporting the Northern pipeline represent a single unit of accounting as evidenced by the fact that they are collectively used together in a single asset group (see paragraphs 360-10-35-23 through 35-26), if acquired in a single transaction, they would have been recorded as one asset, and if sold, they would likely be sold as a group with the related pipeline. For the same reasons, the easements supporting the Southern pipeline would represent a single unit of accounting.

55-32 Because the collective land easements underlying the Northern and Southern pipelines generate cash flows independent of one another and are used exclusively by separate asset groups under the Impairment or Disposal of Long-Lived Assets Subsections of Subtopic 360-10, they should not be combined into a single unit of accounting.

Note 1: Example 10 includes amendments related to Topic 842 (leases) that are discussed in Question 3.1.10 in KPMG Handbook, [Leases](#). Those amendments require an entity to consider whether the easements meet the definition of a lease under Topic 842, but they do not affect the unit of account discussion when those easements are determined to be intangible assets and not leases.



Excerpt from ASC 350-30

> Example 11: Trade Name

55-33 This Example illustrates the guidance in paragraphs 350-30-35-21 through 35-24.

55-34 Entity B purchases an international vacuum cleaner manufacturer, Entity A, which sells vacuums under a well-known trade name. The operations of Entity A are conducted through separate legal entities in three countries and each of those legal entities owns the registered trade name used in that country. When the business combination was recorded, Entity B recorded three separate intangible trade name assets because separate financial statements are required to be prepared for each separate legal entity. There are separate identifiable cash flows for each country, and each country represents an asset group under the Impairment or Disposal of Long-Lived Assets Subsections of Subtopic 360-10. A single brand manager is responsible for the Entity A trade name, the value of which is expected to be recovered from the worldwide sales of Entity A's products.

55-35 Based on an evaluation of the circumstances, three separately recorded trade name assets would be combined into a single unit of accounting for purposes of testing the acquired trade name for impairment. The three registered trade names were acquired in the same business combination and, absent the requirement to prepare separate financial statements for subsidiaries, would have been recorded as a single asset. The trade name is

managed by a single brand manager. If sold, Entity C would most likely sell all three legally registered trade names as a single asset.



Example 3.2.20

Consolidated vs stand-alone financial statements

Expanding Example 11 in Subtopic 350-30, the three subsidiaries (each holding one of the trade names) are Sub 1, Sub 2 and Sub 3.

Sales associated with the trade names in Sub 1 and Sub 2 have increased over the past several years and are projected to increase in the future. Sales associated with the trade name in Sub 3 have been in decline and are not anticipated to recover in the near term. In the current period, the results of impairment testing for the trade names are as follows.

	Sub 1	Sub 2	Sub 3	Consolidated
Fair value	100	125	40	265
Carrying amount	60	55	60	175
Difference	40	70	(20)	90
Impairment?	No	No	Yes	No

Because the fair value of the unit of account (consisting of the three trade names) in consolidation exceeds the combined carrying amount, no impairment loss is recognized in the consolidated financial statements.

However, in its stand-alone financial statements, Sub 3 recognizes an impairment loss of \$20 – the difference between the fair value and carrying amount of the individual trade name (see [chapter 7](#)).



Excerpt from ASC 350-30

> Example 12: Brands

55-36 This Example illustrates the guidance in paragraphs 350-30-35-21 through 35-24.

55-37 Entity Z manufactures and distributes cereals under two different brands, Brand A and Brand B. Both brands were acquired in the same business combination. Entity Z recorded two separate intangible assets representing Brand A and Brand B. Each brand represents a group of complementary indefinite-lived intangible assets including the trademark, the trade dress, and a recipe. Brand A has two underlying trade names for its Honey and Cinnamon cereals. The trade name and recipe of Cinnamon were internally generated subsequent to the acquisition of Brand A. Sales of Honey have decreased while sales of Cinnamon have increased over the past several years. Despite the decline in sales of Honey, the combined sales of Honey and Cinnamon have increased at the levels expected by management. Sales of Brand B also

have increased at expected levels. There are discrete cash flows for Honey, Cinnamon, and Brand B, and each represents a separate asset group under the Impairment or Disposal of Long-Lived Assets Subsections of Subtopic 360-10. Both Honey and Cinnamon are managed by one brand manager. A separate brand manager is responsible for Brand B; however, there are some shared resources used by these groups, such as procurement. While Entity Z has no current plans to sell its brands or exit the cereal business, it believes if it ever did, it would exit the cereal business in its entirety.

55-38 Based on an evaluation of the circumstances, Entity Z would have two units of accounting for purposes of testing the acquired brands for impairment. Brand A's purchased Honey and internally generated Cinnamon trademarks should be combined as a single unit of accounting for purposes of impairment testing. The intangible asset associated with the Cinnamon trademark is simply a variation of the previously acquired Brand A Honey trademark. Although they are associated with different asset groups, they are managed by a single brand manager. Entity Z would consider Brand B to be a separate unit of accounting for purposes of testing impairment because that brand is managed separately from Brand A and is used exclusively by a separate asset group under the Impairment or Disposal of Long-Lived Assets Subsections of Subtopic 360-10.

3.2.40 Restrictions in combining intangible assets



Question 3.2.60

Can the unit of account for testing indefinite-lived assets for impairment also include finite-lived intangible assets?

Interpretive response: No. The unit of account used for testing indefinite-lived intangible assets can contain only indefinite-lived intangible assets. [350-30-35-26(a)]

The model for testing indefinite-lived intangible assets differs from the models used for testing long-lived assets (see [section 3.3](#)) and goodwill (see [section 3.4](#)). In both of those models, the unit of account subject to testing typically includes a variety of assets instead of being restricted to the specific asset(s) being tested. [360-10-35-27]



Question 3.2.70

Can a unit of account comprise the entire business?

Interpretive response: No. If a business (or nonprofit activity) comprises two or more indefinite-lived intangible assets, those assets cannot be identified as a single unit of account. Such designation is specifically prohibited by Subtopic

350-30 and therefore overrides any determination based on the general factors to be considered (see [Question 3.2.10](#)). [350-30-35-26(b)]

If the prohibition applies, an entity will need to identify at least two units of account even if the indicators for grouping the assets are otherwise present.



Question 3.2.80

How is the 'different asset groups' indicator applied?

Interpretive response: An asset group is the unit of account for testing long-lived assets for impairment (see [section 3.3](#)). The 'different asset groups' indicator (Indicator H in [Question 3.2.10](#)) is one of the factors that rebuts combining indefinite-lived intangible assets. However, the FASB examples in Subtopic 350-30 highlight when other indicators may overcome that indicator.

Example 10 in Subtopic 350-30

The easements in the Northern pipeline in Example 10 are combined into a single unit of account. This is not simply because the easements are in the same asset group, but also because other relevant indicators suggest they should be combined.

- If acquired in a single transaction, the easements would have been recorded as one asset (Indicator B).
- If sold, the easements would likely be sold as a group with the related pipeline (Indicator C).

Similarly, the easements in the Southern pipeline are treated as a single unit of account.

However, the Northern easements and Southern easements are treated as separate units of account because they are not in the same asset group, they generate independent cash flows (Indicator E), and there are no indicators suggesting combination.

Example 11 in Subtopic 350-30

In contrast to Example 10, the trade names in Example 11 are combined into a single unit of account even though they are in separate asset groups. This is because other indicators suggest combination.

- The country-registered trade names are part of the same overall trade name used by the group and are managed by a single brand manager (Indicator D; see [Question 3.2.30](#)).
- If it hadn't been for the legal requirement to prepare stand-alone financial statements for each subsidiary holding a trade name, the trade names would have been recorded as one asset in the acquisition accounting (Indicator B).
- If sold, the trade names would likely be sold as a single asset (Indicator C).

Example 12 in Subtopic 350-30

Like Example 11, the two cereal trademarks in Example 12 are in separate asset groups. However, the two trademarks are part of a single brand (Brand A) in the marketplace and are managed together (Indicator D); therefore, they are combined into a single unit of account. In contrast, Brand B is not combined with Brand A because, in addition to being in a separate asset group, it is managed separately from Brand A.

3.3 Long-lived assets: asset group

3.3.10 Overview



Excerpt from ASC 360-10

20 Glossary

Asset Group

An asset group is the unit of accounting for a long-lived asset or assets to be held and used, which represents the lowest level for which identifiable cash flows are largely independent of the cash flows of other groups of assets and liabilities.

- > Grouping Long-Lived Assets Classified as Held and Used

35-23 For purposes of recognition and measurement of an impairment loss, a long-lived asset or assets shall be grouped with other assets and liabilities at the lowest level for which identifiable cash flows are largely independent of the cash flows of other assets and liabilities. However, an impairment loss, if any, that results from applying this Subtopic shall reduce only the carrying amount of a long-lived asset or assets of the group in accordance with paragraph 360-10-35-28.

- • > Effect of Goodwill when Grouping

35-26 Goodwill shall be included in an asset group to be tested for impairment under this Subtopic only if the asset group is or includes a reporting unit. Goodwill shall not be included in a lower-level asset group that includes only part of a reporting unit. Estimates of future cash flows used to test that lower-level asset group for recoverability shall not be adjusted for the effect of excluding goodwill from the group. The term reporting unit is defined in Topic 350 as the same level as or one level below an **operating segment**. That Topic requires that goodwill be tested for impairment at the reporting unit level.

The assets making up the category of long-lived assets are discussed in [section 2.4](#), but key examples include PP&E, right-of-use assets (following adoption of the new leases standard, Topic 842) and finite-lived intangible assets. Long-lived assets have two further classifications.

- **Assets held-for-sale.** Long-lived assets to be disposed of are classified as held-for-sale if they meet a series of specific criteria. If the criteria are met, the asset (or disposal group) is measured at the lower of its carrying amount and fair value less cost to sell. The held-for-sale criteria and related accounting requirements are discussed in chapter 4 of KPMG Handbook, [Discontinued operations and held-for-sale disposal groups](#). These assets are outside the scope of this Handbook.
- **Assets held-and-used.** Other long-lived assets are tested for impairment in asset groups, and there is only one criterion for determining the appropriate groupings. Specifically, long-lived assets are grouped with other assets and liabilities at the lowest level for which identifiable cash flows are largely independent of the cash flows of other assets and liabilities. Applying this criterion to determine the composition of a long-lived asset group requires significant judgment based on the specific facts and circumstances. [360-10-35-23]

3.3.20 Asset group vs reporting unit

 **Question 3.3.10**
What is the difference between an asset group and a reporting unit?

Background: An asset group is the unit of account for testing long-lived assets for impairment. In contrast, a reporting unit is the unit of account for testing goodwill for impairment (see [section 3.4](#)).

Interpretive response: The following diagram shows a typical relationship between an asset group and a reporting unit.

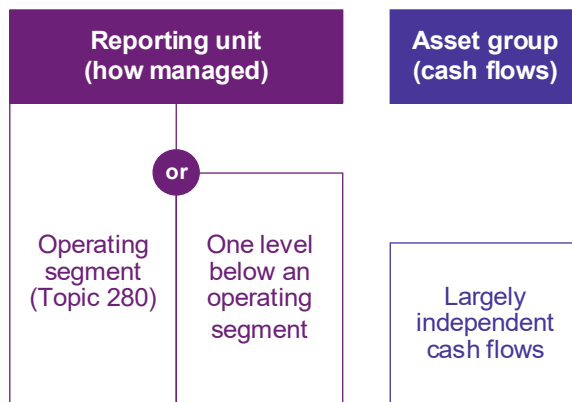

The key difference is that the reporting unit is based on how the business is managed, which is aligned with the definitions used in Topic 280 (segment reporting). A reporting unit is an operating segment or one level below an operating segment, and it must constitute a business for which discrete

financial information is available and the operating results are regularly reviewed by segment management. For a discussion of reporting units, see [section 3.4](#).

An asset group is based on the extent to which the cash flows (inflows and outflows) are independent – it is not relevant how those assets are managed. This means that an asset group will often be at a level lower than a reporting unit, as illustrated in the diagram. However, the asset group can be at the same level as a reporting unit in certain circumstances. [\[360-10 Glossary\]](#)

In the size relationship depicted in the illustration, whereby only a portion of a reporting unit is included in the asset group, no goodwill is included in the asset group for impairment testing. However, if the asset group is or includes a reporting unit, the associated goodwill of the reporting unit is included in the asset group for impairment testing. [\[360-10-35-26, 350-20-35-34\]](#)

3.3.30 Determining the asset group



Question 3.3.20

How does an entity determine asset groups?

Interpretive response: To determine an asset group, an entity starts with the lowest level at which it tracks financial operating information related to a group of long-lived assets and considers whether that asset group is capable of generating cash flows largely independent of other asset groups.

Several approaches have developed in practice to provide a framework to evaluate whether a group of assets and liabilities has independent, identifiable cash flows, including (1) revenue dependency and (2) shared costs. While both approaches contain important considerations, we generally look to whether there are significant interdependencies in revenue-producing activities first. This is because operating activities (shared costs) of the entity are more likely to be allocated and therefore may not provide a clear view of the independence of cash flows.

Revenue dependency approach

The revenue dependency approach focuses on the degree to which the asset group's revenues depend on the revenue-producing activities of one or more other asset groups and therefore support grouping at a higher level.

Generally, revenue dependency exists when an asset group's revenue depends on:

- the operating presence of other asset groups in the same geographic area; or
- the asset group's ability to offer the products or services of another asset group.

If these or similar relationships among asset groups limit an entity's ability to dispose of an asset group without undermining the revenue-producing ability of

another group(s), a higher-level grouping may be justified. This approach is discussed further in [Questions 3.3.30 to 3.3.60](#).

Shared costs approach

The shared costs approach focuses on the degree to which an asset group's total cash flows (inflows and outflows) depend on the activities of one or more other asset groups. Specifically, if the cash flows of an asset group result from significant shared operating activities, an asset grouping at a higher level may be justified. We believe that an asset group's shared operating activities are significant when the sum of the group's shared cash outflows exceeds 50% of the group's total cash outflows. This approach is discussed further in [Questions 3.3.70 and 3.3.80](#).



Question 3.3.30

How are asset groups determined when contractual limitations create revenue dependency?

Interpretive response: In applying the revenue dependency approach (see [Question 3.3.20](#)), asset groups may have interdependent revenues because of limitations imposed by contracts with unrelated entities. Contractual limitations that create revenue dependency may cause the asset group to be determined at a higher level than would otherwise be the case.

Example 4 in Topic 360 describes a situation in which the contractual requirement to continue to operate five bus routes – including one at a significant loss – requires the entity to group the dedicated long-lived assets for all five routes as one asset group. Although the cash flows could be determined at a lower level (i.e. per bus route), the entity does not have the ability under the contract to curtail any one route. Therefore, the cash flows for each route are largely interdependent. [\[360-10-55-36\]](#)



Excerpt from ASC 360-10

- > Example 4: Grouping Assets for Impairment Review

55-35 Varying facts and circumstances will inevitably justify different groupings of assets for impairment review. While grouping at the lowest level for which there are identifiable cash flows for recognition and measurement of an impairment loss is understood, determining that lowest level requires considerable judgment.

55-36 This Example illustrates the need for judgment in grouping assets for impairment, as discussed in paragraphs 360-10-35-23 through 35-25. In this Example, an entity operates a bus entity that provides service under contract with a municipality that requires minimum service on each of five separate routes. Assets devoted to serving each route and the cash flows from each route are discrete. One of the routes operates at a significant deficit that results in the inability to recover the carrying amounts of the dedicated assets.

The five bus routes would be an appropriate level at which to group assets to test for and measure impairment because the entity does not have the option to curtail any one bus route.



Question 3.3.40

How are asset groups determined by a retailer that has some unprofitable stores?

Interpretive response: Determining asset groups follows the general guidance in [Questions 3.3.20 to 3.3.50](#) regardless of the profitability of stores. As such, determining whether a population of profitable and unprofitable stores is an asset group depends on the specific situation. Varying facts and circumstances will inevitably justify different groupings of assets and determining the lowest level of identifiable independent cash flows requires considerable judgment.

[Example 3.3.10](#) illustrates one set of circumstances in which it is appropriate to group a collection of stores as a single asset group – based on market conditions and the historical analysis of the stores, and not simply on either management’s intent at a point in time or the profitability of any individual store.

For a discussion of flagship stores, see [Question 3.3.100](#).



Example 3.3.10

Determining asset groups when some operations are unprofitable

ABC Corp. operates 50 pharmacies in 15 geographic areas and can identify cash flows at the individual store level.

One of the areas comprises four stores clustered in a 10-mile radius. When ABC considers whether each individual store is capable of generating cash flows largely independent of other stores, it notes that customers regularly shop at each of the four stores in that area and do not limit their purchases to any specific store. Three of the stores are profitable, but the fourth store has been unprofitable for years.

ABC believes that selling or closing the unprofitable store would make the area attractive to competition, and revenues would then decline in the three other stores. For that reason, ABC has continued operating the unprofitable store even though it now expects the store to remain unprofitable for the foreseeable future. Further, ABC has no history of selling or closing individual unprofitable stores that are part of a market cluster and does not believe that a buyer of its stores would acquire an individual store; a market participant would be expected to acquire only the cluster of stores.

On the basis of its specific fact pattern, ABC concludes that the four stores should be combined into a single asset group.



Question 3.3.50
Can assets be grouped at a higher level when different operational assets are interchangeable?

Interpretive response: When an entity’s key operational assets are interchangeable, identifying the level at which cash flows are largely independent is more difficult. For example, in our experience, there are two industries in which this issue is prevalent, but the same issue may arise in other industries and/or circumstances.

Airline industry

AICPA Audit and Accounting Guide, Airlines, includes specific guidance on determining asset groups. It concludes that the cash flows of cargo airlines are typically assessed at the network level due to the significant integration of short-haul and long-haul cargo operations. It also notes the impracticability of evaluating individual aircraft for their ability to generate independent cash flows because of their interchangeability in an airline’s operations.



Excerpt from AAG-AIR

4.57 Identifying the group of assets at which cash flows are largely independent requires judgment; however, most passenger airlines have concluded that each aircraft type (and potentially each aircraft model) provides largely independent cash flows. When making the determination of how to group aircraft and related fleet assets (that is, rotatable parts, leasehold improvements, and expendable parts that are used by a particular fleet and are considered part of the asset group; see the “Related Fleet Assets” section of this chapter for further discussion) for impairment testing, airlines consider whether a particular fleet depends on another fleet for connecting traffic (for example, a short haul flight feeds traffic to longer haul connecting flights) and whether it is necessary to combine those fleets for impairment testing. Although cash flows for specific aircraft may be obtainable, it is generally not practical to evaluate cash flows at this level due to the interchangeability of aircraft in an airline’s operations, unless the aircraft is not interchangeable with other aircraft in the airline’s fleet. Cargo airlines cash flows are typically assessed at the network level due to the significant integration of the short haul and long haul cargo operations. Regional carriers’ cash flows may be assessed at a contract level as the regional carrier’s contract with the major airline may be the lowest level of identifiable cash flows.

Shipping industry

We believe the guidance for asset grouping for the airline industry generally applies to the shipping industry.

Like aircraft in a fleet, a container vessel is often interchangeable with a shipping company’s fleet of such vessels. If a vessel is put out of service, another vessel is placed in service to meet customers’ shipping requirements. Further, container vessels can be analogized to a cargo airline’s short-haul and

long-haul operations, whereby the containers are shipped regionally and then transferred to other vessels for global shipping.

Therefore, when networks are integrated, it is appropriate to combine the vessels at the network level to evaluate cash flows instead of evaluating cash flows for the individual vessels. The following are exceptions.

- If a vessel or group of vessels is not interchangeable with other vessels in the fleet, it may be its own asset group – i.e. it would be appropriate to assess the cash flows of the specific vessel or group of vessels.
- If an entity provides only regional shipping, consideration should be given to whether the lowest level of identifiable cash flows is at a contract level.



Question 3.3.60

Can assets be grouped at a higher level when output can be shifted between production facilities?

Interpretive response: It depends. In applying the revenue dependency approach (see [Question 3.3.20](#)), we believe an entity generally should consider the revenues generated from an individual asset group to be the ‘direct’ cash flows for that asset group. Whether an entity’s ability to shift revenue among asset groups with otherwise identifiable cash flows justifies a higher-level asset grouping requires careful consideration.

For example, many manufacturing companies have plants with some element of redundant capacity or ability to shift production. Just because management has the theoretical ability to reorganize and allocate production between different plants does not automatically justify grouping the plants as one asset group. However, there may be some scenarios in which a higher-level grouping may be appropriate. For example, if management has a track record and a continued expectation of evaluating and making decisions about production for a group of related facilities and reallocating production or assets between those facilities, this may be a basis for grouping assets at a higher level.



Question 3.3.70

How are asset groups determined when costs are shared across operations vs direct costs allocated simply for administrative convenience?

Background: Shared costs are those costs the entity incurs for operating activities that support all or part of its business and that cannot be directly associated with any of the individual asset groups.

In contrast, allocated direct costs are those costs that are directly associated with an individual asset group, but as an administrative convenience are recorded at the corporate, divisional or regional headquarters level. Frequently, allocated direct costs will relate to a specific asset or asset group even though

the entity does not allocate the costs on that basis for internal reporting and/or income tax purposes.

Interpretive response: If specific identification is possible, we believe an entity should allocate direct costs to the related asset when evaluating the cash flows of that asset (or group of assets). Judgment is required to evaluate costs and determine whether they are shared costs or direct costs in the grouping analysis.

For example, an entity might receive a master bill for its energy costs that is recorded as an expense at corporate headquarters.

- If the costs are based on usage and the entity has access to information such as usage statistics to serve as a basis for allocating the cost to each of the entity's locations, those costs should be allocated to the locations as direct costs.
- In contrast, if the costs are based on a corporate-wide rate structure that does not depend on the number of locations or usage, the entity might not have a basis to assign those costs to individual locations. In that case, it might be appropriate for the entity to consider those costs as shared costs.

However, as noted in [Question 3.3.20](#), grouping assets based on shared operating activities requires significant shared cash outflows. Therefore, for most entities shared costs will not be determinative on their own.



Question 3.3.80

How are asset groups determined when shared costs are unrelated to operations?

Interpretive response: Shared costs that are unrelated to operations should not influence the level at which asset groups are determined. Therefore, an important factor in determining whether an asset group has cash flows that are largely independent of the cash flows of other asset groups is the extent to which shared services relate to the operations of the assets under evaluation – e.g. procurement, sales, marketing, research and development.

An entity should evaluate all costs related to significant shared activities to determine the nature of those activities and whether they actually relate to the operations of the specific asset(s). This analysis may indicate that certain shared costs do not justify a higher grouping, as illustrated in the following examples.

- **Shared financing.** Such activity does not in itself justify a higher grouping because an impairment analysis does not depend on the method or means used to finance the asset groups. The valuation of an asset (which is the basis for impairment testing) is independent of the method used to finance the asset (see [Question 5.3.30](#)).
- **Shared back-office support.** Such activity (e.g. shared data center) does not in itself justify a higher asset grouping because an entity can usually obtain back-office support for the lower-level asset group easily from other sources or develop that support internally.

3.3.40 Enterprise assets



Excerpt from ASC 360-10

- > Grouping Long-Lived Assets Classified as Held and Used

35-24 In limited circumstances, a long-lived asset (for example, a corporate headquarters facility) may not have identifiable cash flows that are largely independent of the cash flows of other assets and liabilities and of other asset groups. In those circumstances, the asset group for that long-lived asset shall include all assets and liabilities of the entity.

35-25 In limited circumstances, an asset group will include all assets and liabilities of the entity. For example, the cost of operating assets such as corporate headquarters or centralized research facilities may be funded by revenue-producing activities at lower levels of the entity. Accordingly, in limited circumstances, the lowest level of identifiable cash flows that are largely independent of other asset groups may be the entity level. See Example 4 (paragraph 360-10-55-35).

An enterprise asset is a term used in practice to describe an asset that supports the revenue-producing activities of two or more asset groups. It might also be called a corporate-support asset. An example of an enterprise asset is a trade name that supports the revenue generated by various product groups.



Question 3.3.90

How is the unit of account for an enterprise asset determined?

Background: Paragraphs 360-10-35-24 and 35-25 refer to a higher-level asset (e.g. centralized research facilities) causing the asset group to be *all* assets and liabilities of the entity – i.e. the enterprise asset is at the entity level. However, the concept also applies at lower levels of the entity – e.g. centralized research facilities that support some (but not all) of the entity’s other operations.

Interpretive response: Topic 360 does not allow an asset that supports more than one asset group to have its carrying amount allocated among those asset groups. Instead, the unit of account for testing impairment of an enterprise asset comprises that asset plus the other assets and liabilities that together capture the lowest level for which identifiable cash flows are largely independent of the cash flows of other assets and liabilities. This unit of account for impairment testing is in addition to the lower-level asset groups that exclude the enterprise asset. [360-10-35-24 – 35-25]

To illustrate, in the following diagram there are two enterprise assets, each related to a different part of the entity’s business.

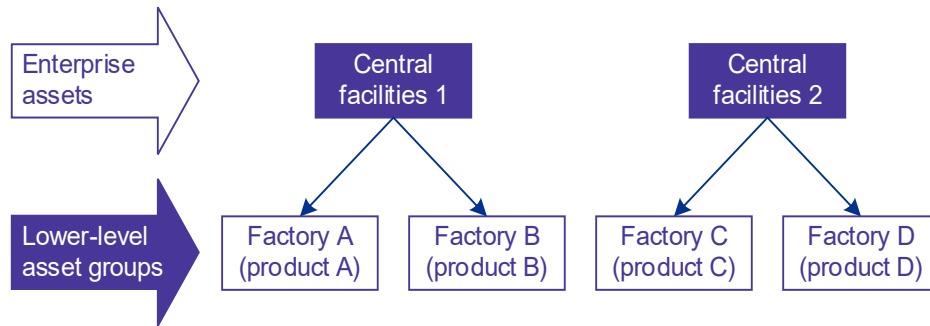

In this example, there are six units of account (asset groups):

- Each of factories A, B, C and D
- Central facilities 1 plus factories A and B
- Central facilities 2 plus factories C and D.

For a discussion about how the impairment test is applied to enterprise assets, including the order of testing and applying the appropriate level of cash flows, see [Question 7.7.10](#).

Note: This accounting for enterprise assets differs from the goodwill impairment model under Subtopic 350-20. Under that model, assets or liabilities that relate to or that benefit the operations of multiple reporting units are allocated among the reporting units in a reasonable, supportable and consistent manner (see [Question 5.4.40](#)).



Example 3.3.20 Identifying enterprise assets

ABC Corp. operates wholesale distribution and retail facilities throughout the country. ABC operates under licenses granted by the individual states in which its distribution and retail facilities are located. The licenses are identified as enterprise assets that support both ABC's wholesale and retail sales businesses.

ABC's products are sourced from third-party manufacturers overseas. Sales are made through the retail network to consumers and through the wholesale distribution channels to commercial customers.

ABC has experienced a decline in sales that it attributes to current economic conditions. As a result, it plans to test both the wholesale and retail asset groups for impairment. Further, ABC will test the licenses for impairment because the trigger for impairment testing (declining sales, see [section 4.3.10](#)) affects the licenses as well as the tangible assets.

Therefore, ABC identifies three units of account:

- Wholesale network
- Retail network
- Licenses plus the wholesale and retail networks.

Enterprise asset is an indefinite-lived intangible asset

Assume the same facts except that the enterprise asset is an indefinite-lived intangible asset, such as a tradename. In that case, the tradename would be its own unit of account and the impairment test would be performed at that level (see [section 3.2](#)).



Question 3.3.100

Can a retailer's flagship store be considered an enterprise asset?

Background: A retailer may open a flagship store, which is a store located in a prominent location (such as a tourist destination) that is used to showcase the retailer's products. These stores are frequently different from the retailer's other stores, both in terms of size, decor, product offerings and service.

In our experience, retailers typically determine the individual store as the lowest level for which identifiable cash flows are largely independent of the cash flows of other assets and liabilities.

Interpretive response: A flagship store may be considered an enterprise asset when it supports the revenue-producing activities of lower-level asset groups consisting of the other stores.

We believe the following may be indicators that a flagship store is an enterprise asset.

- The primary business purpose for opening the store was brand awareness.
- The retailer anticipated negative cash flows when the store was opened.
- The retailer expects to have aggregate negative cash flows for the store over the life of the store's underlying assets.
- The size of the store, capital expenditures to build out the store and its operating costs are significantly in excess of the retailer's other stores.
- A significant amount of returns from flagship store purchases are made at the retailer's other stores.

If a retailer determines that a flagship store is an enterprise asset (e.g. for other stores in a city or region), multiple units of account are identified as discussed in [Question 3.3.90](#).

3.3.50 Revising asset groups

An entity should reassess its asset grouping if it experiences a significant change in facts and circumstances.



Question 3.3.110

When are asset groups revised, and how is a change accounted for?

Interpretive response: Changes in facts and circumstances that may warrant reassessing asset groups include changes:

- in operating structure;
- in the way the entity deploys long-lived assets – other than routine changes in management; and
- in the manner in which the entity expects to recover the asset.

Question 6.5.60 of KPMG Handbook, [Leases](#), discusses the potential reassessment of asset groups when an entity plans to significantly change how it uses a right-of-use asset that is part of a larger asset group.

Changes in asset groups that result from changes in facts and circumstances are changes in estimates under Topic 250. Therefore, the change is accounted for prospectively and previously issued financial statements are not revisited. An entity should disclose a change in grouping and the circumstances of the change (see [Question 10.3.10](#)). For a more in-depth discussion of changes in estimates, see section 3.4 of KPMG Handbook, [Accounting changes and error corrections](#). [250-10-45-17]

Further, an entity should carefully consider whether the event or circumstances that result in a change in asset groups also indicates a potential impairment of one or more of the changed asset groups. For example, an *adverse* change in the way the entity deploys a long-lived asset may be a triggering event for both an asset group change and possible impairment. For a discussion of events that may trigger impairment testing, see [section 4.3](#).



Example 3.3.30

Impact of a change in asset grouping

ABC Corp. owns and operates six store locations within a 10-mile radius. Each store location sells clothing, home goods and groceries, and four of the locations generate a profit.

During Year 1, ABC demonstrates revenue dependency among the six locations and combines them into a single asset group for impairment testing purposes.

Note: This example assumes that ABC’s facts and circumstances supported this conclusion; see [Question 3.3.40](#) and [Example 3.3.10](#).

In Year 2, ABC conducts an overhaul of its strategy and branding. This results in each store focusing on clothing, home goods *or* groceries. Unique branding is also given to each new store type. Under this new model, ABC now operates two clothing stores, two home goods stores and two grocery stores.

Based on the change in structure and the way the stores are now operated, ABC concludes that the revenues of the six stores are no longer interdependent, including those that are similarly branded (e.g. clothing, home goods and grocery). Instead, ABC concludes that each individual store is now a

separate unit of account because this is the lowest level for which identifiable cash flows are largely independent of the cash flows of the other stores.

ABC accounts for the change prospectively as a change in estimate; its previously issued financial statements are not revised. Further, ABC assesses whether the impact of the new operating and branding model is a triggering event that requires immediate impairment testing to be carried out (see [section 4.3](#)).



Question 3.3.120

Does the sale of part of an asset group indicate that asset groups should be identified at a lower level?

Interpretive response: Not necessarily. We believe that the answer depends on whether the portion of the asset group sold had discrete, identifiable cash flows on a stand-alone basis.

For example, the sale of a commercial refrigerator or other similar equipment by the operator of a quick-service restaurant does not call into question whether the operator's restaurant asset groups are at an appropriately low level. The sold asset did not have discrete cash flows and therefore could not have been a separate asset group.

In a different example, an entity owns and operates several quick-service restaurants, and each restaurant location has identifiable cash flows. The entity previously concluded that all the restaurants in a geographic territory represented an asset group because of revenue interdependency (see [Question 3.3.20](#)). If the entity later sells or closes fewer than all the restaurants within that territory in an individual transaction, it may indicate that cash flows are largely independent at a lower level than the territory originally determined.



Question 3.3.130

Does the potential sale of part of a retail group result in a change in asset groups?

Background: A retailer that considers each individual store to be a separate asset group is considering the sale of a group of stores in the future. Long-lived assets to be disposed of are classified as held-for-sale if they meet a series of specific criteria. If the criteria are met, the asset (or disposal group) is measured at the lower of its carrying amount and fair value less cost to sell. The held-for-sale criteria and related accounting requirements are discussed in chapter 4 of KPMG Handbook, [Discontinued operations and held-for-sale disposal groups](#). Unless and until these criteria are met, the assets continue to be classified as held-and-used.

Interpretive response: It depends. For retail assets classified as held-and-used, the lowest level of identifiable, largely independent cash flows is generally the individual store. However, by definition, asset groups comprise assets that are used together to generate joint cash flows (see [Question 3.3.20](#)). Further, the

cash flows used to test for impairment are the cash flows that correspond to the asset's use and eventual disposition (see [section 7.2](#)).

If management intends to sell certain stores as a group in a single transaction or series of linked transactions, we believe they can be reclassified as a single asset group if:

- management's intent is clear notwithstanding that the held-for-sale criteria are not yet met; and
- there is reasonable assurance that the stores could only be sold as a group. This assumes that a typical buyer (market participant) would demand to buy the stores as a group.

If a change in grouping from the individual store to the combined group level is deemed appropriate, the entity should carefully consider whether there is an indicator of impairment that would require impairment testing (see [Question 4.3.120](#)). Further, the financial statements should disclose the retailer's policy for grouping assets that it expects to be disposed of as a group.



Question 3.3.140

Does the potential forfeiture of part of an asset group affect the remaining part of the group?

Interpretive response: It depends. If management intends to forfeit part of an asset group to settle an obligation, we believe those assets should be reclassified as a single asset group if there is reasonable assurance that the forfeiture will proceed.

This is on the basis that these assets are intended to be used together to generate joint cash flows (see [Question 3.3.20](#)), and the cash flows used to test for impairment correspond to the assets' planned use and eventual disposition (see [section 7.2](#)).

If a change in asset groups is deemed appropriate, the financial statements should include appropriate disclosure (see [Question 10.3.10](#)).

3.4 Goodwill: Reporting unit

The guidance in this section does not apply to entities that elect the private company and NFP alternative for goodwill impairment (see [chapter 11](#)).

3.4.10 Overview



Excerpt from ASC 350-20

> Overall Accounting for Goodwill

35-1 Goodwill shall not be amortized. Instead, goodwill shall be tested for impairment at a level of reporting referred to as a **reporting unit**.

> Reporting Unit

35-33 The provisions of Topic 280 shall be used to determine the **reporting units** of an entity.

35-34 A component of an **operating segment** is a reporting unit if the component constitutes a business or a **nonprofit activity** for which discrete financial information is available and segment management, as that term is defined in paragraph 280-10-50-7, regularly reviews the operating results of that component. Subtopic 805-10 includes guidance on determining whether an asset group constitutes a business. Throughout the remainder of this Section, the term *business* also includes a *nonprofit activity*.

35-35 However, two or more components of an operating segment shall be aggregated and deemed a single reporting unit if the components have similar economic characteristics. Paragraph 280-10-50-11 shall be considered in determining if the components of an operating segment have similar economic characteristics.

35-36 An operating segment shall be deemed to be a reporting unit if all of its components are similar, if none of its components is a reporting unit, or if it comprises only a single component.

35-37 Reporting units will vary depending on the level at which performance of the segment is reviewed, how many businesses the operating segment includes, and the similarity of those businesses. In other words, a reporting unit could be the same as an operating segment, which could be the same as a reportable segment, which could be the same as the entity as a whole (entity level).

35-38 An entity that is not required to report segment information in accordance with Topic 280 is nonetheless required to test goodwill for impairment at the reporting unit level. That entity shall use the guidance in paragraphs 280-10-50-1 through 50-9 to determine its operating segments for purposes of determining its reporting units.

> Implementation Guidance

55-1 Determining whether a component of an **operating segment** is a **reporting unit** is a matter of judgment based on an entity's individual facts and circumstances. Although paragraphs 350-20-35-33 through 35-35 includes a number of characteristics that must be present for a component of an operating segment to be a reporting unit, no single factor or characteristic is determinative. How an entity manages its operations and how an acquired entity is integrated with the acquiring entity are key to determining the reporting units of the entity.

55-2 The characteristics identified in paragraphs 350-20-35-33 through 35-35 that must be present for a component to be a reporting unit are discussed in the following implementation guidance.

- > The Component Constitutes a Business or a Nonprofit Activity

55-3 The determination of whether a component constitutes a **business** or a **nonprofit activity** requires judgment based on specific facts and circumstances. The guidance in Section 805-10-55 should be considered in

determining whether a group of assets constitutes a business or a nonprofit activity.

Goodwill is subject to impairment testing at the reporting unit level. The reporting unit is the level of internal reporting that reflects the way in which an entity manages its business or operations and to which goodwill would naturally be associated. As illustrated in the diagram, a reporting unit is either an operating segment or a component of an operating segment, depending on a series of criteria. [350-20-35-34, 35-36]

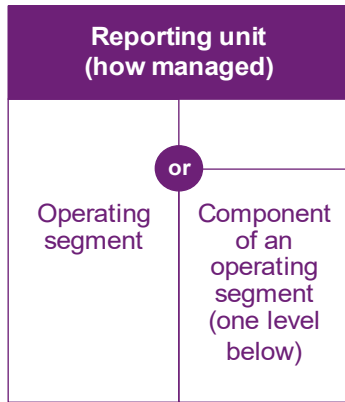

The identification of operating segments is discussed in chapter 4 of KPMG Handbook, [Segment reporting](#), and is not repeated here. Instead, this section focuses on determining whether reporting units should be identified at a level lower than the operating segment.

 **Question 3.4.10**
What are the building blocks for determining reporting units?

Interpretive response: The building blocks for determining an entity’s reporting units are its operating segments and the components thereof. As shown in the following table, the guidance for identifying those building blocks is drawn mainly from Topic 280.

Applicable guidance	
Operating segment	
A component of an entity: <ul style="list-style-type: none"> — that engages in business activities from which it <i>may</i> earn revenue; — whose operating results are regularly reviewed by the CODM; and — for which discrete financial information is available. 	Apply Topic 280. [280-10-50-1] See chapter 4 of KPMG Handbook, Segment reporting .

Applicable guidance	
A component of an operating segment is a reporting unit when:	
Criterion 1. It is a 'business' for which 'discrete financial information' is available. See section 3.4.20 .	Apply the definition of a business in Topic 805, and the guidance on discrete financial information in Topic 280. [280-10-55-3 – 55-4]
Criterion 2. Its operating results are reviewed regularly by 'segment management'. See section 3.4.30 .	Apply the guidance on segment management in Topic 280. [350-20-35-34]
Criterion 3. Its 'economic characteristics' are different from the economic characteristics of the other components of the operating segment. See section 3.4.40 .	Apply the guidance on similar economic characteristics in Topic 280, which supplements the specific guidance in Subtopic 350-20. [350-20-35-35]

A component of an operating segment is not necessarily the same as a 'component of an entity', which is a defined term used in presenting discontinued operations; see chapter 3 of KPMG Handbook, [Discontinued operations and held-for-sale disposal groups](#).

If an operating segment has no components, then the operating segment itself is the reporting unit. [350-20-35-36]

 **Question 3.4.20**
Does an entity that does not provide segment disclosures have to identify operating segments?

Background: Only public entities are required to provide segment disclosures under Topic 280. Other entities are encouraged, but not required, to provide these disclosures. However, if other entities voluntarily provide segment disclosures, they are required to fully comply with Topic 280 and include the required segment disclosures for all periods presented. [280-10-15-2]

Interpretive response: Yes. An entity that does not report segment information under Topic 280 is nonetheless required to test goodwill for impairment at the reporting unit level. Therefore, in determining reporting units, all entities – other than those applying the goodwill amortization accounting alternative (see [chapter 11](#)) – apply the guidance in Topic 280 to identify operating segments and components thereof. [350-20-35-38]



Question 3.4.30 What is the relationship between operating segments, reportable segments and reporting units?

Interpretive response: In determining an entity's reporting units, the term 'operating segment' refers to the units identified before any aggregation under Topic 280 – i.e. entities should not aggregate operating segments before identifying their reporting units.

The following diagram highlights this difference between Topic 280 (determining reportable segments) and Subtopic 350-20 (determining reporting units). Both analyses begin with operating segments determined under Topic 280.

- **Segment reporting.** The aggregation criteria in Topic 280 are applied to the operating segments to determine reportable segments.
- **Goodwill impairment testing.** Following the criteria set out in [sections 3.4.20 to 3.4.40](#), components within operating segments are identified, and the aggregation criteria are then applied to these components in determining reporting units. This process can result in reporting units being at a lower level than an operating segment (reporting units (a) and (b) in the diagram) or at the same level (reporting units (c) and (d) in the diagram); however, it cannot result in a reporting unit being at a higher level than an operating segment.

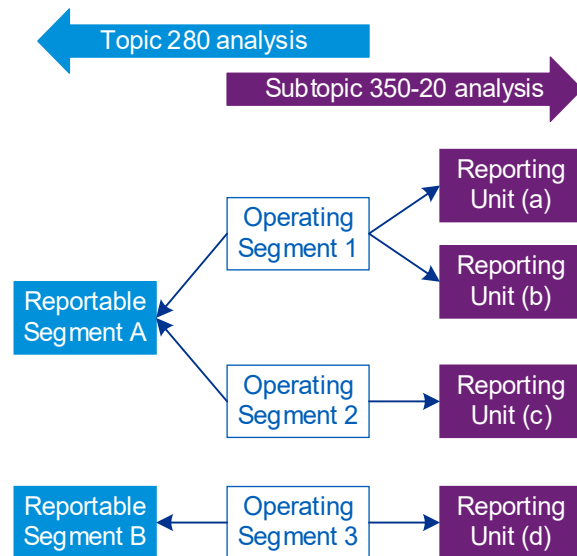



Question 3.4.40

Is an entity's legal structure relevant in determining reporting units?

Interpretive response: No. The determination of reporting units is based on how a consolidated entity is managed instead of on its legal entity structure. Therefore, if a consolidated entity is not managed using its legal entity structure, a single reporting unit could contain elements of different legal entities. This situation may occur, for example, if subsidiaries are legal reporting entities solely for tax purposes.

3.4.20 Component criterion 1: A business for which discrete financial information is available



Excerpt from ASC 350-20

- > Discrete Financial Information

55-4 The term *discrete financial information* should be applied in the same manner that it is applied in determining operating segments in accordance with paragraph 280-10-50-1. That guidance indicates that it is not necessary that assets be allocated for a component to be considered an operating segment (that is, no balance sheet is required). Thus, discrete financial information can constitute as little as operating information. Therefore, in order to test **goodwill** for impairment in accordance with this Subtopic, an entity may be required to assign assets and liabilities to reporting units (consistent with the guidance in paragraphs 350-20-35-39 through 35-40).



Question 3.4.50

When is a component a business?

Interpretive response: In summary, a business is an integrated set of activities and assets that is capable of being conducted and managed for the purpose of providing a return in the form of dividends, lower costs or other economic benefits. To qualify as a business, a set of assets and activities must have at least one input and one substantive process that together significantly contribute to the ability to create outputs. [805-10-55-3A, 55-5]

For a component to be a business, it needs to meet the definition of a business on its own merits. It would not meet the definition if it does not have a substantive process without one or more other components (e.g. through sharing arrangements).

For in-depth guidance on whether a set of assets and activities is a business, see section 2 of KPMG Handbook, [Business combinations](#).



Question 3.4.60

When is discrete financial information available for a component?

Interpretive response: For a component that is a business to be a reporting unit, there needs to be discrete financial information available about the component. The term discrete financial information is interpreted for a component in the same manner as under Topic 280 for an operating segment. [\[350-20-55-4\]](#)

Consistent with the guidance in Topic 280, the discrete financial information needs to be in enough detail to allow the segment manager to assess the component's operating results. In determining whether this test is met, it is helpful to identify what financial metrics the segment manager uses to review the operating results. [\[350-20-55-4\]](#)

Further, a segment manager may have detailed information about revenue, but only minimal information about expenses, and no information about assets and liabilities. In this case, information could qualify as discrete financial information, because there is no requirement for discrete financial information to include balance sheet information. [\[350-20-55-4, 280-10-55-5 – 55-6\]](#)

If an entity concludes that the component has no balance sheet information, care should be taken to ensure that the component does indeed meet the definition of a business (see [Question 3.4.50](#)).

3.4.30 Component criterion 2: Segment management regularly reviews the operating results



Excerpt from ASC 350-20

- > Reviewed by Segment Management

55-5 Segment management, as defined in paragraphs 280-10-50-7 through 50-8, is either a level below or the same level as the chief operating decision maker. According to Topic 280, a segment manager is directly accountable to and maintains regular contact with the chief operating decision maker to discuss operating activities, financial results, forecasts, or plans for the segment. The approach used in this Subtopic to determine reporting units is similar to the one used to determine operating segments; however, this Subtopic focuses on how operating segments are managed rather than how the entity as a whole is managed; that is, reporting units should reflect the way an entity manages its operations.



Excerpt from ASC 280-10

> Operating Segments

50-5 The term *chief operating decision maker* identifies a function, not necessarily a manager with a specific title. That function is to allocate resources to and assess the performance of the segments of a public entity. Often the chief operating decision maker of a public entity is its chief executive officer or chief operating officer, but it may be a group consisting of, for example, the public entity's president, executive vice presidents, and others.

50-7 Generally, an operating segment has a segment manager who is directly accountable to and maintains regular contact with the chief operating decision maker to discuss operating activities, financial results, forecasts, or plans for the segment. The term *segment manager* identifies a function, not necessarily a manager with a specific title.

50-8 The chief operating decision maker also may be the segment manager for certain operating segments. A single manager may be the segment manager for more than one operating segment. If the characteristics in paragraphs 280-10-50-1 and 280-10-50-3 apply to more than one set of components of a public entity but there is only one set for which segment managers are held responsible, that set of components constitutes the operating segments.



Question 3.4.70

What is the difference between the CODM and a segment manager?

Interpretive response: To be identified as a reporting unit, a component needs to have its operating results regularly reviewed by a segment manager. [350-20-35-34]

The key difference between an operating segment and a component of an operating segment is the level of management review. [280-10-50-5, 50-7 – 50-8]

- For an operating segment, the CODM represents the function that both assesses an operating segment's performance and determines the resources to be allocated to the operating segment. The CODM could be a single person or a group of people.
- For a component, a segment manager has more direct day-to-day control over operations. Although it is possible for a segment manager to also be the CODM, usually a segment manager is a person or group of people directly accountable to and maintaining regular contact with the CODM.

3.4.40 Component criterion 3: Different economic characteristics



Excerpt from ASC 350-20

- > Similar Economic Characteristics

55-6 Evaluating whether two components have similar economic characteristics is a matter of judgment that depends on specific facts and circumstances. That assessment should be more qualitative than quantitative.

55-7 In determining whether the components of an operating segment have similar economic characteristics, all of the factors in paragraph 280-10-50-11 should be considered. However, every factor need not be met in order for two components to be considered economically similar. In addition, the determination of whether two components are economically similar need not be limited to consideration of the factors described in that paragraph. In determining whether components should be combined into one reporting unit based on their economic similarities, factors that should be considered in addition to those in that paragraph include but are not limited to, the following:

- a. The manner in which an entity operates its business or nonprofit activity and the nature of those operations
- b. Whether goodwill is recoverable from the separate operations of each component business (or nonprofit activity) or from two or more component businesses (or nonprofit activities) working in concert (which might be the case if the components are economically interdependent)
- c. The extent to which the component businesses (or nonprofit activities) share assets and other resources, as might be evidenced by extensive transfer pricing mechanisms
- d. Whether the components support and benefit from common research and development projects.

The fact that a component extensively shares assets and other resources with other components of the operating segment may be an indication that the component either is not a business or nonprofit activity or it may be economically similar to those other components.

55-8 Components that share similar economic characteristics but relate to different operating segments may not be combined into a single reporting unit. For example, an entity might have organized its operating segments on a geographic basis. If its three operating segments (Americas, Europe, and Asia) each have two components (A and B) that are dissimilar to each other but similar to the corresponding components in the other operating segments, the entity would not be permitted to combine component A from each of the operating segments to make reporting unit A.

- > Operating Segments that May Be Economically Dissimilar that Are Aggregated into a Reportable Segment

55-9 If two operating segments have been aggregated into a reportable segment by applying the aggregation criteria in paragraph 280-10-50-11, it would be possible for one or more of those components to be economically

dissimilar from the other components and thus be a reporting unit for purposes of testing goodwill for impairment. That situation might occur if an entity's operating segments are based on geographic areas. The following points need to be considered in addressing this circumstance:

- a. The determination of reporting units under this Subtopic begins with the definition of an operating segment in paragraph 280-10-50-1 and considers disaggregating that operating segment into economically dissimilar components for the purpose of testing goodwill for impairment. The determination of reportable segments under Topic 280 also begins with an operating segment, but considers whether certain economically similar operating segments should be aggregated into a single operating segment or into a reportable segment.
- b. The level at which operating performance is reviewed differs between this Subtopic and Topic 280. It is the chief operating decision maker who reviews operating segments and the segment manager who reviews reporting units (components of operating segments). Therefore, a component of an operating segment would not be considered an operating segment for purposes of that Topic unless the chief operating decision maker regularly reviews its operating performance; however, that same component might be a reporting unit under this Subtopic if a segment manager regularly reviews its operating performance (and if other reporting unit criteria are met).



Excerpt from ASC 280-10

• > Aggregation Criteria

50-11 Operating segments often exhibit similar long-term financial performance if they have similar economic characteristics. For example, similar long-term average gross margins for two operating segments would be expected if their economic characteristics were similar. Two or more operating segments may be aggregated into a single operating segment if aggregation is consistent with the objective and basic principles of this Subtopic, if the segments have similar economic characteristics, and if the segments are similar in all of the following areas (see paragraphs 280-10-55-7A through 55-7C and Example 2, Cases A and B [paragraphs 280-10-55-33 through 55-36]):

- a. The nature of the products and services
- b. The nature of the production processes
- c. The type or class of customer for their products and services
- d. The methods used to distribute their products or provide their services
- e. If applicable, the nature of the regulatory environment, for example, banking, insurance, or public utilities.

To be a reporting unit, a component of an entity needs to have economic characteristics that are different from the economic characteristics of the other components of the operating segment. This criterion is used for aggregation purposes. If two or more components meet the criteria in [sections 3.4.20](#) and

3.4.30 to be a reporting unit and have similar economic characteristics, they are aggregated into one reporting unit. [350-20-35-35]

References to a ‘business’ in the following discussion apply equally to a nonprofit activity. [350-20-55-7]

 **Question 3.4.80**
What factors are considered in assessing whether components have similar economic characteristics?

Interpretive response: To determine whether components have similar economic characteristics, an entity considers factors from Topic 280 and Subtopic 350-20. The assessment of economic similarity is a matter of judgment that should be based on both qualitative and quantitative factors. [350-20-55-7]

While all factors may be relevant to the assessment, not every factor needs to be met before economic similarity can exist. Further, the list of factors (shown in the table) is not exhaustive; an entity may consider other factors it determines to be relevant.

Factors from Topic 280 [280-10-50-11]	Factors from Subtopic 350-20 [350-20-55-7]
<ul style="list-style-type: none"> — Long-term average gross margins — The nature of the products and services — The nature of the production process — The type or class of customer for the products or services — The methods used to distribute products and provide services. — If applicable, the nature of the regulatory environment (e.g. banking, insurance, public utilities) 	<ul style="list-style-type: none"> — The way an entity operates its business and the nature of those operations — Whether goodwill is recoverable from the separate operations of each component business or from two or more component businesses working together — The extent to which the component businesses share assets and other resources (e.g. evidenced by extensive transfer pricing mechanisms) — Whether the components support and benefit from common R&D projects

 **Example 3.4.10**
Identifying reporting units

Retailer has identified three operating segments under Topic 280: Brands A, B and C. Retailer aggregates these operating segments into one reportable segment because they meet the aggregation criteria in paragraph 280-10-50-11.

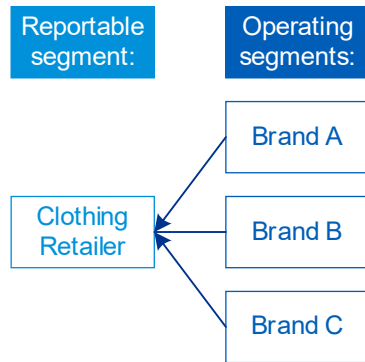

To identify its reporting units under Subtopic 350-20, Retailer begins with its operating segments and evaluates whether there are reporting units one level below the operating segment level. Within the operating segments, each division in the following discussion meets the definition of a business under Topic 805 and has discrete financial information (see [section 3.4.20](#)), which is regularly reviewed by the segment manager (see [section 3.4.30](#)).

Brand A: Men’s clothing, Women’s clothing, Cosmetics

Retailer concludes that the Men’s and Women’s divisions are economically similar and should be aggregated into one reporting unit, while the Cosmetics division should be a separate reporting unit. This conclusion is based on the following reasons.

- The Men’s and Women’s divisions share production facilities, use similar production processes and share employees. The distribution channels for the two divisions are the same because the two lines of clothing are carried in the same stores.
- The Cosmetics division operates from separate facilities because the products are very different from the other two divisions, with very different gross margins.
- There is some similarity in the distribution channels between the Cosmetics division and the Men’s and Women’s divisions, but the Cosmetics products also are distributed to stores that do not carry clothing.

Brand B: Women’s sportswear, Women’s dresses

Retailer concludes that the two divisions are economically similar and should be aggregated into one reporting unit. This conclusion is reached because the operations of the two divisions are highly integrated and have similar economic characteristics.

Brand C: United States, Europe

Retailer concludes that the two geographic areas are not economically similar and should not be aggregated into one reporting unit. This conclusion is reached because the businesses are operated differently in the two regions, goodwill is recoverable from each component acting separately, and assets and other resources are not shared. Although the components benefit from the same R&D projects, this factor does not outweigh the other considerations.

Conclusion

As a result of its analysis, Retailer has five reporting units.

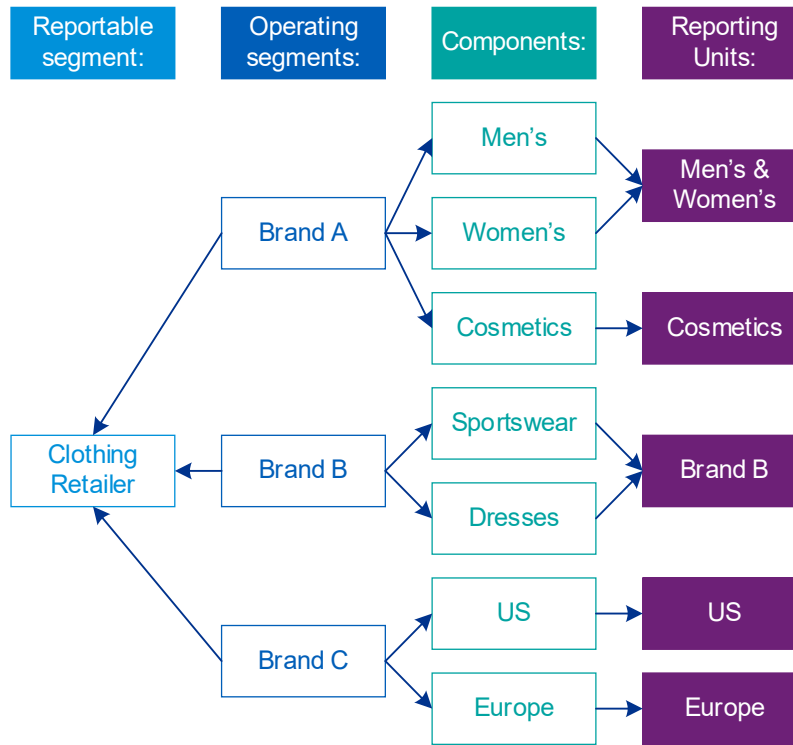

Question 3.4.90

Can components of different operating segments be aggregated into a single reporting unit if they are economically similar?

Interpretive response: No. Components that are economically similar but part of different operating segments cannot be combined into a single reporting unit. This is because a reporting unit is the operating segment or one level below (see [Question 3.4.30](#)). For the same reason, operating segments cannot be aggregated to form reporting units. [350-20-55-8]



Question 3.4.100

How do regular transfers of assets and liabilities between components affect the determination of reporting units?

Interpretive response: One of the factors in Subtopic 350-20 suggesting economic similarity is the sharing of assets and other resources among components of an operating segment. Similarly, transfers of assets and

liabilities between components on a regular basis may demonstrate economic similarity – e.g. the transfer of raw materials in the production of inventory. [350-20-55-7(c)]

However, care is required because these factors that indicate economic similarity may in some cases indicate that the component does not meet the definition of a business (see [Question 3.4.50](#)). In that case, the component could not be a reporting unit on its own and the aggregation criteria are not relevant.

3.4.50 Revising reporting units



Excerpt from ASC 350-20

> Reorganization of Reporting Structure

35-45 When an entity reorganizes its reporting structure in a manner that changes the composition of one or more of its reporting units, the guidance in paragraphs 350-20-35-39 through 35-40 shall be used to reassign assets and liabilities to the reporting units affected. However, goodwill shall be reassigned to the reporting units affected using a relative fair value allocation approach similar to that used when a portion of a reporting unit is to be disposed of (see paragraphs 350-20-40-1 through 40-7).

35-46 For example, if existing reporting unit A is to be integrated with reporting units B, C, and D, goodwill in reporting unit A would be assigned to units B, C, and D based on the relative fair values of the three portions of reporting unit A prior to those portions being integrated with reporting units B, C, and D.



Question 3.4.110

When are reporting units revised, and how is a change accounted for?

Interpretive response: An entity reassesses its reporting units when its reporting structure changes. Such a change could be at the level of operating segments in applying Topic 280, or at the component level. [350-20-35-45 – 35-46]

However, other changes that may warrant reassessing reporting units include:

- changes in the composition of a component that change whether it still meets the definition of a business, or the continued availability of discrete financial information (see [section 3.4.20](#)); and
- whether components have similar economic characteristics (see [section 3.4.40](#));

As a result, an entity should remain alert for significant changes in the economic environment in which these components operate as well as any changes in its structure – e.g. following a business combination or upon the announcement of a global restructuring plan.

A change in grouping that results from changes in facts and circumstances is a change in estimate under Topic 250. Therefore, the change is accounted for prospectively and previously issued financial statements are not reconsidered. An entity should disclose a change in grouping and the circumstances of the change (see [Question 10.3.10](#)). For a more in-depth discussion of changes in estimates, see section 3.4 of KPMG Handbook, [Accounting changes and error corrections](#). [250-10-45-17]

The reassignment of goodwill following a change in reporting units is discussed in [Question 5.4.130](#).

4. When to test

Detailed contents

4.1 How the standards work

4.2 Mandatory annual testing

Questions

- 4.2.10 Must a single date be chosen for annual impairment testing?
- 4.2.20 What are factors to consider in selecting a date to perform the annual goodwill impairment testing?
- 4.2.30 Can the annual quantitative test be avoided?
- 4.2.40 Can an entity change the date of annual impairment testing of goodwill?
- 4.2.50 If an annual testing date is changed, can the period between goodwill impairment testing dates exceed 12 months?
- 4.2.60 Can an entity change the date of annual impairment testing of indefinite-lived intangible assets?
- 4.2.70 If an entity acquires goodwill shortly before its annual impairment test, is it required to test the newly acquired goodwill as of the annual test date?
- 4.2.80 If newly acquired goodwill is stated at a provisional amount during the measurement period, what are the implications for impairment testing?
- 4.2.90 Can an entity make its best estimate of an impairment loss if not yet complete when the financial statements are issued?

Examples

- 4.2.10 Annual testing dates
- 4.2.20 Adjusting a goodwill impairment loss as a measurement period adjustment

4.3 Trigger-based testing

- 4.3.10 Overview
- 4.3.20 Negative share price trends
- 4.3.30 Internal reorganizations
- 4.3.40 Testing date relief for private companies and NFPs

Questions

- 4.3.10 Is the threshold for trigger-based testing of long-lived assets the same as for goodwill and indefinite-lived intangible assets?

- 4.3.20 How many indicators of impairment are required to trigger impairment testing?
- 4.3.30 What are examples of indicators of impairment for goodwill?
- 4.3.40 What additional factors should be considered when evaluating triggering events for goodwill impairment testing?
- 4.3.50 What are examples of indicators of impairment for assets other than goodwill?
- 4.3.60 If an indicator of impairment exists for an individual asset that is part of a larger group, must the larger group be tested for impairment?
- 4.3.70 Are negative share price trends an indicator of goodwill impairment?
- 4.3.80 If an entity's negative share price trend is consistent with the industry, does it have an indicator of goodwill impairment?
- 4.3.90 Are negative share price trends relevant for assets other than goodwill?
- 4.3.100 Does reorganizing the unit(s) of account for indefinite-lived intangible assets trigger impairment testing?
- 4.3.110 Does reorganizing reporting units trigger goodwill impairment testing?
- 4.3.120 Does a change in asset groups trigger long-lived asset impairment testing?
- 4.3.130 What considerations apply in electing the testing date accounting alternative?
- 4.3.140 What is the scope of the relief provided by the testing date accounting alternative?
- 4.3.150 In applying the testing date accounting alternative, what constitutes interim financial reporting?
- 4.3.160 What are the implications for the testing date accounting alternative if an entity's reporting frequency changes?

Examples

- 4.3.10 Determining the date of an impairment trigger
- 4.3.20 Testing date accounting alternative – annual reporting date only
- 4.3.30 Testing date accounting alternative – interim reporting

4.4 Sequence of impairment testing

Questions

- 4.4.10 In what order are assets tested for impairment?
- 4.4.20 Does the impairment of goodwill trigger impairment testing for the long-lived assets in that reporting unit?

Example

4.4.10 Testing other assets for impairment before goodwill

4.5 Impairment testing at subsidiary level

Question

4.5.10 Does a goodwill impairment loss in a subsidiary's financial statements trigger impairment testing in consolidation?

4.1 How the standards work

When to test for impairment is dictated by the nature of the asset. The timing of an impairment test may be event-driven due to the existence of impairment indicators (e.g. operating losses) or may be performed on an annual basis as required by the relevant Subtopic.

The following diagram is an adaptation of the impairment diagram in [chapter 1](#), showing the timing of impairment tests as part of the model for each type of nonfinancial asset.

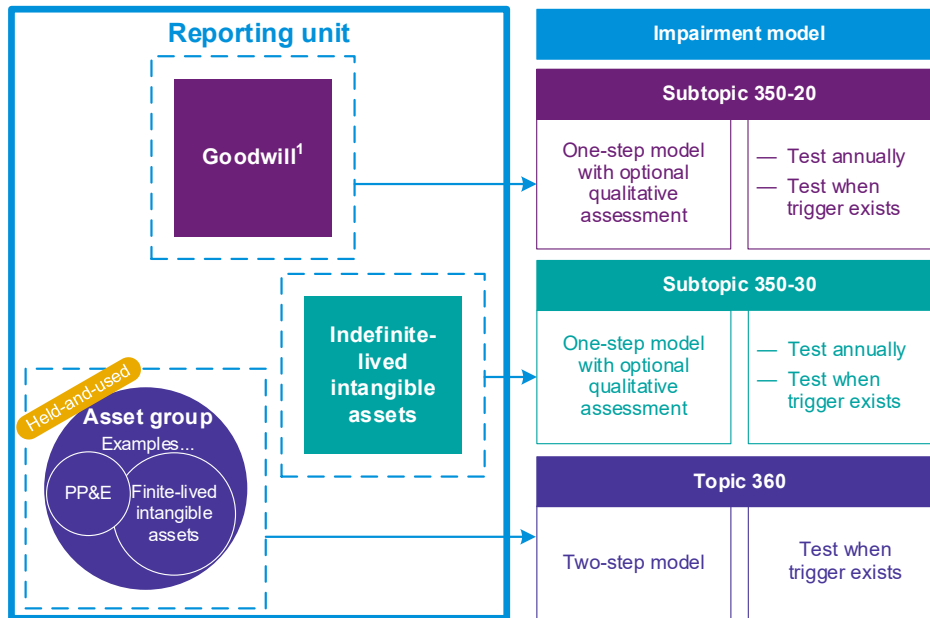

Note 1: Assumes (1) the entity has not elected the goodwill amortization accounting alternative (see chapter 11); and (2) ASU 2017-04 has been adopted (see Appendix A).

Regardless of why an impairment test is performed, the sequencing is based on the nature of the asset as shown in the following diagram.

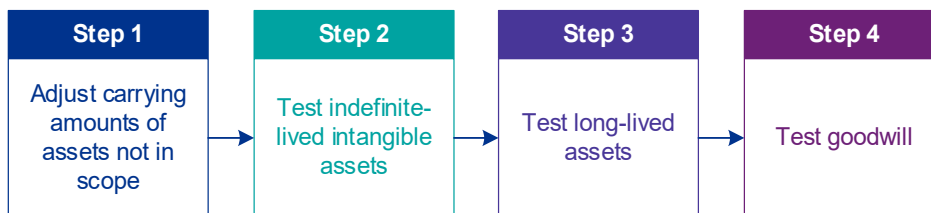

This chapter refers to the following throughout:

- an indefinite-lived intangible asset, although the unit of account might be a grouping of such assets (see [section 3.2](#)); and
- an asset group, although the unit of account might be a single asset (see [section 3.3](#)).

4.2 Mandatory annual testing



Excerpt from ASC 350-20

- > When to Test Goodwill for Impairment

35-28 Goodwill of a reporting unit shall be tested for impairment on an annual basis and between annual tests in certain circumstances (see paragraph 350-20-35-30). The annual goodwill impairment test may be performed any time during the fiscal year provided the test is performed at the same time every year. Different reporting units may be tested for impairment at different times.



Excerpt from ASC 350-30

- > Intangible Assets Not Subject to Amortization

35-18 An intangible asset that is not subject to amortization shall be tested for impairment annually and more frequently if events or changes in circumstances indicate that it is more likely than not that the asset is impaired.

Both goodwill and indefinite-lived intangible assets are required to be tested for impairment annually. However, impairment testing may occur more frequently if impairment indicators are identified between annual testing dates. [350-20-35-28, 350-30-35-18]



Question 4.2.10

Must a single date be chosen for annual impairment testing?

Interpretive response: No. An entity may choose any date to perform its annual tests and the date may be different for each unit of account (e.g. each reporting unit). However, the annual goodwill impairment test needs to be performed for each reporting unit at the same time each year. [350-20-35-28, 350-30-35-18]

Notwithstanding the flexibility in the standards to choose a different date for each unit of account, in our experience typically a single impairment testing date is chosen for practical reasons.



Question 4.2.20

What are factors to consider in selecting a date to perform the annual goodwill impairment testing?

Interpretive response: In selecting impairment testing dates for goodwill, management should consider external financial reporting deadlines (e.g. Form 10-Q, Form 10-K). Selecting a testing date that corresponds with reporting period-ends heightens the potential that management will not complete the testing by the financial statement filing deadline. On that basis, a calendar year-end entity might choose October 1 as its annual impairment testing date, for example.

Other relevant factors include the timing of testing indefinite-lived intangible assets, the internal reporting cycle for budgets and forecasts, and the availability of appropriate resources to perform the impairment test.

Regardless of the date selected, management continues to assess its previous conclusions through to each reporting date to ensure they remain appropriate and no subsequent impairment indicators have arisen that require an interim impairment assessment (see [section 4.3](#)).



Example 4.2.10

Annual testing dates

ABC Corp. is a calendar year-end company with two reporting units; each reporting unit includes an indefinite-lived intangible asset:

- Reporting Unit 1 (contains Trade Name 1)
- Reporting Unit 2 (contains Trade Name 2).

Scenario 1: Reporting units and trade names tested on different dates

ABC tests the trade names on March 1 each year and the reporting units on October 1 each year.

Having tested the trade names on March 1, ABC has to continually assess whether events or circumstances arising after March 1 indicate that it is more likely than not that the trade names have been impaired.

Depending on the circumstances identified in the annual goodwill impairment test for the reporting units on October 1, this staggered approach could result in:

- additional effort to monitor potential indicators of impairment; and
- trigger-based impairment testing of the trade names either immediately before testing the reporting units, or between March 1 and October 1, if impairment triggers are identified (see [Question 4.3.50](#)).

Scenario 2: Reporting units and trade names tested on the same date

ABC tests both the trade names and reporting units on October 1 each year. This approach may mean that testing each trade name on the same date as its related reporting unit is less burdensome.



Question 4.2.30

Can the annual quantitative test be avoided?

Interpretive response: Yes, if the entity elects to carry out a qualitative assessment and concludes that it is *not* more likely than not that an indefinite-lived intangible asset's or reporting unit's fair value is less than its carrying amount. In that case, the entity need not perform the quantitative test. The qualitative assessment, which is elective for each indefinite-lived intangible asset or reporting unit, is the subject of [chapter 6](#). [350-20-35-3, 350-30-35-18A]



Question 4.2.40

Can an entity change the date of annual impairment testing of goodwill?

Interpretive response: Yes. An entity may change the date of an annual goodwill impairment test if events or circumstances warrant (e.g. a significant acquisition).

Such a change is a change in the method of applying an accounting principle under Topic 250 that must be 'preferable'. Regardless of materiality, the change is generally accounted for prospectively. This is because retrospective application under Topic 250 is deemed impracticable if: [250-10-45-2, 45-9]

- it would require assumptions about management's intent in a prior period that cannot be independently substantiated; or
- it requires significant estimates of amounts, and it is impossible to objectively distinguish information about those estimates that provides evidence of circumstances that existed on the date at which those amounts would be measured (i.e. indistinguishable from the use of hindsight).

If a public entity changes an annual goodwill impairment testing date, the SEC staff does not require a preferability letter if: [2014 AICPA Conf]

- the entity determines that the change does not result in a material change in the method of applying the accounting principle; this requirement may be met even if goodwill is material to the financial statements; and
- the change in testing date is prominently disclosed.

Frequent changes to the date(s) of an entity's goodwill impairment testing may call into question whether the changes are indeed warranted by events or circumstances. In such circumstances, it may appear that the entity is masking an impairment loss or manipulating the timing of recognition.



Question 4.2.50

If an annual testing date is changed, can the period between goodwill impairment testing dates exceed 12 months?

Interpretive response: No. Under no circumstances should more than 12 months elapse between goodwill impairment testing dates. [\[SEC A&D G2\]](#)

If the period between the original and revised annual impairment testing dates would exceed 12 months, additional testing is required to ensure that each reporting unit is tested at least once in a 12-month period. For example, an entity wants to change its annual testing date from February to September. To ensure that goodwill is tested at least annually, the entity could test the goodwill for impairment in both February Year 1 and September Year 1 (i.e. make the change in Year 1) or perform additional testing in February Year 2 (i.e. make the change in Year 2).



Question 4.2.60

Can an entity change the date of annual impairment testing of indefinite-lived intangible assets?

Interpretive response: Subtopic 350-30 does not require that the annual impairment test of indefinite-lived intangible assets be performed on the same date each year. Therefore, a change in the annual testing date is not a change in the method of applying an accounting principle.

However, similar to goodwill in [Question 4.2.40](#), frequent changes to the date(s) of an entity's impairment testing of indefinite-lived intangible assets may call into question whether the entity is masking an impairment loss or manipulating the timing of recognition.



Question 4.2.70

If an entity acquires goodwill shortly before its annual impairment test, is it required to test the newly acquired goodwill as of the annual test date?

Interpretive response: It depends on whether the goodwill is allocated to a new reporting unit and/or an existing reporting unit.

To the extent that newly acquired goodwill is assigned to a new reporting unit, the entity can select an annual impairment test date later in the year, with the caveat that it must be within 12 months of the acquisition date. Subsequently, the entity can only bring the testing date back into line with its other reporting units if the change is preferable (see [Question 4.2.40](#)).

To the extent the newly acquired goodwill is assigned to an existing reporting unit, there is no exception from testing that reporting unit at the usual date – assuming the entity does not change that date (see [Question 4.2.40](#)).



Question 4.2.80

If newly acquired goodwill is stated at a provisional amount during the measurement period, what are the implications for impairment testing?

Background: The information necessary to enable an acquirer to complete the acquisition accounting following a business combination may be unavailable by the end of the first reporting period following the acquisition date. The measurement period provides a reasonable period of time (not exceeding 12 months) for the acquirer to obtain the information necessary to enable it to complete the accounting. Adjustments to provisional amounts identified during the measurement period are recognized in the current period (i.e. comparative information is not revised). The measurement period is the subject of section 10 of KPMG Handbook, [Business combinations](#).

Interpretive response: If an entity has not finalized the measurement of the carrying amount of newly acquired goodwill under Topic 805, it should use the provisional amount of goodwill when testing for impairment. There is no relief that allows impairment testing to be delayed.

That provisional amount of goodwill may be revised for a qualifying measurement period adjustment, such that the amount of a recognized impairment loss would have been different. In that case, we believe the consequential effect on the amount of impairment loss (increase or decrease) should be recognized in the current period as part of the measurement period adjustments.



Question 4.2.90

Can an entity make its best estimate of an impairment loss if not yet complete when the financial statements are issued?

Interpretive response: No. Before the adoption of ASU 2017-04 (see [Appendix A](#)), an entity was required to recognize the best estimate of an impairment loss if: [350-20-35-18 – 35-19]

- Step 2 of the goodwill impairment test was not complete at the time the financial statements were issued (available to be issued); and
- the impairment loss was probable and could be reasonably estimated.

Following the adoption of ASU 2017-04, entities must complete their impairment testing before the date the financial statements are issued (available to be issued).



Example 4.2.20 Adjusting a goodwill impairment loss as a measurement period adjustment

Parent acquired Subsidiary in a business combination on July 1, Year 1. As part of the acquisition accounting, Parent assigned provisional amounts to PP&E and certain intangible assets; as a result, the carrying amount of goodwill arising from the business combination was provisional.

All of the assets, including goodwill, with provisional carrying amounts were assigned to an existing reporting unit (RU). In its annual impairment testing in October Year 1, Parent recognized a goodwill impairment loss of \$350, which represented a full writeoff of the carrying amount of goodwill allocated to RU.

In March Year 2 Parent completed the acquisition accounting and recognized a measurement period adjustment that decreased the carrying amount of certain assets by \$100, with a corresponding increase in the carrying amount of goodwill. Deferred taxes, and any effect of measurement period adjustments on accumulated depreciation or amortization, are ignored in this example.

The table shows the effect of the measurement period adjustment, assuming no overall impact on the fair value of RU. If goodwill had been recorded at its adjusted carrying amount as of the date of acquisition, Parent would have recognized an impairment loss of \$390 – an increase of \$40. This is explained more fully in [chapter 9](#).

	Impairment test – original	Measurement period adjustments	Impairment test - adjusted
Net assets other than goodwill	\$1,000	\$(100)	\$ 900
Pre-existing goodwill in RU	300		300
Subsidiary goodwill	50	100	150
Carrying amount of RU	1,350		1,350
Fair value of RU	960		960
Deficit	390		390
Goodwill impairment loss	\$ 350		\$ 390

Parent recognizes the additional \$40 impairment loss in March Year 2 as part of the measurement period adjustments. Parent does not revise its comparative information for Year 1.

4.3 Trigger-based testing

4.3.10 Overview



Excerpt from ASC 350-20

- > When to Test Goodwill for Impairment

35-30 Goodwill of a reporting unit shall be tested for impairment between annual tests if an event occurs or circumstances change that would more likely than not reduce the fair value of a reporting unit below its carrying amount. Paragraph 350-20-35-3C(a) through (g) includes examples of such events and circumstances. Paragraphs 350-20-35-3F through 35-3G describe the process for making these evaluations.

- > Qualitative Assessment

35-3C In evaluating whether it is more likely than not that the fair value of a reporting unit is less than its carrying amount, an entity shall assess relevant events and circumstances. Examples of such events and circumstances include the following:

- Macroeconomic conditions such as a deterioration in general economic conditions, limitations on accessing capital, fluctuations in foreign exchange rates, or other developments in equity and credit markets
- Industry and market considerations such as a deterioration in the environment in which an entity operates, an increased competitive environment, a decline in market-dependent multiples or metrics (consider in both absolute terms and relative to peers), a change in the market for an entity's products or services, or a regulatory or political development
- Cost factors such as increases in raw materials, labor, or other costs that have a negative effect on earnings and cash flows
- Overall financial performance such as negative or declining cash flows or a decline in actual or planned revenue or earnings compared with actual and projected results of relevant prior periods
- Other relevant entity-specific events such as changes in management, key personnel, strategy, or customers; contemplation of bankruptcy; or litigation
- Events affecting a reporting unit such as a change in the composition or carrying amount of its net assets, a more-likely-than-not expectation of selling or disposing of all, or a portion, of a reporting unit, the testing for recoverability of a significant asset group within a reporting unit, or recognition of a goodwill impairment loss in the financial statements of a subsidiary that is a component of a reporting unit
- If applicable, a sustained decrease in share price (consider in both absolute terms and relative to peers).

35-3F The examples included in paragraph 350-20-35-3C(a) through (g) are not all-inclusive, and an entity shall consider other relevant events and circumstances that affect the fair value or carrying amount of a reporting unit in determining whether to perform the first step of the goodwill impairment test. An entity shall consider the extent to which each of the adverse events and

circumstances identified could affect the comparison of a reporting unit's fair value with its carrying amount. An entity should place more weight on the events and circumstances that most affect a reporting unit's fair value or the carrying amount of its net assets. An entity also should consider positive and mitigating events and circumstances that may affect its determination of whether it is more likely than not that the fair value of a reporting unit is less than its carrying amount. If an entity has a recent fair value calculation for a reporting unit, it also should include as a factor in its consideration the difference between the fair value and the carrying amount in reaching its conclusion about whether to perform the first step of the goodwill impairment test.

35-3G An entity shall evaluate, on the basis of the weight of evidence, the significance of all identified events and circumstances in the context of determining whether it is more likely than not that the fair value of a reporting unit is less than its carrying amount. None of the individual examples of events and circumstances included in paragraph 350-20-35-3C(a) through (g) are intended to represent standalone events or circumstances that necessarily require an entity to perform the first step of the goodwill impairment test. Also, the existence of positive and mitigating events and circumstances is not intended to represent a rebuttable presumption that an entity should not perform the first step of the goodwill impairment test.

- > Goodwill Impairment Testing by a Subsidiary

35-48 All goodwill recognized by a public or nonpublic subsidiary (subsidiary goodwill) in its separate financial statements that are prepared in accordance with generally accepted accounting principles (GAAP) shall be accounted for in accordance with this Subtopic. Subsidiary goodwill shall be tested for impairment at the subsidiary level using the subsidiary's reporting units. If a goodwill impairment loss is recognized at the subsidiary level, goodwill of the reporting unit or units (at the higher consolidated level) in which the subsidiary's reporting unit with impaired goodwill resides must be tested for impairment if the event that gave rise to the loss at the subsidiary level would more likely than not reduce the fair value of the reporting unit (at the higher consolidated level) below its carrying amount (see paragraph 350-20-35-3C(f)). Only if goodwill of that higher-level reporting unit is impaired would a goodwill impairment loss be recognized at the consolidated level.

35-49 If testing at the consolidated level leads to an impairment loss, that loss shall be recognized at that level separately from the subsidiary's loss.



Excerpt from ASC 350-30

- > Intangible Assets Not Subject to Amortization

35-18 An intangible asset that is not subject to amortization shall be tested for impairment annually and more frequently if events or changes in circumstances indicate that it is more likely than not that the asset is impaired.

35-18B In assessing whether it is more likely than not that an indefinite-lived intangible asset is impaired, an entity shall assess all relevant events and circumstances that could affect the significant inputs used to determine the fair value of the indefinite-lived intangible asset. Examples of such events and circumstances include the following:

- a. Cost factors such as increases in raw materials, labor, or other costs that have a negative effect on future expected earnings and cash flows that could affect significant inputs used to determine the fair value of the indefinite-lived intangible asset
- b. Financial performance such as negative or declining cash flows or a decline in actual or planned revenue or earnings compared with actual and projected results of relevant prior periods that could affect significant inputs used to determine the fair value of the indefinite-lived intangible asset
- c. Legal, regulatory, contractual, political, business, or other factors, including asset-specific factors that could affect significant inputs used to determine the fair value of the indefinite-lived intangible asset
- d. Other relevant entity-specific events such as changes in management, key personnel, strategy, or customers; contemplation of bankruptcy; or litigation that could affect significant inputs used to determine the fair value of the indefinite-lived intangible asset
- e. Industry and market considerations such as a deterioration in the environment in which an entity operates, an increased competitive environment, a decline in market-dependent multiples or metrics (in both absolute terms and relative to peers), or a change in the market for an entity's products or services due to the effects of obsolescence, demand, competition, or other economic factors (such as the stability of the industry, known technological advances, legislative action that results in an uncertain or changing business environment, and expected changes in distribution channels) that could affect significant inputs used to determine the fair value of the indefinite-lived intangible asset
- f. Macroeconomic conditions such as deterioration in general economic conditions, limitations on accessing capital, fluctuations in foreign exchange rates, or other developments in equity and credit markets that could affect significant inputs used to determine the fair value of the indefinite-lived intangible asset.

35-18C The examples included in the preceding paragraph are not all-inclusive, and an entity shall consider other relevant events and circumstances that could affect the significant inputs used to determine the fair value of the indefinite-lived intangible asset. An entity shall consider the extent to which each of the adverse events and circumstances identified could affect the significant inputs used to determine the fair value of an indefinite-lived intangible asset. An entity also shall consider the following to determine whether it is more likely than not that the indefinite-lived intangible asset is impaired:

- a. Positive and mitigating events and circumstances that could affect the significant inputs used to determine the fair value of the indefinite-lived intangible asset
- b. If an entity has made a recent fair value calculation for an indefinite-lived intangible asset, the difference between that fair value and the then carrying amount

- c. Whether there have been any changes to the carrying amount of the indefinite-lived intangible asset.

35-18D An entity shall evaluate, on the basis of the weight of the evidence, the significance of all identified events and circumstances that could affect the significant inputs used to determine the fair value of the indefinite-lived intangible asset for determining whether it is more likely than not that the indefinite-lived intangible asset is impaired. None of the individual examples of events and circumstances included in paragraph 350-30-35-18B(a) through (f) are intended to represent standalone events and circumstances that necessarily require an entity to calculate the fair value of an intangible asset. Also, the existence of positive and mitigating events and circumstances is not intended to represent a rebuttable presumption that an entity should not perform the quantitative impairment test as described in paragraph 350-30-35-19.

35-18E If after assessing the totality of events and circumstances and their potential effect on significant inputs to the fair value determination an entity determines that it is not more likely than not that the indefinite-lived intangible asset is impaired, then the entity need not calculate the fair value of the intangible asset and perform the quantitative impairment test in accordance with paragraph 350-30-35-19.

35-18F If after assessing the totality of events and circumstances and their potential effect on significant inputs to the fair value determination an entity determines that it is more likely than not that the indefinite-lived intangible asset is impaired, then the entity shall calculate the fair value of the intangible asset and perform the quantitative impairment test in accordance with the following paragraph.

35-19 The quantitative impairment test for an indefinite-lived intangible asset shall consist of a comparison of the fair value of the asset with its carrying amount. If the carrying amount of an intangible asset exceeds its fair value, an entity shall recognize an impairment loss in an amount equal to that excess. After an impairment loss is recognized, the adjusted carrying amount of the intangible asset shall be its new accounting basis.



Excerpt from ASC 350-40

General

> Impairment

35-1 Impairment shall be recognized and measured in accordance with the provisions of Section 360-10-35, which requires that assets be grouped at the lowest level for which there are identifiable cash flows that are largely independent of the cash flows of other groups of assets. The guidance is applicable, for example, when one of the following events or changes in circumstances occurs related to computer software being developed or currently in use indicating that the carrying amount may not be recoverable:

- a. Internal-use computer software is not expected to provide substantive service potential.
- b. A significant change occurs in the extent or manner in which the software is used or is expected to be used.
- c. A significant change is made or will be made to the software program.
- d. Costs of developing or modifying internal-use computer software significantly exceed the amount originally expected to develop or modify the software.

Implementation Costs of a Hosting Arrangement That Is a Service Contract

> Impairment

35-11 Impairment shall be recognized and measured in accordance with the provisions of Section 360-10-35 as if the capitalized implementation costs were a long-lived asset. That guidance requires that assets be grouped at the lowest level for which there are identifiable cash flows that are largely independent of the cash flows of other groups of assets. The guidance is applicable, for example, when one of the following events or changes in circumstances occurs related to the hosting arrangement that is a service contract indicating that the carrying amount of the related implementation costs may not be recoverable:

- a. The hosting arrangement is not expected to provide substantive service potential.
- b. A significant change occurs in the extent or manner in which the hosting arrangement is used or is expected to be used.
- c. A significant change is made or will be made to the hosting arrangement.



Excerpt from ASC 360-10

• > When to Test a Long-Lived Asset for Recoverability

35-21 A long-lived asset (asset group) shall be tested for recoverability whenever events or changes in circumstances indicate that its carrying amount may not be recoverable. The following are examples of such events or changes in circumstances.

- a. A significant decrease in the market price of a long-lived asset (asset group)
- b. A significant adverse change in the extent or manner in which a long-lived asset (asset group) is being used or in its physical condition
- c. A significant adverse change in legal factors or in the business climate that could affect the value of a long-lived asset (asset group), including an adverse action or assessment by a regulator
- d. An accumulation of costs significantly in excess of the amount originally expected for the acquisition or construction of a long-lived asset (asset group)
- e. A current-period operating or cash flow loss combined with a history of operating or cash flow losses or a projection or forecast that demonstrates

continuing losses associated with the use of a long-lived asset (asset group)

f. A current expectation that, more likely than not, a long-lived asset (asset group) will be sold or otherwise disposed of significantly before the end of its previously estimated useful life. The term *more likely than not* refers to a level of likelihood that is more than 50 percent.

The impairment testing of long-lived assets is trigger-based, meaning that they are tested for impairment when an event or circumstance indicates that their carrying amounts may not be recoverable. Further, even though goodwill and indefinite-lived intangible assets are tested for impairment annually, they are also tested when an event or circumstance indicates that it is more likely than not that the asset is impaired. [350-20-35-30, 350-30-35-18, 360-10-35-21]

 **Question 4.3.10**
Is the threshold for trigger-based testing of long-lived assets the same as for goodwill and indefinite-lived intangible assets?

Interpretive response: No. As shown in the table, the threshold for testing long-lived assets for impairment is different from the threshold for testing goodwill and indefinite-lived intangible assets.

Subtopics 350-20 and 30	Topic 360
Test if it is 'more likely than not' (i.e. 50% likely) that the asset is impaired. [350-20-35-30, 350-30-35-18]	Test if an indicator suggests that the asset's carrying amount 'may not be' recoverable. [360-10-35-21]

The implications of failing the threshold test are also different. For goodwill and indefinite-lived intangible assets under Subtopics 350-20 and 350-30, the next step is quantitative testing that requires fair value measurement (see [chapter 8](#)). For long-lived assets, the next step is an entity-specific recoverability test based on undiscounted cash flows (see [chapter 7](#)); fair value measurement is required only if the recoverability test fails.

 **Question 4.3.20**
How many indicators of impairment are required to trigger impairment testing?

Interpretive response: It depends. The example indicators in the Codification are not exhaustive, and none of the indicators by themselves are automatically conclusive. However, an individual indicator could provide sufficient evidence to require impairment testing. Assessing the combined effect of all indicators, both positive and negative, requires significant judgment.



Question 4.3.30
What are examples of indicators of impairment for goodwill?

Interpretive response: The goodwill indicators in Subtopic 350-20 generally focus on the effect of events or changes in circumstances on the fair value of reporting units and the entity as a whole.

The following are examples (not exhaustive) of events or circumstances that suggest a possible impairment of goodwill. [350-20-35-3C]

Macroeconomic conditions	Deterioration in general economic conditions; limitations on accessing capital; fluctuations in foreign exchange rates; other developments in equity and credit markets.
Industry and market considerations	Deterioration in the environment in which an entity operates; an increased competitive environment; a decline in market-dependent multiples or metrics (absolute terms and/or relative to peers); a change in the market for an entity's products or services; a regulatory or political development.
Cost factors	Increases in raw materials, labor or other costs that have a negative effect on earnings and cash flows.
Financial performance	Negative or declining cash flows or a decline in actual or planned revenue or earnings compared with actual and projected results of relevant prior periods.
Entity-specific events	Changes in management, key personnel, strategy or customers; contemplation of bankruptcy; litigation.
Events affecting a reporting unit	Changes in the composition or carrying amount of net assets; a more-likely-than-not expectation of selling or disposing of all, or a portion, of a reporting unit; the testing for recoverability of a significant asset group within a reporting unit; recognition of a goodwill impairment loss in the financial statements of a component subsidiary.
Share price	A sustained decrease in share price (absolute terms and/or relative to peers).



Example 4.3.10
Determining the date of an impairment trigger

The following scenarios explore whether it is appropriate to perform trigger-based impairment testing as of the reporting date, or at an earlier date with subsequent monitoring for further indicators of impairment through to the reporting date.

In both scenarios, the entity has a calendar year-end, is subject to quarterly reporting, and carries out annual impairment testing in October each year.

Scenario 1: Earthquake

Manufacturer produces high-end electronic components. An earthquake on March 10 severely disrupts the supply chain market for a key component that Manufacturer uses in its products. Manufacturer cannot easily switch suppliers because of the scarcity of the component, and supply is not expected to recover for 18 months to two years. This has a consequential negative effect on Manufacturer's operations and forecasted revenues.

Manufacturer concludes that the earthquake is an indicator of impairment and performs an impairment test as of March 10. In addition, Manufacturer continues to monitor indicators of impairment through to its reporting date of March 31.

Scenario 2: Ongoing economic distress

Retailer is currently operating in a recessionary economy and has been experiencing lower than projected sales and higher labor costs. Sales rallied during the holiday period but have slumped in Q1 as consumers reduce their spending.

In addition, a global consumer campaign to boycott certain products became an unexpected viral success and a significant percentage of consumers in Retailer's key demographic have stopped buying at Retailer's stores. The campaign launched at the start of February and its effects have continued to grow during Q1.

Lastly, store assistants at outlets in Retailer's major market began a series of one-day wildcat strikes at the start of March that continued through the quarter. The strikes disrupted service and deterred customers from entering stores.

Retailer's share price has been volatile during Q1, but in general has trended downward.

In assessing the indicators of impairment in Q1, Retailer concludes that the need for impairment testing is not caused by a single negative factor, but rather by the aggregation and cumulative effect of all the factors taken as a whole. After considering the various data points and dates, Retailer concludes that an impairment trigger occurred as a result of a combination of factors that occurred throughout Q1 and therefore Retailer tests goodwill for impairment as of March 31 (period end).



Question 4.3.40

What additional factors should be considered when evaluating triggering events for goodwill impairment testing?

Interpretive response: In reviewing financial statements, the SEC staff has indicated that it may consider publicly available information from both entity filings and external sources to assess the likelihood that an impairment triggering event for goodwill has occurred. [\[2008 AICPA Conf\]](#)

The following examples have been given by the SEC staff for management to consider as potential triggers for an interim goodwill impairment test. We believe these examples have general applicability to all entities.

- **Other impairment charges.** The recognition of impairment charges or a valuation allowance on deferred tax assets generally indicates that an interim goodwill impairment test should be performed. The SEC staff has advised that at a minimum the goodwill allocated to a reporting unit should be tested if the reporting unit is holding other assets that were impaired.
- **Cash or operating losses generated at the reporting unit level.** Recent market events and their effects on performance for the entity as a whole and for each of the reporting units should be considered. These events or conditions may negatively affect an entity's reporting units in different ways. Management should consider the cause and duration of any losses in determining whether goodwill may have been impaired.
- **Long-term negative outlook, indicators or events for related industries.** The performance of related industries, as a whole, may affect an entity or its reporting units or the assumptions management uses to assess the value of goodwill. To the extent entities within the same industry evaluate impairment indicators differently, the SEC staff may seek additional insight into how management performed its evaluation and what the key differences are.
- **Performance against expected operating results or forecasts.** The inability to meet quarterly expectations – including analyst estimates or internal forecasts for consecutive periods, or revisions to forecasts for future periods – may indicate the need to consider whether the estimated future cash flows used for impairment tests are still reasonable. To the extent future cash flows change significantly, an interim impairment test may be necessary.
- **Significant restructurings.** Restructurings such as store closures, asset disposals and layoffs may influence assumptions used in determining the recoverability of goodwill. To the extent restructurings change how management views the entity, there may be cause for reallocating goodwill among the reporting units. Such reorganizations may mean the entity needs to reevaluate the goodwill impairment indicators.



Question 4.3.50

What are examples of indicators of impairment for assets other than goodwill?

Interpretive response: The following are examples (not exhaustive) of events or circumstances that suggest a possible impairment of long-lived assets – similar to the goodwill indicators in [Question 4.3.30](#) but focused on the implications to a specific asset (asset group). [360-10-35-21]

Market price	A significant decrease in the market price of a long-lived asset (asset group).
Changes in asset use	A significant adverse change in the extent or manner in which a long-lived asset (asset group) is being used or in its physical condition.
Changes in legal factors/ business climate	A significant adverse change in legal factors or in the business climate that could affect the value of a long-lived asset (asset group), including an adverse action or assessment by a regulator.
Cost factors	An accumulation of costs significantly in excess of the amount originally expected for the acquisition or construction of a long-lived asset (asset group).
Financial performance	A current-period operating or cash flow loss combined with either a history of operating or cash flow losses or a projection or forecast that demonstrates continuing losses associated with the use of a long-lived asset (asset group).
Events affecting an asset's use	A current expectation that, more likely than not, a long-lived asset (asset group) will be sold or otherwise disposed of significantly before the end of its previously estimated useful life.

Events affecting a long-lived asset's use include the expected transfer of a long-lived asset to a lender in satisfaction of a liability. However, an entity agreeing (voluntarily or involuntarily) to make such a transfer would usually be preceded by other indicators of impairment – e.g. deteriorating financial performance.

An additional example in Subtopic 350-30 references contractual factors that could affect significant inputs used to determine the fair value of the indefinite-lived intangible asset. This circumstance could apply equally to other assets. [350-30-35-18B(c)]

Similarly, Subtopic 350-40 includes a number of examples related to internal-use software and cloud computing implementation costs, some of which don't have an obvious connection to those highlighted above but which might apply more generally. For example, the following events or circumstances may indicate impairment. [350-40-35-1, 35-11]

- The internal-use software or hosted solution to which the deferred implementation costs relate (any asset under development) is not expected to provide substantive service potential.
- Costs of developing or modifying the internal-use software (any development asset or established process) significantly exceed the amount originally expected to develop or modify the software (asset).



Question 4.3.60

If an indicator of impairment exists for an individual asset that is part of a larger group, must the larger group be tested for impairment?

Interpretive response: Not necessarily. If an impairment indicator relates only to an asset(s) that is insignificant to the asset group as a whole, we do not believe this automatically requires the asset group to be tested for impairment.

However, the entity should carefully consider whether the indicator is indeed limited to specific insignificant assets. Further, impairment indicators that affect only an insignificant portion of an asset group may indicate the assets are not grouped appropriately under Subtopic 360-10 (see [section 3.3.50](#)).

Similarly, if an impairment indicator relates only to an asset group(s) that is insignificant to the reporting unit as a whole, we do not believe this automatically requires the reporting unit to be tested for impairment. However, the entity should carefully consider whether the indicator is indeed limited to specific insignificant asset groups.

4.3.20 Negative share price trends



Question 4.3.70

Are negative share price trends an indicator of goodwill impairment?

Interpretive response: It depends. A decline in an entity's market capitalization and share price may suggest that the fair value of a reporting unit is less than its carrying amount. An entity should understand the facts and circumstances causing the decline because they may be a result of an overall market correction or may be specific to the entity's underlying business – e.g. a decline in operating results due to the loss of a significant customer. An entity should also consider the anticipated timeframe of the decline and the potential timing of recovery. These facts and circumstances need to be understood collectively to determine if it is more likely than not that an impairment exists, which may require significant judgment.

Entities should be mindful that the goodwill impairment model is not based on an other-than-temporary decline. We believe that a sustained decline in share price should not be ignored even if the price recovers (or is expected to recover) after the measurement date. If it is more likely than not that the fair value of a reporting unit has fallen below its carrying amount, an impairment test should be performed.

The SEC staff believes it is important to understand how management evaluates situations in which market capitalization is below the entity's or the reporting unit's carrying amount. An entity should consider how its share price has been affected by general market conditions and volatility. The staff has

indicated that a comparison of the entity's decline in market capitalization to relevant indices may also be meaningful. The staff acknowledged that short sellers and unrelated market conditions may cause some volatility but has cautioned entities to distinguish the effects of short-term price spikes from routine trading activity. [\[2008 AICPA Conf\]](#)

The degree of the staff's skepticism about any management decision not to evaluate goodwill for impairment at an interim reporting date will depend on the duration and severity of the indicators.



Question 4.3.80

If an entity's negative share price trend is consistent with the industry, does it have an indicator of goodwill impairment?

Interpretive response: It depends. It is important that entities evaluate all factors contributing to the share prices of industry peers relative to their own situations. However, generally speaking, an industry decline often indicates economic and/or other factors that give rise to an impairment triggering event.

For example, even with the sudden declines in the overall market stemming from COVID-19, we do not believe the current market would be considered disorderly, and the industry and overall market trends should be considered to determine if a triggering event has occurred. We believe the equity markets are generally efficient and provide a meaningful indicator of fair value. While the equity markets are presently volatile, they are active; and equity values used in impairment testing should not be adjusted for any type of illiquidity or mark-to-model techniques.



Question 4.3.90

Are negative share price trends relevant for assets other than goodwill?

Interpretive response: Yes. The examples of events and circumstances affecting assets other than goodwill in [Question 4.3.50](#) exclude market capitalization and share price trends. The relevance of those factors will depend on the specific facts and circumstances, but these indicators should not be ignored. For example, a decline in share prices may signal weakening demand for a product, resulting in reduced cash inflows and potential impairment for an asset group.

4.3.30 Internal reorganizations



Excerpt from ASC 350-20

> Reorganization of Reporting Structure

35-45 When an entity reorganizes its reporting structure in a manner that changes the composition of one or more of its reporting units, the guidance in paragraphs 350-20-35-39 through 35-40 shall be used to reassign assets and liabilities to the reporting units affected. However, goodwill shall be reassigned to the reporting units affected using a relative fair value allocation approach similar to that used when a portion of a reporting unit is to be disposed of (see paragraphs 350-20-40-1 through 40-7).

35-46 For example, if existing reporting unit A is to be integrated with reporting units B, C, and D, goodwill in reporting unit A would be assigned to units B, C, and D based on the relative fair values of the three portions of reporting unit A prior to those portions being integrated with reporting units B, C, and D.

> Disposal of All or a Portion of a Reporting Unit

40-7 When only a portion of goodwill is allocated to a business or nonprofit activity to be disposed of, the goodwill remaining in the portion of the reporting unit to be retained shall be tested for impairment in accordance with paragraphs 350-20-35-3A through 35-13 using its adjusted carrying amount.



Excerpt from ASC 350-30

> Unit of Accounting for Purposes of Testing for Impairment of Intangible Assets Not Subject to Amortization

35-27 If, based on a change in the way in which intangible assets are used, an entity combines as a unit of accounting for impairment testing purposes indefinite-lived intangible assets that were previously tested for impairment separately, those intangible assets shall be separately tested for impairment in accordance with paragraphs 350-30-35-18 through 35-20 prior to being combined as a unit of accounting.

A reorganization may be physical (e.g. disposing of assets) or related to the reporting structure (e.g. a change in operating segments). In such cases, an entity reassesses its units of account for impairment testing; see [Question 3.2.50](#) (indefinite-lived intangible assets), [section 3.3.50](#) (asset groups) and [section 3.4.50](#) (reporting units).



Question 4.3.100

Does reorganizing the unit(s) of account for indefinite-lived intangible assets trigger impairment testing?

Interpretive response: In some cases, yes. If an indefinite-lived intangible asset tested for impairment individually is later combined with one or more other indefinite-lived intangible assets as a single unit of account, the asset is first tested for impairment as a single asset before testing it for impairment as part of the combined unit of account; this requirement cannot be avoided. [350-30-35-27]

If an indefinite-lived intangible asset is removed from a larger unit of account, there is no specific requirement to perform an impairment test. However, an entity should carefully consider whether there is an indicator of impairment for the combined unit of account because it would not be appropriate to reorganize to avoid an impairment loss. [Question 9.2.10](#) discusses the carrying amount of the asset removed from the unit of account.



Question 4.3.110

Does reorganizing reporting units trigger goodwill impairment testing?

Interpretive response: Generally, yes. If reporting units are reorganized, an entity should carefully consider whether there is an indicator of impairment that would require impairment testing; this includes considering the reasons for the reorganization. For example, when an entity changes its segment management structure by reassigning portions of its business to different segment managers, this may have been intended to improve poor operating results. It would not be appropriate to reorganize to avoid an impairment loss.

If the entity concludes that there is an indicator of impairment, we believe a goodwill impairment test should be performed immediately before and after the reorganization. By doing this, an entity is able to demonstrate that the reorganization does not mask a goodwill impairment loss. If the entity identifies impairment in its pre-reorganization impairment test, that loss should be recognized – even if there is no loss from the post-reorganization impairment test.



Question 4.3.120

Does a change in asset groups trigger long-lived asset impairment testing?

Interpretive response: It depends. If there is a change in asset groups, it means a transaction or other event occurred that changes how the entity's assets work together to generate cash flows that are largely independent (see [section 3.3](#)).

When a change occurs, an entity should carefully consider whether there is an indicator of impairment that would require impairment testing; this includes considering the reasons for the change. For example, a cost containment exercise that changes how infrastructural assets are used by divisions and has the effect of changing the entity's asset groups, may have been intended to improve poor operating results.

4.3.40 Testing date relief for private companies and NFPs



Excerpt from ASC 350-20

Accounting Alternatives

15-4A A private company or not-for-profit entity may make an accounting policy election to apply the accounting alternative for a goodwill impairment triggering event evaluation to goodwill subsequently accounted for in accordance with Subtopic 350-20.

> Accounting Alternative for a Goodwill Impairment Triggering Event Evaluation

35-83 The following guidance for goodwill applies to entities within the scope of paragraph 350-20-15-4A that elect the accounting alternative for a goodwill impairment triggering event evaluation.

35-84 An entity may elect to perform its goodwill impairment triggering event evaluation only as of the end of each reporting period, whether the reporting period is an interim or annual period. That is, the entity would not evaluate goodwill impairment triggering events and measure any related impairment during the reporting period. An entity electing the accounting alternative shall assess whether events or circumstances have occurred that would require an entity to test goodwill for impairment as follows:

- a. For an entity that has elected the accounting alternative for amortizing goodwill, the entity's evaluation of a triggering event, as described in paragraph 350-20-35-66, shall be performed only as of each reporting date.
- b. For an entity that has not elected the accounting alternative for amortizing goodwill:
 1. If the entity performs its annual goodwill impairment test as of the end of the reporting period, the entity shall not evaluate its goodwill for impairment during the reporting period as described in paragraph 350-20-35-30.
 2. If the entity performs its annual goodwill impairment test on a date other than the end of the reporting period (in accordance with paragraph 350-20-35-28), the entity's evaluation of impairment between annual goodwill impairment tests (as described in paragraph 350-20-35-30) shall be performed only as of the end of a reporting period.

35-85 An entity electing this accounting alternative shall apply it only to goodwill evaluated in accordance with this Subtopic. This accounting alternative does not change the following:

- a. The requirement to assess other assets for impairment (for example, long-lived assets and indefinite-lived intangibles) under existing guidance. If the impairment test related to other assets would have resulted in a goodwill impairment triggering event, an entity electing this accounting alternative should consider the results of an impairment test related to other assets in connection with its goodwill impairment test only as of its annual goodwill impairment testing date and the reporting date, whether that date is an interim or annual reporting date, as applicable.
- b. The requirements to test the remaining goodwill for impairment if only a portion of goodwill is allocated to a business or nonprofit activity to be disposed of in accordance with paragraph 350-20-40-7.

35-86 An entity shall not apply this guidance retroactively to interim periods for which annual financial statements have already been issued.



Excerpt from ASC 350-20

> Illustrations

- > Example 1: Illustration of the Accounting Alternative for a Goodwill Impairment Triggering Event Evaluation

55-27 This Example illustrates the effect of the accounting alternative for a goodwill impairment triggering event evaluation on the impairment conclusion for an entity within the scope of paragraph 350-20-15-4A. This Example is not indicative of every outcome that may occur because facts and circumstances surrounding triggering events are unique to each entity.

55-28 Entity A adopted the accounting alternative for a goodwill impairment triggering event evaluation and performs a goodwill impairment triggering event evaluation only as of the end of each reporting period. Entity A also adopted the accounting alternative for amortizing goodwill in accordance with paragraph 350-20-05-5 and elected to perform an impairment test for goodwill at the entity level upon the occurrence of a triggering event only. During the second quarter, Entity A lost a significant customer. However, Entity A was able to replace that customer late in the third quarter of the same year, and the entity's operations returned to previously forecasted levels by the annual reporting date.

55-29 If Entity A reports only annually, then it would evaluate the facts and circumstances as of the annual reporting date and may conclude that no triggering event exists; therefore, no further goodwill impairment testing would be necessary. Alternatively, if Entity A reports on both a quarterly basis and an annual basis, then it would evaluate the facts and circumstances as of the end of each quarter and may conclude that the loss of the significant customer represents a goodwill impairment triggering event requiring additional impairment testing as of the end of the second quarter.

Private companies and NFPs, including those that are conduit bond obligors, may elect to apply the accounting alternative for a goodwill impairment triggering event evaluation. This accounting alternative allows private companies and NFPs to evaluate a goodwill impairment triggering event only as of each reporting date (annual or interim). [350-20-15-4A, 35-84],

This testing date accounting alternative applies regardless of whether the entity has elected to amortize goodwill (see chapter 11). [350-20-15-6]

This alternative does not change the timing of the triggering event assessments for long-lived assets or the requirements to test goodwill in other situations (e.g. upon disposal of a portion of a reporting unit).



Question 4.3.130

What considerations apply in electing the testing date accounting alternative?

Interpretive response: Once elected, the accounting alternative is applied prospectively from the date of adoption. Similar to other private company accounting alternatives, a private company or NFP electing to adopt this new alternative after the effective date may do so without having to demonstrate preferability. [350-20-65-4]

However, after initial adoption, any subsequent election in or out of the alternative is subject to a preferability assessment. If an entity applying the alternative subsequently becomes a public company, it will need to retrofit its financial statements to be compliant with public company requirements and retroactively assess triggering events between reporting dates (and potentially recognize additional impairment losses). [ASU 2021-03.BC32]



Question 4.3.140

What is the scope of the relief provided by the testing date accounting alternative?

Interpretive response: If elected, the testing date accounting alternative requires private companies and NFPs to assess triggering events only as of each reporting date (interim or annual), instead of during a reporting period. Further, when performing a goodwill impairment test, these entities use the financial information as of the end of the applicable reporting period. [350-20-35-84]

The alternative may provide relief for eligible entities that report only annually, but it does not allow an entity that reports GAAP interim financial information to delay the triggering event assessment to the annual reporting date. Eligible entities that report GAAP interim financial information are still required to evaluate triggering events as of each interim reporting date. However, they do not have to monitor and evaluate triggering events during the interim period. This means, for example, when an entity reports interim financial information for the quarter ended March 31, it determines whether an impairment test is

required as of March 31 but does not have to evaluate whether an impairment test was required between January 1 and March 30. [350-20-35-84]

The alternative also does not change requirements to test goodwill in other situations (e.g. upon disposal of a portion of a reporting unit) or when goodwill is included in a disposal group classified as held-for-sale. [350-20-35-85]



Example 4.3.20

Testing date accounting alternative – annual reporting date only

ABC Corp. is a private company that reports financial information only on an annual basis; it has no interim reporting requirements. ABC elected the accounting alternative for amortizing goodwill and therefore performs an impairment test for goodwill only when a triggering event occurs.

ABC elects the accounting alternative for goodwill impairment triggering events. Because ABC only reports financial information annually, it does not evaluate triggering events throughout the year.

During Q2, ABC lost a major customer. However, it was able to replace the customer in Q4 and operations returned to expected levels by year-end.

At its annual reporting date, ABC evaluates whether triggering events exist. It concludes that the facts and circumstances as of the reporting date do not indicate it is more likely than not that goodwill is impaired because it was able to recover from the loss of a significant customer. Therefore, no further impairment testing is needed.



Example 4.3.30

Testing date accounting alternative – interim reporting

ABC Corp. is a private company that reports financial information to its lenders on a quarterly basis. It elected the accounting alternative for amortizing goodwill and therefore performs an impairment test for goodwill only when a triggering event occurs.

ABC elects the accounting alternative for goodwill impairment triggering events. Debt covenants require ABC to provide financial information that is prepared in accordance with GAAP as of the interim reporting date, and therefore ABC must evaluate goodwill triggering events as of the end of each quarter.

During Q2, ABC lost a major customer. However, it was able to replace the customer in Q4 and operations returned to expected levels by year-end.

ABC needs to evaluate the facts and circumstances as of the end of each quarter – i.e. at the end of both Q2 and Q3. In performing its Q2 evaluation, ABC may conclude it is more likely than not that an impairment has occurred because of the loss of the major customer; or that factor, in conjunction with other circumstances, might result in a Q3 impairment test.



Question 4.3.150

In applying the testing date accounting alternative, what constitutes interim financial reporting?

Interpretive response: Although the accounting alternative requires triggering event assessment as of all reporting dates (whether interim or annual), the FASB did not define what is meant by a reporting period and what level of interim financial information needs to be provided to require a triggering event assessment on an interim basis. It observed that many entities provide some level of interim financial information to their users that complies with the recognition and measurement principles of GAAP, but such information may be less than a full set of GAAP-compliant financial statements with notes. [ASU 2021-03.BC28]

The FASB observed that entities should already be evaluating triggering events any time they report in compliance with GAAP and the alternative should only shift the timing of when those events are evaluated to the end of the period. The FASB does not expect this alternative to change an entity's understanding of when it reports GAAP-compliant interim financial information. [ASU 2021-03.BC29]

Entities will need to carefully evaluate their reporting requirements (e.g. terms of lending arrangements) to determine whether their interim financial information is required to be in compliance with GAAP. For example, if debt covenants require an entity to provide a balance sheet with goodwill or information that includes amounts affected by goodwill (e.g. net income, if an impairment did exist), the entity needs to determine if it is required to comply (or elects to comply) with the recognition and measurement aspects of GAAP for that information. If it is or does, then it must evaluate triggering events on an interim basis, even if a full set of financial statements with disclosures is not issued.



Question 4.3.160

What are the implications for the testing date accounting alternative if an entity's reporting frequency changes?

Interpretive response: Entities applying the testing date accounting alternative cannot retroactively assess triggering events in interim periods for which annual financial statements have already been issued. We understand this applies when a private company or NFP has a change in reporting frequency.

For example, in Year 1 an entity reports only annually and elects the testing date accounting alternative. In Year 2, the entity is required to report on a quarterly basis with comparative financial information. In Year 2, the entity would not need to evaluate triggering events for the comparative quarterly reporting periods because the Year 1 annual financial statements have already been issued.

An entity that no longer qualifies to use the accounting alternative (i.e. because it becomes a public entity) would have to retroactively assess triggering events between reporting dates (and potentially recognize additional impairment losses) to be compliant with public company requirements. See [Question 4.3.130](#).

4.4 Sequence of impairment testing



Excerpt from ASC 350-20

- > When to Test Goodwill for Impairment

35-31 If goodwill and another asset (or asset group) of a reporting unit are tested for impairment at the same time, the other asset (or asset group) shall be tested for impairment before goodwill. For example, if a significant asset group is to be tested for impairment under the Impairment or Disposal of Long-Lived Assets Subsections of Subtopic 360-10 (thus potentially requiring a goodwill impairment test), the impairment test for the significant asset group would be performed before the goodwill impairment test. If the asset group was impaired, the impairment loss would be recognized prior to goodwill being tested for impairment.

35-32 This requirement applies to all assets that are tested for impairment, not just those included in the scope of the Impairment or Disposal of Long-Lived Assets Subsections of Subtopic 360-10.



Excerpt from ASC 360-10

- • > Effect of Goodwill when Grouping

35-27 Other than goodwill, the carrying amounts of any assets (such as accounts receivable and inventory) and liabilities (such as accounts payable, long-term debt, and asset retirement obligations) not covered by this Subtopic that are included in an asset group shall be adjusted in accordance with other applicable generally accepted accounting principles (GAAP) before testing the asset group for recoverability. Paragraph 350-20-35-31 requires that goodwill be tested for impairment only after the carrying amounts of the other assets of the reporting unit, including the long-lived assets covered by this Subtopic, have been tested for impairment under other applicable accounting guidance.

Question 4.4.10
In what order are assets tested for impairment?

Interpretive response: All assets in a reporting unit that require impairment testing are tested for impairment before goodwill is tested. The carrying amounts of assets are decreased for any impairment losses, with a corresponding adjustment to the carrying amount of the reporting unit in which those assets reside. [350-20-35-31]

As a general principle, the assets are tested in the order shown in the diagram, with the first step being to adjust the carrying amounts of assets that are not in the scope of the impairment models (e.g. working capital).

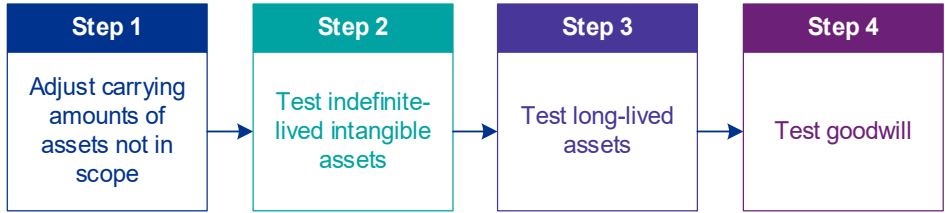

The practical effect of this sequencing is that if the reporting unit’s carrying amount is reduced through these other impairment tests, it is less likely that the adjusted carrying amount will exceed the reporting unit’s fair value.

Example 4.4.10
Testing other assets for impairment before goodwill

ABC Corp. has one reporting unit, which aligns with its single operating segment. Before performing its annual goodwill impairment test, ABC tested its indefinite-lived intangible assets and long-lived assets for impairment. As a result of these analyses, ABC recognized an impairment loss and adjusted the carrying amount of these assets as follows.

	Original carrying amount	Impairment loss	Updated carrying amount
Indefinite-lived intangibles	\$ 900	\$(100)	\$ 800
Long-lived assets	2,300	(750)	1,550
Total	\$3,200	\$(850)	\$2,350

After adjusting the carrying amounts, ABC then performed its annual goodwill impairment assessment.

	Carrying amount
Goodwill	\$ 1,500
Indefinite-lived intangibles and long-lived assets (see above)	2,350
Other assets	600
Liabilities	(1,100)
Total carrying amount of reporting unit (see section 5.4)	\$ 3,350
Fair value of reporting unit (see chapter 8)	\$ 3,500
Excess (no impairment loss)	\$ 150

ABC's goodwill is not impaired because the fair value of the reporting unit exceeds its carrying amount. However, if goodwill had been tested for impairment before the indefinite-lived intangible assets and long-lived assets were tested, a different conclusion would have been reached.



Question 4.4.20

Does the impairment of goodwill trigger impairment testing for the long-lived assets in that reporting unit?

Interpretive response: Not necessarily. Subtopic 350-20 requires that an entity perform its annual test for goodwill impairment after it tests the carrying amounts of other assets of the reporting unit under other applicable GAAP, including long-lived assets that are in the scope of Topic 360 (see [Question 4.4.10](#)).

This guidance does not explicitly require impairment testing for all of the long-lived assets in a reporting unit that fails the goodwill impairment test under Subtopic 350-20. However, performing the goodwill impairment test may reveal circumstances indicating that the carrying amounts of certain long-lived assets are not recoverable, which the entity had not previously considered. In that situation, the entity should reevaluate the recoverability of the carrying amounts of the long-lived assets in the reporting unit to which the new information relates. If impairments are identified, the entity adjusts the carrying amounts of the impaired long-lived assets and reperforms the impairment test for the reporting unit.

4.5 Impairment testing at subsidiary level



Excerpt from ASC 350-20

- > Goodwill Impairment Testing by a Subsidiary

35-47 Subsidiary goodwill might arise from any of the following:

- Acquisitions that a subsidiary made prior to its being acquired by the parent
- Acquisitions that a subsidiary made subsequent to its being acquired by the parent
- Goodwill arising from the business combination in which a subsidiary was acquired that the parent pushed down to the subsidiary's financial statements.

35-48 All goodwill recognized by a public or nonpublic subsidiary (subsidiary goodwill) in its separate financial statements that are prepared in accordance with generally accepted accounting principles (GAAP) shall be accounted for in accordance with this Subtopic. Subsidiary goodwill shall be tested for impairment at the subsidiary level using the subsidiary's reporting units. If a goodwill impairment loss is recognized at the subsidiary level, goodwill of the reporting unit or units (at the higher consolidated level) in which the subsidiary's reporting unit with impaired goodwill resides must be tested for impairment if the event that gave rise to the loss at the subsidiary level would more likely than not reduce the fair value of the reporting unit (at the higher consolidated level) below its carrying amount (see paragraph 350-20-35-3C(f)). Only if goodwill of that higher-level reporting unit is impaired would a goodwill impairment loss be recognized at the consolidated level.

35-49 If testing at the consolidated level leads to an impairment loss, that loss shall be recognized at that level separately from the subsidiary's loss.



Question 4.5.10

Does a goodwill impairment loss in a subsidiary's financial statements trigger impairment testing in consolidation?

Interpretive response: It depends. Goodwill reported by a subsidiary in its stand-alone US GAAP financial statements is tested for impairment at the subsidiary level using the subsidiary's reporting units. An impairment loss recognized at the subsidiary level is not simply recognized as-is in consolidation. Instead, impairment at the subsidiary level is an example of an event that could trigger an impairment test of goodwill at the higher level (see [Question 4.3.30](#)). [350-20-35-48]

If the parent concludes that the subsidiary's goodwill impairment loss is an indicator of impairment in the consolidated financial statements, the following differences arise.

- The parent will determine its reporting unit(s) from a consolidated perspective. See [section 3.4](#).
- Even if one of the reporting units in consolidation exactly corresponds to the subsidiary's reporting unit that gave rise to the impairment loss, the carrying amount of the reporting unit in consolidation will likely differ from that in the subsidiary's stand-alone financial statements (even if pushdown accounting was applied).

Further, if a subsidiary reports on a lag basis, an impairment loss could be recognized in the parent's consolidated financial statements earlier than in the subsidiary's stand-alone financial statements. This is because the parent is evaluating goodwill for impairment in the period in which the impairment loss occurs at the consolidated level.

5. Carrying amount

Detailed contents

5.1 How the standards work

5.2 Indefinite-lived intangible assets

5.3 Asset groups

Questions

- 5.3.10 When is goodwill included in an asset group's carrying amount?
- 5.3.20 Are enterprise assets assigned to the underlying asset groups that they support?
- 5.3.30 Are liabilities included in an asset group's carrying amount?
- 5.3.40 Does a lessee include lease liabilities in an asset group's carrying amount?
- 5.3.50 Is working capital included in an asset group's carrying amount?
- 5.3.60 Are AROs included in an asset group's carrying amount?
- 5.3.70 Are pension obligations included in an asset group's carrying amount?
- 5.3.80 Is an accumulated CTA included in an asset group's carrying amount?
- 5.3.90 How does a hedged forecasted transaction affect the carrying amount of an asset group?

5.4 Reporting units

- 5.4.10 Overview
- 5.4.20 Allocating liabilities to reporting units
- 5.4.30 Allocating assets (other than goodwill) and liabilities to multiple reporting units
- 5.4.40 Assigning goodwill to reporting units
- 5.4.50 Deferred tax assets and liabilities

Questions

- 5.4.10 How are assets (other than goodwill) and liabilities assigned to reporting units?
- 5.4.20 Can acquired assets (assumed liabilities) be assigned to preexisting reporting units?
- 5.4.30 Can some assets and liabilities remain unassigned when an entity has only one reporting unit?

- 5.4.40 How are 'corporate' assets and liabilities assigned to reporting units?
- 5.4.50 Are there different requirements for a reporting unit with a negative carrying amount?
- 5.4.60 Is corporate debt assigned to reporting units?
- 5.4.70 How is liability-classified contingent consideration assigned to reporting units?
- 5.4.80 Is equity-classified contingent consideration assigned to reporting units?
- 5.4.90 What are some of the factors to consider in allocating assets and liabilities to multiple reporting units?
- 5.4.100 How is goodwill assigned to reporting units?
- 5.4.110 Is the tax basis of goodwill assigned to reporting units and if so, how?
- 5.4.120 How is goodwill attributable to a foreign subsidiary considered in the impairment test?
- 5.4.130 How is goodwill reassigned when there is a reorganization or disposal?
- 5.4.140 How are deferred tax assets and liabilities that have financial statement bases assigned to reporting units?
- 5.4.150 How are deferred tax assets and liabilities that have no financial statement bases assigned to reporting units?
- 5.4.160 How are deferred tax asset valuation allowances assigned to reporting units?
- 5.4.170 Are liabilities for unrecognized tax benefits assigned to reporting units?
- 5.4.180 Are unrecognized deferred tax assets and liabilities assigned to reporting units?
- 5.4.190 What are the tax effects of goodwill remaining in a reporting unit on disposal of a business?

Examples

- 5.4.10 Assignment of assets and liabilities to reporting units
- 5.4.20 Allocating contingent consideration
- 5.4.30 Allocating an intangible asset when there are multiple reporting units
- 5.4.40 Foreign subsidiary goodwill
- 5.4.50 Allocating NOL carryforwards to reporting units
- 5.4.60 Remaining tax effects of goodwill when a business is disposed of

5.1 How the standards work

Determining a unit of account's carrying amount is critical to all three impairment models covered in this Handbook.

Qualitative assessment	Recoverability test	Measurement test
<p>Applies to:</p> <ul style="list-style-type: none"> — Indefinite-lived intangible assets — Goodwill 	<p>Applies to:</p> <ul style="list-style-type: none"> — Long-lived assets 	<p>Applies to:</p> <ul style="list-style-type: none"> — Indefinite-lived intangible assets — Long-lived assets — Goodwill
<p>Assess whether the carrying amount is more likely than not impaired.</p>	<p>Compare the carrying amount to the undiscounted estimated future cash flows.</p>	<p>Compare the carrying amount to the fair value.</p>
<p>See chapter 6</p>	<p>See chapter 7</p>	<p>See chapter 8</p>

This chapter discusses how the carrying amount is determined for each unit of account – indefinite-lived intangible assets, asset groups (for testing long-lived assets) and reporting units (for testing goodwill) – and whether there is any difference in the way the carrying amount is determined in applying the different tests.

This chapter refers to the following throughout:

- an indefinite-lived intangible asset, although the unit of account might be a grouping of such assets (see [section 3.2](#)); and
- an asset group, although the unit of account might be a single asset (see [section 3.3](#)).

5.2 Indefinite-lived intangible assets

The unit of account for testing indefinite-lived intangible assets is generally a single asset (see [section 3.2](#)). In the event that the unit of account comprises two or more intangible assets, the carrying amount of the unit of account is the aggregate carrying amount of the intangible assets in the unit.

Subsequently, the unit of account's carrying amount decreases due to:

- impairment losses
- removal of an indefinite-lived intangible from the unit of account.

5.3 Asset groups

The unit of account for long-lived asset impairment testing is the asset group (see [section 3.3](#)). Topic 360 contains limited guidance on the carrying amount of the unit of account. Instead, the focus is on applying the guidance on the composition of the cash flows in the Step 1 recoverability test (see [chapter 7](#)) to ensure that the comparison of the carrying amount with the future estimated cash flows is on a like-for-like basis. Therefore, this section focuses on the carrying amount of the asset group for purposes of the recoverability test.



Question 5.3.10

When is goodwill included in an asset group's carrying amount?

Interpretive response: As noted in [Question 3.3.10](#), if the asset group equals or includes a reporting unit, the associated goodwill of the reporting unit is included in the asset group for impairment testing. Goodwill is not included in the carrying amount of an asset group that represents only a part of a reporting unit. [360-10-35-26, 350-20-35-34]

See related [Question 7.4.100](#) that discusses the cash flows to include in the recoverability test.



Question 5.3.20

Are enterprise assets assigned to the underlying asset groups that they support?

Background: An enterprise asset is an asset that supports the revenue-producing activities of two or more asset groups. An example of an enterprise asset is a trade name that supports the revenue generated by various product groups. See [section 3.3.40](#).

Interpretive response: No. An entity does not assign the carrying amount of an enterprise asset to the carrying amounts of two or more lower-level asset groups. Instead, to test an enterprise asset for impairment, an additional higher-

level asset group is identified (see [Question 3.3.90](#)), which is tested for impairment after the related lower-level asset groups.

The carrying amount of the higher-level asset group depends on the approach taken to test the enterprise asset for recoverability, which is discussed in [Question 7.7.10](#). It will either be the carrying amount of the enterprise asset on its own (residual approach) or will include the carrying amounts of the related lower-level asset groups after those asset groups are tested for impairment and any impairment loss recognized.



Question 5.3.30

Are liabilities included in an asset group's carrying amount?

Interpretive response: It depends on the nature of the liability.

- Operating liabilities (e.g. accrued liabilities and accounts payable) are generally included in the carrying amount of the asset group. Exceptions arise for AROs (see [Question 5.3.60](#)) and operating lease liabilities recorded under Topic 842 (see [Question 5.3.40](#)).
- Nonoperating liabilities are generally excluded from the carrying amount of the asset group.

As an exception, a liability is included in an asset group's carrying amount if it is closely related to the group's assets – e.g. when the asset group is a reporting unit and the lowest level of identifiable cash flows includes principal payments on debt. In these cases, the payments of principal (not interest) are included in the cash flows to provide a like-for-like comparison.

As a result, including or excluding a liability and related cash flows should not result in a different conclusion in the recoverability test. However, if the liability is stated at a discounted amount, an adjustment may be required to ensure that the effect of discounting does not alter the outcome of the recoverability test.

See related [Question 7.4.20](#) that discusses the cash flows to include in the recoverability test.



Question 5.3.40

Does a lessee include lease liabilities in an asset group's carrying amount?

Background: The following are in the scope of Topic 360 (see [section 2.4](#)), and are therefore included in the carrying amount of the asset group:

- right-of-use assets (Topic 842)
- capital lease assets (Topic 840).

Interpretive response: Topic 842, a lessee excludes **finance lease** liabilities from the carrying amount of the asset group. Similarly, in applying Topic 840, capital lease obligations are not included in the carrying amount of the asset

group. This approach is consistent with the general principle in [Question 5.3.30](#) related to nonoperating debt.

We believe a lessee can elect either of the following approaches in performing the recoverability test for **operating leases** under Topic 842.

- **Approach A.** Exclude the carrying amount of the lease liability from the carrying amount of the asset group; and exclude the operating lease payments from the undiscounted future expected cash flows of the asset group. This approach is consistent with the requirements for AROs (see [Question 5.3.60](#)).
- **Approach B.** Include the carrying amount of the lease liability in the carrying amount of the asset group; and include the operating lease payments (net of the portion that relates to accretion of the operating lease liability) in the undiscounted future expected cash flows of the asset group.

In either case, the right-of-use asset is included in the carrying amount of the asset group.

These approaches are discussed in more depth in [Question 6.5.10](#) in KPMG Handbook, [Leases](#); this includes a demonstration that the outcome of the recoverability test should not be affected by the approach taken. Further, [Question 6.5.32](#) in KPMG Handbook, [Leases](#), discusses the implications of Approach B resulting in a negative carrying amount for the asset group.

See related [Question 7.4.30](#) that discusses the cash flows to include in the recoverability test.



Question 5.3.50

Is working capital included in an asset group's carrying amount?

Interpretive response: Yes. Working capital (e.g. inventory, trade receivables, trade payables) is included in the carrying amount of the asset group. This provides a like-for-like comparison between the carrying amount and the estimated future cash flows in the recoverability test. [360-10-55-21]



Question 5.3.60

Are AROs included in an asset group's carrying amount?



Excerpt from ASC 360-10

- > Assets Subject to Asset Retirement Obligations

35-18 In applying the provisions of this Subtopic, the carrying amount of the asset being tested for impairment shall include amounts of capitalized asset

retirement costs. Estimated future cash flows related to the liability for an asset retirement obligation that has been recognized in the financial statements shall be excluded from both of the following:

- a. The undiscounted cash flows used to test the asset for recoverability
- b. The discounted cash flows used to measure the asset's fair value.

35-19 If the fair value of the asset is based on a quoted market price and that price considers the costs that will be incurred in retiring that asset, the quoted market price shall be increased by the fair value of the asset retirement obligation for purposes of measuring impairment.

Background: When an entity initially recognizes a liability for an ARO, the corresponding amount is added to the carrying amount of the related long-lived asset. The liability is adjusted each period to reflect the passage of time (i.e. accretion expense) and any changes in the estimated future cash flows underlying the initial fair value measurement. [410-20-25-5, 35-1 – 35-8]

Interpretive response: No. While asset retirement costs capitalized to a long-lived asset are automatically included in the carrying amount of an asset group, Topic 360 specifically requires the cash outflows to be excluded from both the recoverability and measurement tests. Therefore, excluding the ARO from the carrying amount results in a like-for-like comparison. [360-10-35-18]



Question 5.3.70

Are pension obligations included in an asset group's carrying amount?

Interpretive response: No. As discussed in [Question 5.3.30](#), the asset group excludes nonoperating liabilities. Therefore, pension obligations are excluded from the carrying amount of the asset group. However, the service cost component of net periodic pension costs is included in the cash flows from operations.



Question 5.3.80

Is an accumulated CTA included in an asset group's carrying amount?



Excerpt from ASC 830-30

> Sale or Liquidation of an Investment in a Foreign Entity

40-1 Upon sale or upon complete or substantially complete liquidation of an investment in a **foreign entity**, the amount attributable to that entity and accumulated in the translation adjustment component of equity shall be both:

- a. Removed from the separate component of equity

b. Reported as part of the gain or loss on sale or liquidation of the investment for the period during which the sale or liquidation occurs.

• • > Consideration of Cumulative Translation Adjustment in Impairment Tests

45-14 ... paragraph 830-30-40-1 is clear that no basis exists to include the cumulative translation adjustment in an impairment assessment if that assessment does not contemplate a planned sale or liquidation that will cause reclassification of some amount of the cumulative translation adjustment. (If the reclassification will be a partial amount of the cumulative translation adjustment, this guidance contemplates only the cumulative translation adjustment amount subject to reclassification pursuant to paragraphs 830-30-40-2 through 40-4.).

Interpretive response: No. An entity does not include the CTA as part of the carrying amount of its investment in the foreign subsidiary when evaluating the investment (asset group) for impairment under a held-and-used model. [830-30-45-14]

The CTA is included in the carrying amount of the investment when the entity is committed to a plan of disposal that will cause the CTA to be reclassified from accumulated OCI and reported in the income statement. We believe that whether management is committed to a plan of disposal should be based on the criteria to classify an asset (disposal group) as held-for-sale. See chapter 4 of KPMG Handbook, [Discontinued operations and held-for-sale disposal groups](#).

[Question 7.2.60](#) discusses the cash flows to include in the recoverability test when a subsidiary's functional currency differs from that of the parent.



Question 5.3.90

How does a hedged forecasted transaction affect the carrying amount of an asset group?

Interpretive response: We believe neither the fair value (or the expected cash flows) of the related derivative hedging instrument nor any derivative gain or loss in AOCI associated with the hedged forecasted transaction (e.g. forecasted sales of inventory) should affect the carrying amount of the asset group; this means that the carrying amount of the hedging instrument and related amounts in AOCI should be excluded from the asset group as if the hedging transaction did not exist. This approach allows a like-for-like comparison because Topic 815 (derivatives and hedging) requires the expected cash flows to be excluded from the impairment testing.

However, in certain situations, it may be necessary to reclassify certain amounts from AOCI into earnings when considering the combination of the hedged forecasted transaction and the amount in AOCI. See section 10.4 of KPMG Handbook, [Derivatives and hedging](#).

5.4 Reporting units

5.4.10 Overview



Excerpt from ASC 350-20

> Assigning Acquired Assets and Assumed Liabilities to a Reporting Unit

35-39 For the purpose of testing goodwill for impairment, acquired assets and assumed liabilities shall be assigned to a reporting unit as of the acquisition date if both of the following criteria are met:

- a. The asset will be employed in or the liability relates to the operations of a reporting unit.
- b. The asset or liability will be considered in determining the fair value of the reporting unit.

Assets or liabilities that an entity considers part of its corporate assets or liabilities shall also be assigned to a reporting unit if both of the preceding criteria are met. Examples of corporate items that may meet those criteria and therefore would be assigned to a reporting unit are environmental liabilities that relate to an existing operating facility of the reporting unit and a pension obligation that would be included in the determination of the fair value of the reporting unit. This provision applies to assets acquired and liabilities assumed in a business combination and to those acquired or assumed individually or with a group of other assets.



Question 5.4.10

How are assets (other than goodwill) and liabilities assigned to reporting units?

Interpretive response: Although a reporting unit is a business (see [section 3.4.20](#)), not all of the assets and liabilities that the entity might associate with the reporting unit are necessarily assigned to it for impairment testing purposes. Only assets and liabilities that meet the following criteria are assigned to a reporting unit: [\[350-20-35-39\]](#)

- the asset will be employed in, or the liability relates to, a reporting unit's operations; and
- the asset or liability will be considered in determining a reporting unit's fair value.

The objective of the assignment process is to ensure that the assets and liabilities assigned to the carrying amount of a reporting unit are the same net assets that will generate the cash flows considered in determining the fair value of that unit.

The following decision tree illustrates the process of allocating assets and liabilities. [\[350-20-35-39 – 35-40\]](#)

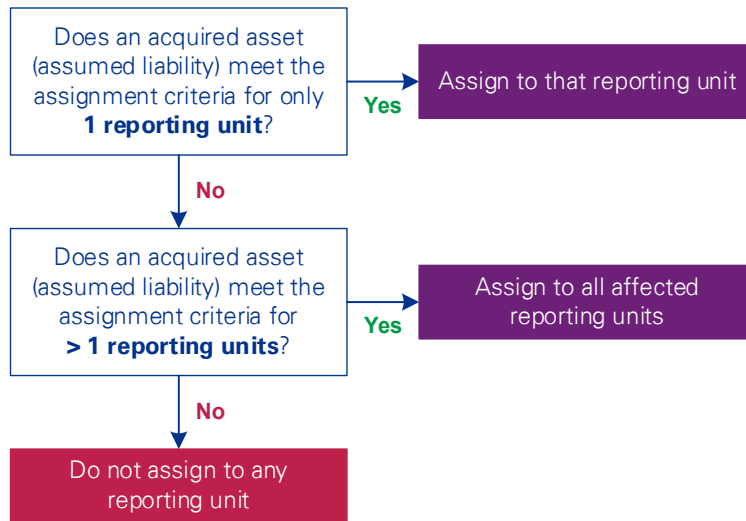

The assignment of assets and liabilities under Subtopic 350-20 is for impairment testing purposes only. Absent an impairment loss, the cost bases of the underlying assets are not adjusted. [350-20-35-39]

Assets and liabilities that do not meet the above criteria are not assigned to any reporting unit. Such items might include corporate headquarters, certain administrative departments and corporate debt.



Question 5.4.20

Can acquired assets (assumed liabilities) be assigned to preexisting reporting units?

Interpretive response: Yes. The objective of the assignment process is to ensure that the assets and liabilities assigned to a reporting unit's carrying amount are the same net assets that will generate the cash flows considered in determining the unit's fair value (see [Question 5.4.10](#)). Therefore, reporting units to which acquired assets and assumed liabilities are assigned include both the acquirer's preexisting reporting units, and newly constituted reporting units as a result of the acquisition.



Example 5.4.10

Assignment of assets and liabilities to reporting units

Retailer has two reporting units, RU-A and RU-B, each representing a different product line. Retailer buys a competitor that sells the same products as RU-A and RU-B for total consideration of \$100 million. The fair value of the identifiable net assets acquired is \$70 million.

Scenario 1: Competitor's brand discontinued

Retailer does not intend to maintain Competitor's brand and does not create a new reporting unit. Therefore, Retailer assigns all identifiable net assets acquired to the existing reporting units: \$50 million is assigned to RU-A, and \$20 million to RU-B.

Scenario 2: Competitor's brand continued

Retailer intends to maintain Competitor's brand by continuing to operate the acquired stores under Competitor's name. Retailer determines that the acquired business forms a new reporting unit, RU-C. Therefore, Retailer assigns the entire \$70 million of identifiable net assets to RU-C.



Question 5.4.30

Can some assets and liabilities remain unassigned when an entity has only one reporting unit?

Interpretive response: If an entity consists of only a single reporting unit, the issue is whether there are certain corporate assets and liabilities that do not relate to the operations of the reporting unit and should therefore be excluded from the reporting unit.

There is no explicit guidance on assigning assets and liabilities when an entity has only one reporting unit, and the EITF has explicitly declined to mandate an approach. [ASU 2010-28.BC4]

Accordingly, if an entity uses the enterprise premise to measure the fair value of the reporting unit (see [section 8.3.20](#)), it would not necessarily assign all liabilities when determining the carrying amount of its reporting unit. Attempts to reconcile the reporting unit's fair value to market capitalization will be complicated in these cases because the share price most likely accounts for the entity's complete balance sheet.

In addition, an entity should consider whether the criteria have been met when assigning assets and liabilities to its single reporting unit (see [Question 5.4.10](#)) and determine that the assets and liabilities have been assigned in a consistent manner both for determining the carrying amount and measuring fair value.



Question 5.4.40

How are 'corporate' assets and liabilities assigned to reporting units?

Interpretive response: Corporate assets (and liabilities) are not defined in the Codification, but Subtopic 350-20 gives the examples of environmental liabilities that relate to an existing operating facility of the reporting unit and a pension obligation that would be included in measuring the reporting unit's fair value. [350-20-35-39]

Corporate assets (and liabilities) are assigned to one or more reporting units if the assignment criteria are met (see [Question 5.4.10](#)). In many cases, they will remain unassigned (see [section 5.4.30](#)). [350-20-35-39 – 35-40]

Note: A corporate asset in applying Subtopic 350-20 is not the same as an enterprise asset in applying Topic 360. As discussed in [section 3.3.40](#), an enterprise asset is an asset that supports the revenue-producing activities of two or more asset groups – e.g. a trade name that supports the revenue generated by various product groups. It might also be called a corporate-support asset. Enterprise assets are not assigned to multiple asset groups. Instead, an additional asset group is identified at the level of the enterprise asset (see [Question 3.3.90](#)).



Question 5.4.50

Are there different requirements for a reporting unit with a negative carrying amount?

Interpretive response: No. Entities test reporting units with zero or negative carrying amounts in the same manner as other reporting units. Following the adoption of ASU 2017-04 (see [Appendix A](#)), there are no ‘special’ requirements for such reporting units. [350-20-50-1A]

However, the valuation premise used to measure fair value may affect the outcome of the quantitative test in certain circumstances; see discussion in [Question 8.3.40](#).

5.4.20 Allocating liabilities to reporting units

Liabilities of the entity are assigned to reporting units following the same general principles as assets. However, certain liabilities give rise to more questions because the obligor (and any guarantor) and the funding source for repayments may be in different reporting units.



Question 5.4.60

Is corporate debt assigned to reporting units?

Interpretive response: It depends on the valuation premise used in valuing the reporting unit, which is discussed in [section 8.3.20](#). In particular, [Question 8.3.50](#) discusses the carrying amount of the reporting unit that corresponds to each valuation premise to ensure a like-for-like comparison in the impairment testing.



Question 5.4.70

How is liability-classified contingent consideration assigned to reporting units?

Background: Contingent consideration issued by an acquirer in a business combination is recognized at its acquisition-date fair value and classified at the acquisition date as either equity or as a liability (or in some cases an asset). As such, it affects the determination of goodwill arising in the acquisition.

The subsequent accounting for contingent consideration depends on whether the obligation is classified as equity or as a liability (or asset). The accounting is discussed in KPMG Handbook, [Business combinations](#), section 6 (consideration transferred) and section 12 (subsequent measurement and accounting).

Interpretive response: If the contingent consideration is owed by an entity that is included in a reporting unit containing the acquired business that gave rise to the obligation, the contingent consideration liability is generally assigned to that reporting unit. In other, more complex scenarios – e.g. the parent is the obligor for the contingent consideration, or the acquirer and acquiree are assigned to different reporting units – assignment may depend on how the payments will be funded and the effect on the fair value of the various reporting units.

However, liability-classified contingent consideration is measured at fair value at each reporting period date, until the contingency is resolved. Therefore, if a discounted cash flow technique is used to measure the fair value of the reporting unit (see [section 8.3.50](#)), the cash outflows will also be at fair value and the impairment test is generally not affected by including or excluding the contingent consideration; in practice, the fair value of the contingent consideration is typically deducted from the net present value of the cash flows to arrive at the fair value of the reporting unit.

Note: The decision of whether to assign a contingent consideration liability to one or more reporting units does not affect the amount of goodwill assigned to those units. In effect, assigning the contingent consideration liability offsets the assignment of goodwill, which increases the ‘equity’ in the reporting unit.



Example 5.4.20

Allocating contingent consideration

Parent has three subsidiaries (Sub A, Sub B and Sub C) that each comprise a separate reporting unit (RU-A, RU-B and RU-C, respectively). Sub C acquires Sub D.

The assets and liabilities of the acquired business (Sub D) are all assigned to RU-C.

The terms of the acquisition agreement provide for contingent consideration to be paid in cash by Sub C two years after the acquisition date if specified earnings targets are met.

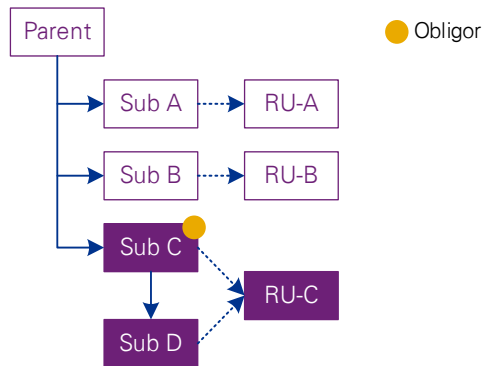

Parent assigns the contingent consideration liability to RU-C for the following reasons.

- The obligation to pay contingent consideration is owed by Sub C, which is included in the same reporting unit as the acquired business that gave rise to the obligation (RU-C).
- Sub C’s obligation to pay contingent consideration is related to the operations of RU-C because those payments are based on the achievement of Sub-D’s earnings targets.
- Sub C’s payment of the contingent consideration will reduce the net cash flows of RU-C, which in turn reduces the fair value of RU-C.

Question 5.4.80
Is equity-classified contingent consideration assigned to reporting units?

Interpretive response: No. The net carrying amount of a reporting unit is determined by subtracting its liabilities from its assets. That net carrying amount is not adjusted for the carrying amount of equity-classified contracts entered into by entities within the reporting unit; this includes equity-classified contingent consideration arrangements.

5.4.30 Allocating assets (other than goodwill) and liabilities to multiple reporting units

Excerpt from ASC 350-20

> Assigning Acquired Assets and Assumed Liabilities to a Reporting Unit

35-40 Some assets or liabilities may be employed in or relate to the operations of multiple reporting units. The methodology used to determine the amount of those assets or liabilities to assign to a reporting unit shall be reasonable and supportable and shall be applied in a consistent manner. For example, assets

and liabilities not directly related to a specific reporting unit, but from which the reporting unit benefits, could be assigned according to the benefit received by the different reporting units (or based on the relative fair values of the different reporting units). In the case of pension items, for example, a pro rata assignment based on payroll expense might be used. A reasonable allocation method may be very general. For use in making those assignments, the basis for and method of determining the fair value of the acquiree and other related factors (such as the underlying reasons for the acquisition and management's expectations related to dilution, synergies, and other financial measurements) shall be documented at the acquisition date.

Items that may have to be assigned to multiple reporting units if the assignment criteria are met include:

- tangible assets – e.g. corporate aircraft, shared facilities, equipment;
- intangible assets – e.g. trademarks, permits, customer lists;
- liabilities – e.g. debt, employee-related liabilities; and
- functional departments – e.g. internal audit, risk management, marketing, treasury, in-house travel, human resources.



Question 5.4.90

What are some of the factors to consider in allocating assets and liabilities to multiple reporting units?

Interpretive response: The methodology used to assign assets and liabilities to reporting units should be reasonable and supportable and should be applied in a consistent manner. Although Subtopic 350-20 acknowledges that a reasonable assignment method may be very general, an entity should not underestimate the complexity of assigning assets and liabilities to reporting units. [350-20-35-40]

A key factor to consider is how a disposal transaction (based on market participant assumptions) would be structured. [Example 5.4.30](#) explores common assignment methods for a trademark that is relevant to the operations of two reporting units.

Assets and liabilities not directly related to a specific reporting unit, but from which the reporting unit benefits, could be assigned according to the benefit received by the different reporting units, or based on the relative fair values of the different reporting units. In the case of pension items, a pro rata assignment based on payroll expense may be appropriate or using headcount or another measure of plan participants. The chosen method should reflect the relative benefit of those pension items to each reporting unit.

Areas that may prove to be especially challenging to assign include:

- corporate-level treasury or cash management functions – e.g. some retailers move store-level cash receipts into a single account each day to maximize cash management; and
- indebtedness incurred at the corporate level that is used to finance, or finance the acquisition of, subsidiary-level businesses.

Factors relevant to the methodology – e.g. the basis and method of determining the fair value of the acquiree – must be documented at the date of acquisition.
 [350-20-35-40]



Example 5.4.30

Allocating an intangible asset when there are multiple reporting units

This example is based on part of Example 2-3 in the AICPA Audit & Accounting Guide, Testing Goodwill for Impairment.

ABC Corp. owns a trademark that was acquired through a business combination several years ago. The trademark is recorded at the corporate level and benefits two of ABC's reporting units: RU-A and RU-B. This example explores common assignment methods for a trademark that is relevant to the operations of two reporting units.

Scenario 1: Assign based on assumed transfer of the trademark

In this scenario, ABC concludes that it would transfer the rights to the trademark to RU-A in a hypothetical disposal because RU-A is the primary user of the trademark. Therefore, ABC assigns the carrying amount of the trademark to RU-A.

Consistently, the fair value of RU-A includes any expenses associated with the continuing support and maintenance of the trademark (e.g. brand marketing expenses) and the royalty income expected to be received from RU-B for the continued use of the trademark. Conversely, the fair value of RU-B includes the corresponding cash outflows associated with the royalty fee paid to RU-A. See [section 8.5](#).

Scenario 2: Assign based on assumed rental of the trademark

In this scenario, ABC concludes that it would not include the rights to the trademark in a hypothetical disposal of either of the reporting units. Instead, ABC would retain control of the trademark and allow its continued use for a revenue-based royalty fee. Therefore, ABC does not assign any portion of the carrying amount of the trademark to RU-A or RU-B (entity Question 5.4.30).

Consistently, RU-A and RU-B include in the cash outflows used to measure their fair values the estimated royalty expense (at market terms) that each would pay ABC for continued use of the trademark. See [section 8.5](#).

5.4.40 Assigning goodwill to reporting units



Excerpt from ASC 350-20

> Assigning Goodwill to Reporting Units

35-41 For the purpose of testing goodwill for impairment, all goodwill acquired

in a business combination shall be assigned to one or more reporting units as of the acquisition date. Goodwill shall be assigned to reporting units of the acquiring entity that are expected to benefit from the synergies of the combination even though other assets or liabilities of the acquired entity may not be assigned to that reporting unit. The total amount of acquired goodwill may be divided among a number of reporting units. The methodology used to determine the amount of goodwill to assign to a reporting unit shall be reasonable and supportable and shall be applied in a consistent manner. In addition, that methodology shall be consistent with the objectives of the process of assigning goodwill to reporting units described in paragraphs 350-20-35-42 through 43.

35-42 In concept, the amount of goodwill assigned to a reporting unit would be determined in a manner similar to how the amount of goodwill recognized in a business combination is determined. That is:

- a. An entity would determine the fair value of the acquired business (or portion thereof) to be included in a reporting unit—the fair value of the individual assets acquired and liabilities assumed that are assigned to the reporting unit. Subtopic 805-20 provides guidance on assigning the fair value of the acquiree to the assets acquired and liabilities assumed in a business combination.
- b. Any excess of the fair value of the acquired business (or portion thereof) over the fair value of the individual assets acquired and liabilities assumed that are assigned to the reporting unit is the amount of goodwill assigned to that reporting unit.

35-43 If goodwill is to be assigned to a reporting unit that has not been assigned any of the assets acquired or liabilities assumed in that acquisition, the amount of goodwill to be assigned to that unit might be determined by applying a with-and-without computation. That is, the difference between the fair value of that reporting unit before the acquisition and its fair value after the acquisition represents the amount of goodwill to be assigned to that reporting unit.

35-44 This Subtopic does not require that goodwill and all other related assets and liabilities assigned to reporting units for purposes of testing goodwill for impairment be reflected in the entity's reported segments. However, even though an asset may not be included in reported segment assets, the asset (or liability) shall be allocated to a reporting unit for purposes of testing for impairment if it meets the criteria in paragraph 350-20-35-39.

> Reorganization of Reporting Structure

35-45 When an entity reorganizes its reporting structure in a manner that changes the composition of one or more of its reporting units, the guidance in paragraphs 350-20-35-39 through 35-40 shall be used to reassign assets and liabilities to the reporting units affected. However, goodwill shall be reassigned to the reporting units affected using a relative fair value allocation approach similar to that used when a portion of a reporting unit is to be disposed of (see paragraphs 350-20-40-1 through 40-7).

35-46 For example, if existing reporting unit A is to be integrated with reporting units B, C, and D, goodwill in reporting unit A would be assigned to units B, C, and D based on the relative fair values of the three portions of reporting unit A

prior to those portions being integrated with reporting units B, C, and D.

• • > Goodwill Impairment Testing and Disposal of All or a Portion of a Reporting Unit When the Reporting Unit Is Less Than Wholly Owned

35-57A If a reporting unit is less than wholly owned, the fair value of the reporting unit as a whole shall be determined in accordance with paragraphs 350-20-35-22 through 35-24, including any portion attributed to the noncontrolling interest. Any impairment loss measured in the goodwill impairment test shall be attributed to the parent and the **noncontrolling interest** on a rational basis. If the reporting unit includes only goodwill attributable to the parent, the goodwill impairment loss would be attributed entirely to the parent. However, if the reporting unit includes goodwill attributable to both the parent and the noncontrolling interest, the goodwill impairment loss shall be attributed to both the parent and the noncontrolling interest.

35-57B If all or a portion of a less-than-wholly-owned reporting unit is disposed of, the gain or loss on disposal shall be attributed to the parent and the noncontrolling interest.

> Disposal of All or a Portion of a Reporting Unit

40-1 When a reporting unit is to be disposed of in its entirety, goodwill of that reporting unit shall be included in the carrying amount of the reporting unit in determining the gain or loss on disposal.

40-2 When a portion of a reporting unit that constitutes a business (see Section 805-10-55) or nonprofit activity is to be disposed of, goodwill associated with that business or nonprofit activity shall be included in the carrying amount of the business or nonprofit activity in determining the gain or loss on disposal.

40-3 The amount of goodwill to be included in that carrying amount shall be based on the relative fair values of the business or nonprofit activity to be disposed of and the portion of the reporting unit that will be retained. For example, if a reporting unit with a fair value of \$400 is selling a business or nonprofit activity for \$100 and the fair value of the reporting unit excluding the business or nonprofit activity being sold is \$300, 25 percent of the goodwill residing in the reporting unit would be included in the carrying amount of the business or nonprofit activity to be sold.

40-4 However, if the business or nonprofit activity to be disposed of was never integrated into the reporting unit after its acquisition and thus the benefits of the acquired goodwill were never realized by the rest of the reporting unit, the current carrying amount of that acquired goodwill shall be included in the carrying amount of the business or nonprofit activity to be disposed of.

40-5 That situation might occur when the acquired business or nonprofit activity is operated as a standalone entity or when the business or nonprofit activity is to be disposed of shortly after it is acquired.

40-6 Situations in which the acquired business or nonprofit activity is operated as a standalone entity are expected to be infrequent because some amount of integration generally occurs after an acquisition.

40-7 When only a portion of goodwill is allocated to a business or nonprofit

activity to be disposed of, the goodwill remaining in the portion of the reporting unit to be retained shall be tested for impairment in accordance with paragraphs 350-20-35-3A through 35-13 using its adjusted carrying amount.

Goodwill is assigned to the reporting units that are expected to benefit from expected synergies of the business combination, even if the acquired assets and assumed liabilities are not assigned to that reporting unit. All goodwill must be assigned to one or more reporting units – there are no exceptions. [350-20-35-41]

Question 5.4.100
How is goodwill assigned to reporting units?

Interpretive response: There is no required methodology for allocating goodwill to reporting units. However, similar to the assignment of other assets and liabilities, the methodology for allocating goodwill should be reasonable and supportable and should be applied in a consistent manner; further, the method applied should not result in an immediate goodwill impairment loss. [350-20-35-41]

The acquisition and with-and-without methods discussed below are the most commonly applied in practice.

Acquisition method

The acquisition method is generally appropriate when a reporting unit is expected to benefit from the synergies of the combination and at least some portion of the acquired business is assigned to that reporting unit. [350-20-35-42]

This method is similar to the approach followed in a business combination. As illustrated in the diagram, the fair value of the assigned portion of the business is compared to the aggregate fair values of the individual assets and liabilities assigned to that reporting unit. [350-20-35-42]



With-and-without method

The with-and-without method is generally appropriate when a reporting unit is expected to benefit from market participant synergies – meaning synergies that have been paid for and are included in the purchase consideration – of the combination but none of the individual assets and liabilities acquired have been assigned to that reporting unit. As illustrated in the diagram, the difference in the fair value of the reporting unit before and after the acquisition is the basis for allocating goodwill. [350-20-35-43]



This method can be complex if more synergies are created in the acquisition than were paid for. In that case, the acquisition method may be more appropriate.

Goodwill relates to whole entity

In some cases, goodwill might relate to the entity as a whole instead of to specific reporting units. This might be the case if the goodwill arises from pushdown accounting under Topic 805 (business combinations) or fresh-start reporting under Subtopic 852-10 (reorganizations).

In that case, possible methods of allocating goodwill include:

- based on the relative excesses of the fair values of the reporting units over the carrying amounts (fair value) of the individual assets and liabilities assigned to them; or
- based on the relative fair values of the reporting units.



Question 5.4.110

Is the tax basis of goodwill assigned to reporting units and if so, how?

Interpretive response: Yes. The method used to assign the tax basis of goodwill among multiple reporting units should be consistent with the method used to assign the financial statement carrying amount of goodwill (see [Question 5.4.100](#)).

For example, total goodwill is \$30 million – \$20 million is assigned to RU-A, and \$10 million to RU-B. In that case, two-thirds of the tax basis of the goodwill should be assigned to RU-A, and one third to RU-B.

If reporting units are in multiple jurisdictions, or if within a reporting unit there are separate legal entities filing separate tax returns within one jurisdiction, the tax basis of goodwill should be determined separately for each tax-paying component in each tax jurisdiction. For additional discussion, see paragraph 10.028 of KPMG Handbook, [Accounting for income taxes](#).



Excerpt from ASC 350-20

> Assigning Acquired Assets and Assumed Liabilities to a Reporting Unit

35-39A Foreign currency translation adjustments should not be allocated to a reporting unit from an entity's accumulated other comprehensive income. The

reporting unit's carrying amount should include only the currently translated balances of the assets and liabilities assigned to the reporting unit.



Question 5.4.120

How is goodwill attributable to a foreign subsidiary considered in the impairment test?

Background: A foreign entity is an operation (e.g. subsidiary, division, branch, joint venture) whose financial statements are: [\[Master Glossary\]](#)

- prepared in a currency other than the reporting currency of the reporting entity; and
- combined or consolidated in the financial statements of the reporting entity, or accounted for using the equity method.

Interpretive response: Goodwill and other acquisition adjustments of a foreign subsidiary represent assets and liabilities of the acquired foreign entity. This is the case even if pushdown accounting is not applied – see section 22 of KPMG Handbook, [Business combinations](#).

Therefore, such amounts are measured in the functional currency of the acquiree; if that functional currency is a foreign currency (i.e. different from the reporting currency), they are translated at current exchange rates in the acquirer's consolidated financial statements. As a consequence, this translation will affect the cumulative translation adjustment in the acquirer's financial statements. [\[830-10-15-6, 830-30-45-11\]](#)

There is no specific guidance on how to assign goodwill to an acquiree's entities. We believe goodwill should be attributed to all the acquiree's entities (both foreign and domestic) that contain one or more businesses. Conversely, we believe goodwill should not be attributed to an entity that does not contain a business (e.g. a holding company with no operations). The definition of a business is discussed in section 2 of KPMG Handbook, [Business combinations](#).

In the absence of specific guidance, when allocating goodwill to the acquiree's entities that contain businesses, we believe it is appropriate to analogize to the guidance on assigning goodwill to reporting units (see [Question 5.4.100](#)).

For impairment testing purposes, the goodwill assigned to one or more reporting units is the amount translated at the current exchange rate. The amount recognized in the cumulative translation adjustment is not included in the carrying amount(s) of the reporting unit(s). [\[350-20-35-39A\]](#)

For additional discussion on translation of foreign currency financial statements, see section 4 of KPMG Handbook, [Foreign currency](#).



Example 5.4.40 Foreign subsidiary goodwill

On February 1, Parent, which uses the US dollar as its reporting currency, acquired a London-based entity (Foreign Sub) whose functional currency is British pounds.

On acquisition, Parent recognized goodwill of \$1,000 (£700 equivalent) in its consolidated financial statements. Parent assigned the acquired goodwill to the three reporting units of Foreign Sub as follows.

Goodwill assigned	RU-A	RU-B	RU-C	Total
In British pounds	£ 350	£ 250	£ 100	£ 700
Translated to US\$	\$ 500	\$ 357	\$ 143	\$1,000

On November 30 that year, Parent is testing goodwill for impairment. Parent translates the goodwill assigned to the three reporting units and recognizes the effect of conversion in OCI as a CTA as follows.

Goodwill assigned (Rounded)	RU F1	RU F2	RU F3	Total
In British pounds	£ 350	£ 250	£ 100	£ 700
Translated to US\$ at Feb 1	\$ 500	\$ 357	\$ 143	\$1,000
Translated to US\$ on Nov 30	437	313	125	875
Debit to OCI (CTA)	\$ 63	\$ 44	\$ 18	\$ 125

The carrying amounts of the goodwill used in the impairment testing at November 30 are the amounts translated at that date (i.e. a total of \$875). The cumulative translation adjustment in OCI is not included in the carrying amount of the reporting unit.



Question 5.4.130 How is goodwill reassigned when there is a reorganization or disposal?

Interpretive response: When goodwill needs to be reassigned following a reorganization or for purposes of accounting for a disposal, it is generally done using relative fair values. [350-20-35-45 – 35-46, 40-3]

For example, if a business is being sold for \$100 and the fair value of the reporting unit excluding the business being sold is \$300, then 25% ($\$100 / (\$100 + \$300)$) of the goodwill residing in the reporting unit is included in the carrying amount of the business to be sold.

The following are exceptions that apply when there is a disposal: [350-20-35-45 – 35-46, 40-1 – 40-6]

- If the business being disposed of was operated as a stand-alone entity or is to be disposed of shortly after acquisition (i.e. was never integrated into the reporting unit), the entire carrying amount of the goodwill related to that business is included in the carrying amount of the disposed business.
- If the portion being disposed of does not constitute a business, goodwill is not assigned.

If only a portion of a reporting unit is disposed of, the goodwill associated with the remainder of the reporting unit is evaluated for impairment. If the goodwill associated with the remainder of the reporting unit is impaired, any impairment loss is presented separately in the income statement and is not subsumed into the gain or loss on disposal. [350-20-40-7]

Section 9.4.20 discusses how an impairment loss is allocated to the components of goodwill for tax purposes. First and second component goodwill is determined in the acquisition accounting and is not subsequently reevaluated. Therefore, when all or a portion of a reporting unit is sold, the entity follows the same accounting as when goodwill is reduced as a result of impairment.

If the reporting unit includes goodwill attributable to a parent in a less-than-wholly owned subsidiary acquired before the adoption of Topic 805 (business combinations) and Subtopic 810-10 (consolidation), any impairment loss is attributed entirely to the parent. [350-20-35-57A – 35-57B]

5.4.50 Deferred tax assets and liabilities



Excerpt from ASC 350-20

> Recognition and Measurement of an Impairment Loss

• > Qualitative Assessment

35-7 In determining the carrying amount of a reporting unit, deferred income taxes shall be included in the carrying amount of the reporting unit, regardless of whether the fair value of the reporting unit will be determined assuming it would be bought or sold in a taxable or nontaxable transaction.

How a deferred tax asset or liability is assigned to a reporting unit depends on whether it has a corresponding financial statement carrying amount. The tax basis of a deferred tax asset or liability has a corresponding financial statement carrying amount if the deferred tax asset or liability relates to an asset or liability recognized on the balance sheet. An example of a deferred tax asset that does not have a corresponding financial statement carrying amount is an NOL carryforward.



Question 5.4.140

How are deferred tax assets and liabilities that have financial statement bases assigned to reporting units?

Interpretive response: Deferred tax assets and liabilities that relate to the assets and liabilities assigned to a reporting unit – meaning they have financial statement bases – are also assigned to that reporting unit. [350-20-35-7]

The method used to assign deferred taxes to reporting units should be consistent with how the related asset or liability is assigned (see [section 5.4.10](#)). For example, if a production facility is included in a reporting unit, any related deferred tax asset or liability is included in the reporting unit.

This assignment is made even if the deferred tax asset or liability will not be considered in determining the reporting unit’s fair value. This follows the specific requirement in Subtopic 350-20, which overrides the general assignment principles in [Question 5.4.10](#). [350-20-35-7]

Certain deferred tax assets and liabilities may relate to assets and liabilities that have been assigned to multiple reporting units (see [section 5.4.30](#)). In that case, the deferred taxes should be assigned to those reporting units on the same basis as the related assets or liabilities were assigned. For example, a deferred tax asset for vacation pay accruals that relates to all of the entity’s employees should be assigned to the reporting units in which the employees provide services, consistent with the method used to assign the vacation pay liability to reporting units.

The deferred taxes related to assets and liabilities not assigned to a reporting unit likewise should not be assigned to a reporting unit. For example, if an environmental liability related to a disposed business is not assigned to a reporting unit (see [Question 5.4.10](#)), then the related deferred tax is also not assigned.



Question 5.4.150

How are deferred tax assets and liabilities that have no financial statement bases assigned to reporting units?

Interpretive response: Deferred tax assets and liabilities that exist because of a tax basis that has no corresponding financial statement carrying amount (e.g. NOL carryforwards) should be assigned to one or more reporting units if the general assignment principles in [Question 5.4.10](#) are met:

- the deferred tax asset or liability relates to the operations of the reporting unit; and
- it will be considered in determining the fair value of the reporting unit.

For example, if the deferred tax assets related to NOL carryforwards and credit carryforwards that arise from the operations of a reporting unit are considered by market participants when determining the fair value of the reporting unit,

those deferred tax assets should be assigned to the reporting unit. However, in many cases NOL carryforwards are not reflected in the fair value of a reporting unit that is measured assuming a taxable transaction; therefore, they will not be included in the carrying amount of the reporting unit. [Example 5.4.50](#) provides a simple example, and [section 8.3.30](#) discusses taxable versus nontaxable transactions in more depth.

Allocating NOL carryforwards to reporting units is a straightforward process when the carryforward is generated solely from the operations of a particular reporting unit – e.g. when the reporting unit is a consolidated subsidiary for financial reporting purposes but files its own tax return. However, in most situations the assignment process will be more difficult, especially when a reporting unit is a component of a group that files a consolidated tax return.

The method used to assign the deferred tax assets to reporting units should be reasonable and systematic. An approach similar to that used for intercorporate tax allocation is one method that may be appropriate. See section 10 of KPMG Handbook, [Accounting for income taxes](#), for additional acceptable methods for intercorporate tax allocation.



Example 5.4.50

Allocating NOL carryforwards to reporting units

ABC Corp. is testing Reporting Unit for impairment.

The carrying amount of the assets and liabilities of Reporting Unit are:

- Identifiable assets, \$500
- Identifiable liabilities, \$200
- Goodwill, \$450.

Further, there is a deferred tax asset associated with an NOL carryforward of \$75. In applying the quantitative goodwill impairment test, ABC considers whether Reporting Unit would be sold in a taxable or nontaxable transaction with a market participant.

Scenario 1: Taxable transaction

ABC concludes that a nontaxable transaction is not feasible, in part because several reporting units are contained in a single legal entity. As a result, it concludes that a sale of the reporting unit would be structured as a taxable transaction.

In a taxable transaction, NOL carryforwards are not available to an acquirer and would not be reflected in the fair value of a reporting unit. For this reason, ABC does not assign deferred tax assets related to NOL carryforwards to the carrying amount of Reporting Unit.

Therefore, the carrying amount of Reporting Unit is \$750: identifiable assets of \$500 + goodwill of \$450 - identifiable liabilities of \$200.

Scenario 2: Nontaxable transaction

ABC concludes that Reporting Unit's value would be maximized through a nontaxable transaction and that it is feasible to sell Reporting Unit in a

nontaxable transaction. For this reason, the fair value of Reporting Unit includes the value of the tax benefit attributable to the NOL carryforward.

Therefore, the carrying amount of Reporting Unit is \$825: \$750 from Scenario 1 + deferred tax asset of \$75.



Question 5.4.160

How are deferred tax asset valuation allowances assigned to reporting units?

Interpretive response: In principle, a deferred tax asset valuation allowance that is recognized for a specific deferred tax asset should be assigned to the reporting unit to which the specific deferred tax asset is assigned. However, valuation allowances are frequently not asset-specific.

For example, an entity concludes that its only source of taxable income to support realization of its deferred tax assets is the reversal of existing taxable temporary differences. As a result, it recognizes a valuation allowance equal to the amount of its deferred tax assets that are not supported by the reversal of its deferred tax liabilities. The entity is not able to associate the valuation allowance with specific deferred tax assets. In this case, the valuation allowance should be assigned to deferred tax assets before allocating the deferred tax assets to the reporting units.

Various methods may be appropriate in making that assignment, depending on facts and circumstances. For example, the valuation allowance could be assigned on a pro rata basis to all deferred tax assets. It may also be acceptable for an entity to assign the valuation allowance based on which deferred tax assets are more likely than not of being realized based on the entity's scheduling.



Question 5.4.170

Are liabilities for unrecognized tax benefits assigned to reporting units?

Interpretive response: Yes. Liabilities recognized for unrecognized tax benefits associated with a reporting unit should be assigned to that reporting unit. This assignment should be performed in a manner consistent with the entity's assignment methodology for other current and deferred tax items (see [Questions 5.4.140](#) and [5.4.150](#)).



Question 5.4.180

Are unrecognized deferred tax assets and liabilities assigned to reporting units?

Background: Certain deferred tax assets and liabilities are not recognized in the financial statements. For example, they may not be recognized because they:

- are subject to specific exceptions in Topic 740 – see section 2 of KPMG Handbook, [Accounting for income taxes](#);
- do not meet the recognition criteria – i.e. they are not more likely than not to be sustained based on their technical merits; or
- are a deductible temporary difference related to an investment in a subsidiary.

Interpretive response: No. Deferred tax assets and liabilities that have not been recognized in the financial statements should not be included in the carrying amount of a reporting unit. This is because unrecognized assets and liabilities are neither employed in nor related to the operations of a reporting unit as reported in the financial statements.



Question 5.4.190

What are the tax effects of goodwill remaining in a reporting unit on disposal of a business?

Interpretive response: On the disposal of a business within a larger reporting unit, the seller generally allocates the reporting unit's goodwill between the business that was disposed of, and the remaining parts of the reporting unit based on their relative fair values on the date of disposal (see [Question 5.4.130](#)).

For tax purposes, the gain or loss considers specific tax goodwill associated with the disposed entity. We believe first and second component goodwill is determined in the acquisition accounting and is not subsequently reevaluated. Consequently, the goodwill that leaves the reporting unit will retain its acquisition date characterization as first or second component goodwill.

In some situations, when the allocation of financial statement goodwill is made to the disposed business, a new temporary difference may arise in the retained reporting unit. We believe a change in the temporary difference due to the loss of tax basis in goodwill is akin to a change in the temporary difference arising from tax goodwill being reduced due to amortization. This would be true even if the operations that remain post-disposal were originally acquired in nontaxable transactions that generated only second component financial statement goodwill.

Similarly, if there was second component tax goodwill in the reporting unit pre-disposal, we believe first, and second component characterization determined in the acquisition accounting is still not subsequently reevaluated. However, entities have a policy choice between two acceptable methods for characterizing the reduction in tax goodwill.

- **Method A.** To the extent possible, allocate the impairment loss to any second component financial statement goodwill. Allocate any remaining impairment loss to first component goodwill.
- **Method B.** Allocate the impairment on a pro rata basis to the reporting unit's first component and second component financial statement goodwill.

These are the same policy elections available for allocating tax goodwill amortization to first and second component tax goodwill (see Question A.4.40). If an entity has already made a policy election for allocating tax goodwill amortization, we would generally expect it to apply that existing policy for allocating changes in tax goodwill resulting from disposals.



Example 5.4.60

Remaining tax effects of goodwill when a business is disposed of

On January 1, Year 1, ABC Corp. purchased the shares of DEF Corp. in a taxable business combination.

In the acquisition accounting, ABC recognized \$1,000 of financial statement goodwill and generated \$1,000 of tax goodwill (i.e. component one). ABC integrated DEF into an existing reporting unit with \$1,000 of nondeductible (second component financial statement) goodwill.

Reporting Unit's post-acquisition goodwill for financial statement and tax purposes is as follows.

	Financial statements	Tax basis
First component	\$1,000	\$1,000
Second component	1,000	—
Total goodwill	\$2,000	\$1,000

On December 31, Year 3, ABC disposes of its shares in DEF. The financial statement and tax goodwill amounts pre-disposal are as follows.

	Financial statements	Tax basis	Temp diffs	DTL
First component	\$1,000	\$800 ¹	\$200	\$42 ²
Second component	1,000	—		—
Total goodwill	\$2,000	\$800		\$42

Notes:

1. $\$1,000 - ((\$1,000 \div 15 \text{ years amortization period}) \times 3 \text{ years})$.
2. $(\$800 - \$1,000) \times 21\%$.

DEF's fair value represents 15% of Reporting Unit's fair value. As a result, ABC allocates to DEF \$300 ($\$2,000 \times 15\%$) of Reporting Unit's financial statement goodwill.

Because DEF’s financial statement goodwill was entirely first component at acquisition, the \$300 of goodwill allocated to it in the disposal is also entirely first component.

Reporting Unit’s financial statement and tax goodwill amounts post-disposal are as follows.

	Financial statements	Tax basis	Temp diffs
First component	\$ 700 ¹	–	\$700
Second component	1,000	–	
Remaining goodwill	\$1,700	\$0	

Note:
 1. \$1,000 (initial first component goodwill) - \$300 (portion allocated to DEF).

Before the disposal, Reporting Unit’s taxable temporary difference related to first component goodwill was \$200. After the disposal, it is \$700. The change in temporary difference is the net effect of:

- allocating \$300 first component financial statement goodwill to the disposal; and
- losing \$800 of first component tax goodwill.

ABC recognizes an incremental deferred tax liability for the \$500 (\$700 - \$200) increase in its first component taxable temporary difference.

6. Qualitative assessment

Detailed contents

6.1 How the standards work

6.2 Overview

Questions

- 6.2.10 What is the difference between the qualitative assessment and looking for impairment indicators between the annual tests?
- 6.2.20 If an entity elects to perform a qualitative assessment, must it apply that approach every period or for each reporting unit (or indefinite-lived intangible asset)?
- 6.2.30 Is a probability-weighted analysis required to evaluate the more-likely-than-not threshold?
- 6.2.40 How often is the qualitative assessment performed?

6.3 Performing the qualitative assessment

Questions

- 6.3.10 What approach could an entity follow for performing the qualitative assessment?
- 6.3.20 How can an entity develop a framework for determining when to perform a qualitative assessment?
- 6.3.30 If there was a cushion in the most recent fair value measurement, to what extent does that mitigate the need for quantitative testing?
- 6.3.40 How often should fair value measurements be updated to be used as a reference point in the qualitative assessment?
- 6.3.50 How does an entity determine the significant drivers of fair value?
- 6.3.60 How does an entity identify events and circumstances that may have affected the drivers of fair value?
- 6.3.70 How does an entity assess the drivers of fair value that are identified?
- 6.3.80 How does an entity identify events and circumstances that may have affected the carrying amount?
- 6.3.90 Once events, circumstances and factors have been identified, how does an entity complete its qualitative assessment?

Example

- 6.3.10 Performing the qualitative assessment

6.1 How the standards work

The following diagram is an adaptation of the impairment diagram in [chapter 1](#), showing the optional qualitative assessment as part of the impairment model for goodwill and indefinite-lived intangible assets.

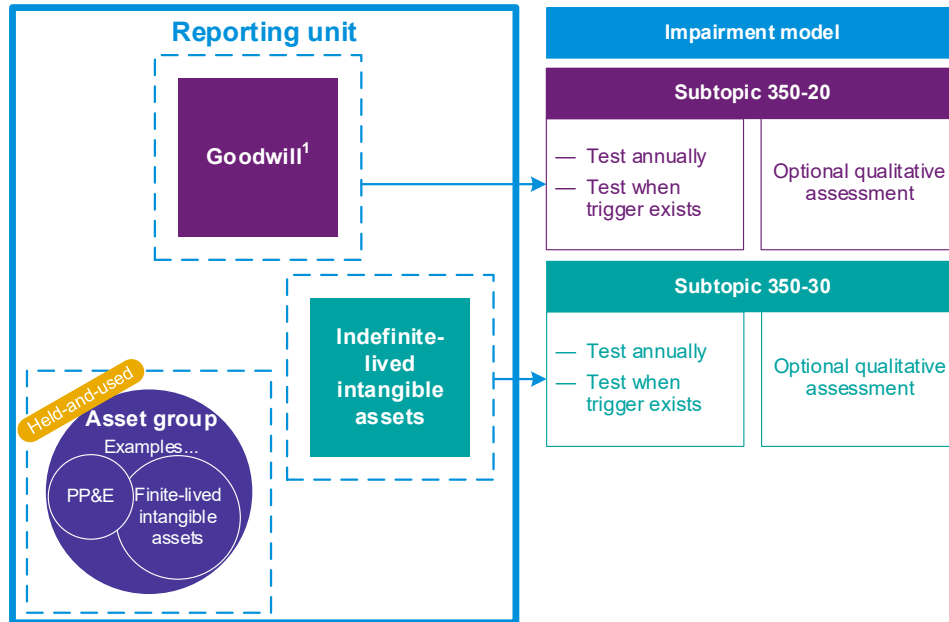

Note 1: Assumes (1) the entity has not elected the goodwill amortization accounting alternative (see chapter 11); and (2) ASU 2017-04 has been adopted (see Appendix A).

For each reporting unit (or indefinite-lived intangible asset), the qualitative assessment acts as a screen for determining if it is necessary to perform the quantitative test and requires a systematic approach in evaluating whether the annual quantitative test can be avoided.

This chapter refers to the following throughout:

- an indefinite-lived intangible asset, although the unit of account might be a grouping of such assets (see [section 3.2](#)); and
- an asset group, although the unit of account might be a single asset (see [section 3.3](#)).

6.2 Overview



Excerpt from ASC 350-20

> Overall Accounting for Goodwill

35-3 An entity may first assess qualitative factors, as described in paragraphs 350-20-35-3A through 35-3G, to determine whether it is necessary to perform the quantitative goodwill impairment test discussed in paragraphs 350-20-35-4 through 35-13. If determined to be necessary, the quantitative impairment test shall be used to identify goodwill impairment and measure the amount of a goodwill impairment loss to be recognized (if any).

> Recognition and Measurement of an Impairment Loss

• > Qualitative Assessment

35-3A An entity may assess qualitative factors to determine whether it is more likely than not (that is, a likelihood of more than 50 percent) that the fair value of a reporting unit is less than its carrying amount, including goodwill.

35-3B An entity has an unconditional option to bypass the qualitative assessment described in the preceding paragraph for any reporting unit in any period and proceed directly to performing the quantitative goodwill impairment test. An entity may resume performing the qualitative assessment in any subsequent period.

35-3C In evaluating whether it is more likely than not that the fair value of a reporting unit is less than its carrying amount, an entity shall assess relevant events and circumstances. Examples of such events and circumstances include the following:

- a. Macroeconomic conditions such as a deterioration in general economic conditions, limitations on accessing capital, fluctuations in foreign exchange rates, or other developments in equity and credit markets
- b. Industry and market considerations such as a deterioration in the environment in which an entity operates, an increased competitive environment, a decline in market-dependent multiples or metrics (consider in both absolute terms and relative to peers), a change in the market for an entity's products or services, or a regulatory or political development
- c. Cost factors such as increases in raw materials, labor, or other costs that have a negative effect on earnings and cash flows
- d. Overall financial performance such as negative or declining cash flows or a decline in actual or planned revenue or earnings compared with actual and projected results of relevant prior periods
- e. Other relevant entity-specific events such as changes in management, key personnel, strategy, or customers; contemplation of bankruptcy; or litigation
- f. Events affecting a reporting unit such as a change in the composition or carrying amount of its net assets, a more-likely-than-not expectation of selling or disposing of all, or a portion, of a reporting unit, the testing for recoverability of a significant asset group within a reporting unit, or

recognition of a goodwill impairment loss in the financial statements of a subsidiary that is a component of a reporting unit

g. If applicable, a sustained decrease in share price (consider in both absolute terms and relative to peers).

35-3D If, after assessing the totality of events or circumstances such as those described in the preceding paragraph, an entity determines that it is not more likely than not that the fair value of a reporting unit is less than its carrying amount, then the quantitative goodwill impairment test is unnecessary.

35-3E If, after assessing the totality of events or circumstances such as those described in paragraph 350-20-35-3C(a) through (g), an entity determines that it is more likely than not that the fair value of a reporting unit is less than its carrying amount, then the entity shall perform the quantitative goodwill impairment test.

35-3F The examples included in paragraph 350-20-35-3C(a) through (g) are not all-inclusive, and an entity shall consider other relevant events and circumstances that affect the fair value or carrying amount of a reporting unit in determining whether to perform the quantitative goodwill impairment test. An entity shall consider the extent to which each of the adverse events and circumstances identified could affect the comparison of a reporting unit's fair value with its carrying amount. An entity should place more weight on the events and circumstances that most affect a reporting unit's fair value or the carrying amount of its net assets. An entity also should consider positive and mitigating events and circumstances that may affect its determination of whether it is more likely than not that the fair value of a reporting unit is less than its carrying amount. If an entity has a recent fair value calculation for a reporting unit, it also should include as a factor in its consideration the difference between the fair value and the carrying amount in reaching its conclusion about whether to perform the quantitative goodwill impairment test.

35-3G An entity shall evaluate, on the basis of the weight of evidence, the significance of all identified events and circumstances in the context of determining whether it is more likely than not that the fair value of a reporting unit is less than its carrying amount. None of the individual examples of events and circumstances included in paragraph 350-20-35-3C(a) through (g) are intended to represent standalone events or circumstances that necessarily require an entity to perform the quantitative goodwill impairment test. Also, the existence of positive and mitigating events and circumstances is not intended to represent a rebuttable presumption that an entity should not perform the quantitative goodwill impairment test.



Excerpt from ASC 350-30

- > Intangible Assets Not Subject to Amortization

35-18A An entity may first perform a qualitative assessment, as described in this paragraph and paragraphs 350-30-35-18B through 35-18F, to determine whether it is necessary to perform the quantitative impairment test as

described in paragraph 350-30-35-19. An entity has an unconditional option to bypass the qualitative assessment for any indefinite-lived intangible asset in any period and proceed directly to performing the quantitative impairment test as described in paragraph 350-30-35-19. An entity may resume performing the qualitative assessment in any subsequent period. If an entity elects to perform a qualitative assessment, it first shall assess qualitative factors to determine whether it is more likely than not (that is, a likelihood of more than 50 percent) that an indefinite-lived intangible asset is impaired.

35-18B In assessing whether it is more likely than not that an indefinite-lived intangible asset is impaired, an entity shall assess all relevant events and circumstances that could affect the significant inputs used to determine the fair value of the indefinite-lived intangible asset. Examples of such events and circumstances include the following:

- a. Cost factors such as increases in raw materials, labor, or other costs that have a negative effect on future expected earnings and cash flows that could affect significant inputs used to determine the fair value of the indefinite-lived intangible asset
- b. Financial performance such as negative or declining cash flows or a decline in actual or planned revenue or earnings compared with actual and projected results of relevant prior periods that could affect significant inputs used to determine the fair value of the indefinite-lived intangible asset
- c. Legal, regulatory, contractual, political, business, or other factors, including asset-specific factors that could affect significant inputs used to determine the fair value of the indefinite-lived intangible asset
- d. Other relevant entity-specific events such as changes in management, key personnel, strategy, or customers; contemplation of bankruptcy; or litigation that could affect significant inputs used to determine the fair value of the indefinite-lived intangible asset
- e. Industry and market considerations such as a deterioration in the environment in which an entity operates, an increased competitive environment, a decline in market-dependent multiples or metrics (in both absolute terms and relative to peers), or a change in the market for an entity's products or services due to the effects of obsolescence, demand, competition, or other economic factors (such as the stability of the industry, known technological advances, legislative action that results in an uncertain or changing business environment, and expected changes in distribution channels) that could affect significant inputs used to determine the fair value of the indefinite-lived intangible asset
- f. Macroeconomic conditions such as deterioration in general economic conditions, limitations on accessing capital, fluctuations in foreign exchange rates, or other developments in equity and credit markets that could affect significant inputs used to determine the fair value of the indefinite-lived intangible asset.

35-18C The examples included in the preceding paragraph are not all-inclusive, and an entity shall consider other relevant events and circumstances that could affect the significant inputs used to determine the fair value of the indefinite-lived intangible asset. An entity shall consider the extent to which each of the adverse events and circumstances identified could affect the significant inputs used to determine the fair value of an indefinite-lived intangible asset. An entity

also shall consider the following to determine whether it is more likely than not that the indefinite-lived intangible asset is impaired:

- a. Positive and mitigating events and circumstances that could affect the significant inputs used to determine the fair value of the indefinite-lived intangible asset
- b. If an entity has made a recent fair value calculation for an indefinite-lived intangible asset, the difference between that fair value and the then carrying amount
- c. Whether there have been any changes to the carrying amount of the indefinite-lived intangible asset.

35-18D An entity shall evaluate, on the basis of the weight of the evidence, the significance of all identified events and circumstances that could affect the significant inputs used to determine the fair value of the indefinite-lived intangible asset for determining whether it is more likely than not that the indefinite-lived intangible asset is impaired. None of the individual examples of events and circumstances included in paragraph 350-30-35-18B(a) through (f) are intended to represent standalone events and circumstances that necessarily require an entity to calculate the fair value of an intangible asset. Also, the existence of positive and mitigating events and circumstances is not intended to represent a rebuttable presumption that an entity should not perform the quantitative impairment test as described in paragraph 350-30-35-19.

35-18E If after assessing the totality of events and circumstances and their potential effect on significant inputs to the fair value determination an entity determines that it is not more likely than not that the indefinite-lived intangible asset is impaired, then the entity need not calculate the fair value of the intangible asset and perform the quantitative impairment test in accordance with paragraph 350-30-35-19.

35-18F If after assessing the totality of events and circumstances and their potential effect on significant inputs to the fair value determination an entity determines that it is more likely than not that the indefinite-lived intangible asset is impaired, then the entity shall calculate the fair value of the intangible asset and perform the quantitative impairment test in accordance with the following paragraph.

If an entity concludes, based on a qualitative assessment, it is not more likely than not that a reporting unit (or indefinite-lived intangible asset) is impaired, the entity is not required to perform the quantitative test for that reporting unit (or indefinite-lived intangible asset). An entity has an unconditional option to bypass the qualitative assessment for a reporting unit (or indefinite-lived intangible asset) in any period and proceed directly to the quantitative impairment test. [\[350-20-35-30, 350-30-35-18A\]](#)



Question 6.2.10

What is the difference between the qualitative assessment and looking for impairment indicators between the annual tests?

Interpretive response: The factors considered in determining whether there is an indicator of impairment are the same as the factors considered in performing a qualitative assessment. Therefore, the guidance related to these factors in [section 4.3](#) applies and is not repeated in this chapter. And in both cases, the objective is determining whether it is more likely than not that the reporting unit (or indefinite-lived intangible asset) is impaired.

However, there is a different emphasis in the two sets of requirements that typically leads to a more formalized process in performing the qualitative assessment.

- In considering potential indicators of impairment, an entity is reviewing recent events and circumstances to assess whether there is evidence that changes its most recent conclusions. [[350-20-35-30](#), [350-30-35-18](#)]
- The qualitative assessment acts as a screen for determining if it is necessary to perform the quantitative test rather than a review of changes in events or circumstances. This requirement places a burden of proof on the entity that requires a more holistic approach. An entity considers the totality of the evidence when reaching its conclusion about the likelihood that the fair value of a reporting unit (or indefinite-lived intangible asset) is less than its carrying amount – considering negative evidence that may indicate the fair value of the reporting unit has declined as well as positive or mitigating evidence (see [section 6.3](#)).

For entities that do perform a qualitative assessment, the process followed is likely to provide a useful framework for considering potential indicators of impairment outside of the annual testing requirement (see [section 4.3](#)).



Question 6.2.20

If an entity elects to perform a qualitative assessment, must it apply that approach every period or for each reporting unit (or indefinite-lived intangible asset)?

Interpretive response: No. If an entity elects to perform a qualitative assessment, there is no requirement for the entity to perform it for every reporting unit (or for every indefinite-lived intangible asset). And there is no requirement for the qualitative assessment to be performed every period. [[350-20-35-3B](#), [350-30-35-18A](#)]

In each period and for each reporting unit (or indefinite-lived intangible asset), an entity decides whether it will reduce costs and complexity to perform the optional qualitative assessment (and risk failing) or to proceed directly to the quantitative test. For example, if in one period the entity decides not to perform

a qualitative assessment for a certain reporting unit, it may perform it in the next period.



Question 6.2.30

Is a probability-weighted analysis required to evaluate the more-likely-than-not threshold?

Interpretive response: No. Subtopics 350-20 and 350-30 specify the threshold of whether it is more than 50% likely that the fair value of a reporting unit (or indefinite-lived intangible asset) is less than its carrying amount. However, we do not believe that threshold is intended to require a probability-weighted analysis of potential outcomes to support the conclusion reached in the qualitative assessment. [350-20-35-3A, 350-30-35-18A]

Nonetheless, a process is needed (see [Question 6.3.10](#)) to:

- identify qualitative factors that could significantly affect the fair value of a reporting unit (or indefinite-lived intangible asset); and
 - evaluate the potential effect of changes in those factors on the fair value to support a conclusion that the quantitative impairment test is unnecessary.
-



Question 6.2.40

How often is the qualitative assessment performed?

Interpretive response: Annually, if the entity elects to perform a qualitative assessment. Because the optional qualitative assessment is intended to determine if the annual quantitative testing is required, it follows that the qualitative assessment should be carried out annually. However, the assessment should be timed such that if quantitative testing is required, it can be completed within the timeframe required for annual tests (see [section 4.2](#)).

Note: The factors to consider when evaluating whether there is a triggering event (see [section 4.3](#)) are the same as the factors to consider in the qualitative assessment although the latter is typically a more formal process (see [Question 6.2.10](#)). After a triggering event, a qualitative analysis would likely indicate the entity should move to the quantitative impairment test. [350-20-35-3C, 35-66]

6.3 Performing the qualitative assessment



Question 6.3.10

What approach could an entity follow for performing the qualitative assessment?

Interpretive response: An entity should consider the totality of evidence in reaching its conclusion about the likelihood that the fair value of a reporting unit (or indefinite-lived intangible asset) is less than its carrying amount. This assessment includes negative evidence that may indicate that the fair value of the reporting unit (or indefinite-lived intangible asset) has declined, as well as positive or mitigating evidence.

Specifically, for each unit of account an entity should:

- identify the most significant factors that could affect its fair value;
- identify relevant recent events and circumstances that could affect those factors; and
- evaluate how those events and circumstances may have affected the fair value.

We recommend the following steps to ensure a systematic approach in evaluating whether the annual quantitative test can be avoided.

See Q&A

Step 1	Develop a framework to determine when the entity will perform a qualitative assessment and when it will proceed directly to the quantitative test.	6.3.20
Step 2	If a qualitative assessment will be performed, consider the most recent fair value measurement and when that measurement was determined.	6.3.30 6.3.40
Step 3	Identify the significant drivers of fair value .	6.3.50
Step 4	Determine what events and circumstances have occurred that may have affected those drivers of fair value, including positive and mitigating events and circumstances.	6.3.60
Step 5	Assess the likely impact of the factors identified in the previous steps on the fair value.	6.3.70
Step 6	Consider any transactions or events that significantly affected the carrying amount.	6.3.80
Step 7	Prepare an analysis based on the events, circumstances and factors identified and document the assessment of whether it is more likely than not that fair value is less than the carrying amount.	6.3.90

The indicators in the qualitative test do not need be definitive that an asset is impaired before proceeding to the quantitative test. If an entity concludes that it is more likely than not that the asset is impaired, the quantitative test (see [chapter 8](#)) may still conclude that there is no impairment.



Question 6.3.20

How can an entity develop a framework for determining when to perform a qualitative assessment?

Step 1: Develop a framework to determine when the entity will perform a qualitative assessment and when it will proceed directly to the quantitative test.

Interpretive response: Because the qualitative assessment is optional, an entity should consider establishing a framework for determining when it will perform a qualitative assessment and when it will proceed directly to the quantitative test. An entity could establish criteria that, if met, would result in bypassing the qualitative assessment and proceeding directly to the quantitative test. The objective of these criteria should be to determine when it would be cost effective to perform a qualitative assessment versus when it would be more cost effective to proceed directly to the quantitative test.

An entity might go directly to the quantitative test when, for example:

- there was only a small cushion in the last fair value measurement (see [Question 6.3.30](#));
- there has been a significant decline in the underlying sales or in the macro-economic prospects of the country or region in which the reporting unit (or indefinite-lived intangible asset) operates; or
- the unit of account is an IPR&D asset – because of the inherent uncertain nature and the challenges involved in valuing such assets with many unknown factors (see [section 8.5](#)).

A combination of these factors might influence the entity more strongly to go directly to the quantitative test.



Question 6.3.30

If there was a cushion in the most recent fair value measurement, to what extent does that mitigate the need for quantitative testing?

Step 2: If a qualitative assessment will be performed, consider the most recent fair value measurement and when that measurement was determined.

Interpretive response: If an entity decides in Step 1 to perform a qualitative assessment, it should begin by considering the significance of any cushion in the most recent fair value measurement – i.e. the excess of the fair value

measurement over the carrying amount of the reporting unit (or indefinite-lived intangible asset).

In general, a significant cushion is more likely to lead to the entity concluding that a quantitative assessment is unnecessary. However, this conclusion is not automatic. The significance of the *cushion* is just one of the factors to consider in the qualitative assessment. The entity also needs to consider the following (not exhaustive).

- The relevance and reliability of the most recent fair value measurement (see [Question 6.3.40](#)). As more time passes, the previous measurement becomes less relevant.
- The nature and significance of any events or circumstances that may indicate the reporting unit (or indefinite-lived intangible asset) is more likely than not impaired. Changes in the operations or the economic environment could indicate it is more likely than not that the fair value is less than the carrying amount of the reporting unit (or indefinite-lived intangible asset). See [Question 6.3.60](#).
- The nature and significance of any positive and mitigating events or circumstances. The absence of significant positive or mitigating events or circumstances may indicate more cushion is needed.

The SEC staff has indicated that a reporting unit may be at risk of failing the quantitative test for goodwill impairment if it had a fair value that was not substantially in excess of the carrying amount of the reporting unit as of the date of the last quantitative impairment test. [\[2009 AICPA Conf\]](#)

In these situations, it may be more cost effective to proceed directly to the quantitative test; this avoids the increased burden of proof in asserting it is more likely than not that the fair value of the reporting unit equals or exceeds its carrying amount.



Question 6.3.40

How often should fair value measurements be updated to be used as a reference point in the qualitative assessment?

Step 2: If a qualitative assessment will be performed, consider the most recent fair value measurement and when that measurement was determined.

Interpretive response: As noted in [Question 6.3.30](#), in performing the qualitative assessment a fair value measurement becomes less relevant as more time passes. While an entity is not required to measure fair value at regular intervals, it may be appropriate or cost effective to periodically quantitatively determine the fair value of a reporting unit (or indefinite-lived intangible asset).

If an entity does periodically refresh its most recent fair value measurement, the frequency required will depend on many factors, including the amount of cushion in the most recent assessment and the inherent volatility in the underlying cash flows.

For a reporting unit, factors to consider in determining whether more frequent quantitative measurements may be appropriate include:

- changes in the composition of the reporting unit due to partial dispositions, acquisitions or reorganizations;
- the maturity of the goods or services provided by the reporting unit;
- barriers to entry for competitors; and
- susceptibility of the fair value to foreign currency exchange rates, interest rates, commodity prices or other macro-economic factors.

For example, less frequent quantitative measurements may be more appropriate for a reporting unit that has a well-established market share in a mature industry than for a reporting unit in an industry that experiences shorter product lifecycles, is subject to rapid technological changes, and/or has low barriers to entry.



Question 6.3.50

How does an entity determine the significant drivers of fair value?

Step 3: Identify the significant drivers of fair value.

Interpretive response: The significant drivers of fair value are developed from the entity's understanding of the business and the underlying assets, as well as the key estimates and assumptions used in previous fair value measurements. Subtopic 350-30 specifically references the significant inputs (drivers) used to determine the fair value of indefinite-lived intangible assets; these inputs are also relevant for reporting units. For a discussion of fair value, including the inputs and therefore common drivers of value, see [chapter 8](#). [350-30-35-18C]

An entity should also consider results from projections and analyses it prepared when it acquired target(s) whose goodwill is included in the reporting unit and/or when it acquired target(s) with indefinite-lived intangible assets. [350-20-35-3C, 350-30-35-18B]



Question 6.3.60

How does an entity identify events and circumstances that may have affected the drivers of fair value?

Step 4: Determine what events and circumstances have occurred that may have affected those drivers of fair value, including positive and mitigating events and circumstances.

Interpretive response: Once the key assumptions and drivers of fair value have been identified, the entity should comprehensively consider all facts and circumstances relevant to the underlying business of the reporting unit (or

activities relevant to the indefinite-lived intangible asset) and whether there have been significant changes in:

- the business model, strategy or operations; or
- the economic environment in which the reporting unit (or asset) operates.

This analysis should emphasize consideration of the key drivers or factors identified in Step 3 and other relevant factors identified by the entity.

Although Subtopics 350-20 and 350-30 do not provide examples, they do state that the entity should consider positive and mitigating events and circumstances in making its qualitative assessment. It is the totality of all of the factors, both positive and negative, that an entity evaluates in its more-likely-than-not assessment. In that regard, it is important to not solely focus on events and circumstances that support a positive outcome, but to identify all available information that is both positive and negative. [350-20-35-3G, 350-30-35-18D]

The following are examples.

- A healthy current-year increase in revenue and operating profit, together with similar growth projected for the next five years, may appear to indicate a healthy business; however, this could be either a positive or a negative factor with respect to fair value measurement. If these metrics represent a decline from what was previously projected, then they are a negative factor.
- A new workforce contract should be considered against previous projections of labor costs to determine whether it is a positive or negative factor in measuring fair value.
- A specialist firm that loses key personnel may be at risk of losing recurring customer contracts, technical qualifications and/or market connections. These potential consequential events should be considered in evaluating the effect on fair value.
- An entity that loses a large customer should be careful not to simply assume that the redeployed sales force will replace the future lost revenues. The entity should consider specific strategies, facts or circumstances that would overcome the lost revenue.

These factors should be reviewed at regular intervals to identify new factors that could affect fair value and to ensure that the previously identified factors continue to be significant drivers of fair value.



Question 6.3.70

How does an entity assess the drivers of fair value that are identified?

Step 5: Assess the likely impact of the factors identified in the previous steps on the fair value.

Interpretive response: Once an entity has identified the key drivers of fair value in [Question 6.3.50](#), it assesses the potential effect of each of those

drivers on the fair value – considering relevant positive and mitigating events and circumstances.

This assessment includes considering consistency with other information such as the entity’s operating budgets, forecasts and strategic plans. It is important to not focus solely on events and circumstances that support a certain outcome, but to identify all relevant available information, whether positive or negative.

Similar to other estimates and more-likely-than-not assessments that an entity makes, it is important to develop a process for gathering the internal and external data to support the conclusions of the qualitative assessment.



Question 6.3.80

How does an entity identify events and circumstances that may have affected the carrying amount?

Step 6: Consider any transactions or events that significantly affected the carrying amount.

Interpretive response: An entity will need to consider any changes in the business (or activities) that occurred during the reporting period that could affect the carrying amount of the reporting unit (or indefinite-lived intangible asset). This includes changes in the composition of the unit of account (see [chapter 3](#)) and/or its carrying amount (see [chapter 5](#)). Significant changes could result in it being more cost effective to proceed directly to the quantitative test instead of performing a qualitative assessment.

Examples of transactions and events that could significantly affect the carrying amount include: [\[350-20-35-3C\(f\), 350-30-35-18C\(c\), 35-27\]](#)

- the disposal of a portion of a reporting unit;
- a business combination during the period;
- significant changes in the underlying functional currency;
- a reorganization of the entity’s operating segments, reporting units or assets; or
- changes in the use of intangible assets, resulting in indefinite-lived intangible assets that were previously tested separately being combined as a single unit of account.



Question 6.3.90

Once events, circumstances and factors have been identified, how does an entity complete its qualitative assessment?

Step 7: Prepare an analysis based on the events, circumstances and factors identified and document the assessment of whether it is not more likely than not that fair value is less than the carrying amount.

Interpretive response: Once the entity has completed Steps 1 - 6, it needs to consider the totality of the evidence gathered to reach its conclusion.

Because the qualitative assessment acts as a screen for determining if it is necessary to perform the quantitative impairment test, the entity needs to obtain sufficient evidence to support a conclusion that it is more likely than not that the fair value of the reporting unit (or indefinite-lived intangible asset) equals or exceeds its carrying amount. The level of detail needed in the analysis will vary based on the specific facts and circumstances.

Because of the complexities of the offsetting effects of the various events and circumstances identified, and the overall effect on the more-likely-than-not assessment, the entity may need to involve its valuation professional to assist in the assessment and/or reviewing the conclusion.

We expect the entity's considerations to be documented, including how the entity weighted the evidence gathered, the estimated effect of the information on the fair value as part of its qualitative assessment, and how the entity determined it is not more likely than not that the fair value is less than its carrying amount. As part of the analysis, we expect the documentation to conclude whether each of the events or circumstances identified for each key driver are positive, neutral or negative evidence. The extent of the evidence needed to support that conclusion would generally increase as the likelihood that the fair value is less than the carrying amount increases.



Example 6.3.10

Performing the qualitative assessment

Manufacturer has three reporting units: RU-A, RU-B and RU-C. Manufacturer performed quantitative testing in Year 1 that indicated the following excess of fair value over the carrying amount for each reporting unit.

	Fair value	Carrying amount	% excess
RU-A	\$195	\$180	8%
RU-B	400	230	74%
RU-C	360	150	140%

Assessment of RU-A

RU-A's Year 2 revenues are in line with its forecast, but profitability is falling short of budget because of a labor dispute at its primary manufacturing location;

the resolution of the dispute has resulted in higher than expected labor costs in Year 2. It is uncertain whether the higher costs will be recovered through future price increases and currently there are no formal plans to implement cost saving initiatives to increase future profitability.

Manufacturer follows the framework to determine whether it should perform a quantitative test for RU-A.

- **Step 1:** Manufacturer carries out a qualitative assessment for all reporting units for which there is a fair value measurement not more than two years old (in accordance with its policy).
- **Step 2:** There is only a small cushion (8%) from the previous year's fair value measurement.
- **Step 3:** Both revenues and operating costs are significant drivers of fair value, as is the stability of Manufacturer's relationship with its workforce. *Note:* The analysis of the drivers of fair value will typically be more detailed than presented here (see [Question 6.3.50](#)).
- **Step 4:** Although revenues are higher, this level of growth was expected by analysts; labor costs are higher and there are no mitigation plans; Manufacturer's relationship with its workforce is less stable because of the current labor dispute.
- **Step 5:** The higher revenues have no effect on the assessment because that level of growth was expected by analysts (and was therefore factored into the latest fair value measurement); higher than expected labor costs are a negative factor because the dispute was not anticipated; the dispute with the workforce is a negative factor because it was unexpected and results in a less stable labor relationship.
- **Step 6:** No transactions or events significantly affected the carrying amount of RU-A.
- **Step 7:** Based on the evidence gathered in Steps 2 to 5, Manufacturer concludes that it needs to carry out a quantitative test for RU-A – i.e. it is more likely than not that RU-A's fair value is less than its carrying amount. Manufacturer proceeds with a quantitative test for RU-A.

Assessment of RU-B and RU-C

RU-B's and RU-C's Year 2 operating results have exceeded prior-year projections and continued growth is expected for the foreseeable future; this is because of favorable macroeconomic conditions and strong product demand.

Manufacturer follows the framework to determine whether it should perform a quantitative test for each of RU-B and RU-C.

- **Step 1:** Manufacturer carries out a qualitative assessment for all reporting units for which there is a fair value measurement not more than two years old (in accordance with its policy).
- **Step 2:** There were significant cushions from the previous year's fair value measurements: 74% for RU-B and 140% for RU-C.
- **Step 3:** Both revenues and operating costs are significant drivers of fair value, as is the stability of Manufacturer's relationship with its workforce.

Note: The analysis of the drivers of fair value will typically be more detailed than presented here (see [Question 6.3.50](#)).

- **Step 4:** Operating results have exceeded prior-year projections, together with favorable macroeconomic conditions and strong product demand; although there is no labor dispute currently affecting either RU-B or RU-C, management is monitoring whether the issue might spread from RU-A.
 - **Step 5:** The better than expected operating results have a positive effect on the assessment because they exceed analyst expectations, and trading conditions remain strong; RU-A's dispute with the workforce is a negative factor because of the possibility that it spreads, but management has taken steps to resolve the dispute and the risk is assessed as low.
 - **Step 6:** No transactions or events significantly affected the carrying amount of RU-A.
 - **Step 7:** Based on the evidence gathered in Steps 2 to 5, Manufacturer concludes that it does not need to carry out a quantitative test for either RU-B or RU-C – i.e. it is able to conclude it is not more likely than not that RU-B's and RU-C's fair values are less than their respective carrying amounts. Manufacturer documents its assessment for RU-B and RU-C.
-

7. Recoverability test: Long-lived assets

Detailed contents

7.1 How the standards work

7.2 General principles

Questions

- 7.2.10 What are the general principles for estimating future cash flows for the recoverability test?
- 7.2.20 Are detailed estimates of future cash flows always required?
- 7.2.30 Are cash flows based on a single best estimate or probability-weighted?
- 7.2.40 Is the same approach to estimating future cash flows required for all asset groups?
- 7.2.50 Must the assumptions used in estimating future cash flows be consistent with other assumptions made by the entity?
- 7.2.60 How is the recoverability test performed for a foreign entity whose local currency is not the reporting entity's functional currency?
- 7.2.70 How are future cash flows estimated if substantial doubt is raised about the entity's ability to continue as a going concern?
- 7.2.80 How are future cash flows estimated if the entity is contemplating a bankruptcy filing?
- 7.2.90 How do new conditions arising after the reporting date affect the recoverability test?

Examples

- 7.2.10 Asset group is part of a foreign entity
- 7.2.20 Decision to dispose of asset group after year-end

7.3 The primary asset

Questions

- 7.3.10 What is the significance of the primary asset?
- 7.3.20 How does an entity identify the primary asset?
- 7.3.30 How are future cash flows determined if the primary asset is nearing the end of its useful life?
- 7.3.40 How are future cash flows determined if the entity intends to abandon the primary asset?

- 7.3.50 Are future cash flows adjusted to reflect revisions to the primary asset's remaining useful life or salvage value?
- 7.3.60 If an entity expects to settle a liability with the primary asset, what is the asset's remaining useful life?
- 7.3.70 Can the primary asset be a single customer relationship intangible asset?

Examples

- 7.3.10 Primary asset in an asset group
- 7.3.20 Useful life is less than economic life

7.4 Cash flows from operation

Questions

- 7.4.10 Do estimated future cash flows include income taxes?
- 7.4.20 Do estimated future cash flows include principal repayments of debt?
- 7.4.30 Do estimated future cash flows include lease payments?
- 7.4.35 Do estimated future cash flows include sublease rental income?
- 7.4.40 Do estimated future cash flows include payments related to capitalized asset retirement costs?
- 7.4.50 Do estimated future cash flows include the cost of maintaining and replacing assets?
- 7.4.60 Do estimated future cash flows include the cost of completing assets under development?
- 7.4.70 Do estimated future cash flows consider the utilization of current excess capacity?
- 7.4.80 To what extent do estimated future cash flows include cash inflows from new customers?
- 7.4.90 Do estimated future cash flows include the benefit of unrecognized intangible assets?
- 7.4.100 Do estimated future cash flows include the benefit of goodwill related to the reporting unit in which the asset group resides?
- 7.4.110 How are shared costs incorporated into estimated future cash flows?
- 7.4.120 Are estimated future cash flows used in the recoverability test adjusted for the benefit of trade names and IP that reside outside the asset group?
- 7.4.130 Do estimated future cash flows take into account hedging instruments related to long-lived assets?

- 7.4.140 How are future cash flows estimated when government credits classified as inventory are distributed to owners instead of being sold?
- 7.4.150 Does the general partner include limited partners' preferred return as a cash outflow when it consolidates the partnership?
- 7.4.160 Do estimated future cash flows of a mono-line insurance entity include investment cash flows if the asset group is the entire entity?
- 7.4.170 Do estimated future cash flows include insurance recoveries for property damage?
- 7.4.180 Do estimated future cash flows include business interruption insurance recoveries?

7.5 Cash flows from disposition

Questions

- 7.5.10 Is it always necessary to estimate future cash flows from disposition?
- 7.5.20 How are future cash flows from disposition estimated?
- 7.5.30 Do estimated future cash flows from disposition include income taxes?
- 7.5.40 How are future cash flows from disposition estimated when the asset group is a business?
- 7.5.50 If an asset group includes all of the entity's long-lived assets, do estimated future cash flows from disposition assume disposal of the entire business?
- 7.5.60 If an entity expects to settle a liability with the primary asset, what is the asset's disposition value?

7.6 Site restoration and environmental exit costs

Question

- 7.6.10 Do estimated future cash flows include exit costs to remediate environmental contamination?

7.7 Enterprise assets

Question

- 7.7.10 How is the recoverability test performed for an asset group that includes an enterprise asset?

Example

- 7.7.10 Recoverability test for an enterprise asset

7.1 How the standards work

A quantitative test for long-lived assets is required when the entity concludes that there has been an event or change in circumstances that indicates that the carrying amount of an asset may not be recoverable.

The following diagram highlights the process to evaluate whether a long-lived asset impairment exists (Step 1); and if so, the measurement, recognition and allocation principles. This chapter is focused on Step 1 of the impairment test, the undiscounted cash flow analysis.

Topic 360	Evaluation and measurement	Recognition	Allocation
Held-and-used Long-lived assets	Step 1: Undiscounted cash flows Step 2: Fair value	Excess of carrying amount over fair value	Reduce carrying amount of assets in scope on pro rata basis (subject to fair value limitation)

Step 1 in the evaluation and measurement process is the recoverability test, in which the estimated, undiscounted future cash flows expected to result from the use and eventual disposition of the asset (asset group) are compared to the carrying amount of the asset (asset group).

As shown in the following diagram, if there is a surplus (i.e. the undiscounted future cash flows exceed the carrying amount), no impairment exists and therefore no further work is required. However, an entity moves to Step 2 and fair value measurement if the undiscounted cash flows are less than the carrying amount of the asset group.

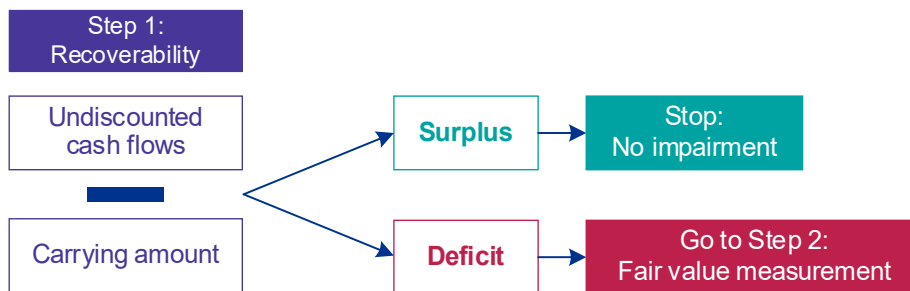

This chapter refers to the following throughout:

- an indefinite-lived intangible asset, although the unit of account might be a grouping of such assets (see [section 3.2](#)); and
- an asset group, although the unit of account might be a single asset (see [section 3.3](#)).

7.2 General principles



Excerpt from ASC 360-10

- > Long-Lived Assets Classified as Held and Used

35-16 This guidance addresses how long-lived assets or asset groups that are intended to be held and used in an entity's business shall be reviewed for impairment.

- > Measurement of Impairment Loss

35-17 An impairment loss shall be recognized only if the carrying amount of a long-lived asset (asset group) is not recoverable if it exceeds the sum of the undiscounted cash flows expected to result from the use and eventual disposition of the asset (asset group). That assessment shall be based on the carrying amount of the asset (asset group) at the date it is tested for recoverability, whether in use (see paragraph 360-10-35-33) or under development (see paragraph 360-10-35-34). An impairment loss shall be measured as the amount by which the carrying amount of a long-lived asset (asset group) exceeds its fair value.

- > Estimates of Future Cash Flows Used to Test a Long-Lived Asset for Recoverability

35-29 Estimates of future cash flows used to test the recoverability of a long-lived asset (asset group) shall include only the future cash flows (cash inflows less associated cash outflows) that are directly associated with and that are expected to arise as a direct result of the use and eventual disposition of the asset (asset group). Those estimates shall exclude interest charges that will be recognized as an expense when incurred.

Under Step 1 (recoverability test), the undiscounted expected future cash flows from an asset group are compared to the asset group's carrying amount. If the carrying amount (see [section 5.3](#)) exceeds the undiscounted estimated future cash flows, the entity is required to perform Step 2 (fair value test – see [chapter 8](#)).



Question 7.2.10

What are the general principles for estimating future cash flows for the recoverability test?

Interpretive response: The following general principles, which are discussed throughout this chapter, apply in estimating future cash flows for purposes of the recoverability test.

Entity perspective	The cash flows are based on the entity's own assumptions about its use of the asset group. [360-10-35-30]
Current level of service capacity	The cash flows are based on the asset group's current physical output and cash flow generation capacity. [360-10-35-33]
From use and disposition	The cash flows are based on the operation and ultimate disposal of the asset group. The period of operation is based on the useful life of the 'primary' asset. [360-10-35-31]
Excludes financing	The cash flows exclude interest charges that will be recognized as an expense when incurred. [360-10-35-29]
Undiscounted	The cash flows are not discounted to a present value.

In addition to the above general principles, there is a specific requirement that the cash outflows related to a recognized ARO be excluded from the recoverability test. [360-10-35-18(a)]

Question 7.2.20

Are detailed estimates of future cash flows always required?

Interpretive response: No. An entity may have an indicator of impairment but be able to satisfy itself that there is no impairment loss by doing some analysis without the need for detailed projections. Management would need to document its assessment very carefully to support its conclusion that the recoverability test is passed notwithstanding the absence of detailed estimates of future cash flows.

For example, the entity may be able to demonstrate that the fair value of an asset group exceeds its carrying amount such that no impairment loss would be necessary if the Step 2 fair value test was performed. In that case, performing the Step 1 recoverability test would not be meaningful.

It may also be possible for an entity to demonstrate easily that the estimated future cash flows would far exceed the carrying amount of an asset group. For example, if the asset group has been profitable historically and the entity does not expect a decrease in profitability in future periods, the entity might be able to apply a sensitivity analysis to previous historical results showing that the recoverability test would pass with a wide margin.

However, in an unstable economic environment and a wide range of possible future cash flows, entities may be unable to conclude that detailed estimates of future cash flows are not needed.

See related [Question 7.5.10](#) on whether an entity is always required to estimate future cash flows from disposition of the asset group.



Question 7.2.30

Are cash flows based on a single best estimate or probability-weighted?

Interpretive response: It depends. The general requirement in Topic 360 is for the entity to consider all available evidence, and for the underlying assumptions to be consistent with those used for other estimates (see [Question 7.2.50](#)). Further, the likelihood of the different outcomes needs to be considered if: [360-10-35-30]

- the entity is considering alternative courses of action for the operation or disposition of the asset group; and/or
- there is a range of possible future cash flows.

In our experience, in a stable economic environment, estimated future cash flows are typically based on the entity's best estimate unless it is considering alternative courses of action for an asset group, in which case a probability-weighted approach is used. [Example 2 \(Case A\)](#) in Topic 360 illustrates using probability-weighted cash flows to consider whether the carrying amount of an asset group is recoverable.

However, as the economic environment becomes less stable and the range of possible future cash flows widens, entities are more likely to base their recoverability test on probability-weighted cash flows.



Excerpt from ASC 360-10

- > Example 2: Probability-Weighted Cash Flows

55-23 This Example illustrates the use of a probability-weighted approach for developing estimates of future cash flows used to test a long-lived asset for recoverability when alternative courses of action are under consideration (see paragraph 360-10-35-30). This Example has the following Cases:

- a. Probability-weighted cash flows (Case A)
- b. Expected cash flows technique (Case B).

55-24 Cases A and B share all of the following assumptions.

55-25 As of December 31, 20X2, a manufacturing facility with a carrying amount of \$48 million is tested for recoverability. At that date, 2 courses of action to recover the carrying amount of the facility are under consideration—sell in 2 years or sell in 10 years (at the end of its remaining useful life).

55-26 The possible cash flows associated with each of those courses of action are \$41 million and \$48.7 million, respectively. They are developed based on entity-specific assumptions about future sales (volume and price) and costs in varying scenarios that consider the likelihood that existing customer relationships will continue, changes in economic (market) conditions, and other relevant factors.

• • > Case A: Probability-Weighted Cash Flows

55-27 The following table shows the possible cash flows associated with each of the courses of action—sell in 2 years or sell in 10 years.

Course of Action	Cash Flows (Use) (in \$ millions)	Cash Flows (Disposition) (in \$ millions)	Cash Flows (Total) (in \$ millions)	Probability Assessment	Possible Cash Flows (Probability-Weighted) (in \$ millions)
Sell in 2 years	\$ 8	\$ 30	\$ 38	20%	\$ 7.6
	11	30	41	50	20.5
	13	30	43	30	12.9
					<u>\$ 41.0</u>
Sell in 10 years	\$ 36	\$ 1	\$ 37	20%	\$ 7.4
	48	1	49	50	24.5
	55	1	56	30	16.8
					<u>\$ 48.7</u>

55-28 As further indicated in the following table, there is a 60 percent probability that the facility will be sold in 2 years and a 40 percent probability that the facility will be sold in 10 years.

55-29 The alternatives of whether to sell or use an asset are not necessarily independent of each other. In many situations, after estimating the possible future cash flows relating to those potential courses of action, an entity might select the course of action that results in a significantly higher estimate of possible future cash flows. In that situation, the entity generally would use the estimates of possible future cash flows relating only to that course of action in computing future cash flows. As shown, the expected cash flows are \$44.1 million (undiscounted). Therefore, the carrying amount of the facility of \$48 million would not be recoverable.

Course of Action	Possible Cash Flows (Probability-Weighted) (in \$ millions)	Probability Assessment (Course of Action)	Expected Cash Flows (Undiscounted) (in \$ millions)
Sell in 2 years	\$ 41.0	60%	\$ 24.6
Sell in 10 years	48.7	40	19.5
			<u>\$ 44.1</u>



Question 7.2.40

Is the same approach to estimating future cash flows required for all asset groups?

Interpretive response: No. Topic 360 does not require an entity to apply a single approach to testing all asset groups for recoverability. An entity should apply the approach (single best estimate or probability-weighted) that is most suitable to the facts and circumstances.

However, in general, we believe that for asset groups with similar facts and circumstances – e.g. similar cash flow streams and/or uncertainties associated

with the cash flows – the entity should use similar approaches to estimate the future cash flows.



Question 7.2.50

Must the assumptions used in estimating future cash flows be consistent with other assumptions made by the entity?

Interpretive response: Yes. The assumptions underlying the estimates of future cash flows must be consistent with the assumptions underpinning other information prepared by the entity, regardless of whether that information has been communicated publicly. Examples include internal budgets and projections, accruals related to incentive compensation plans and MD&A. [360-10-35-30]

The SEC staff has reinforced that the assumptions used to develop cash flows for purposes of applying Topic 360 must be consistent with other financial statement calculations and disclosures, including disclosures in MD&A and other public communications. See also [section 10.3](#), which discusses the disclosure expectations of registrants. [360-10-S99-2]

We do not believe that the Topic 360 or SEC staff guidance literally requires an entity to use the same amounts of cash flows from one estimate to another. However, cash flows used in the recoverability test should be reconcilable to internal forecasts and budgets and the cash flows used in other financial statement measurements.



Question 7.2.60

How is the recoverability test performed for a foreign entity whose local currency is not the reporting entity's functional currency?

Interpretive response: The recoverability test is performed in an entity's functional currency. This applies even if the entity's books of record are not maintained in the functional currency – e.g. a foreign subsidiary where the local currency is not the entity's functional currency. This could result in a functional currency impairment or the reversal of a local currency impairment. [830-10-45-17 – 45-18]



Example 7.2.10

Asset group is part of a foreign entity

Parent has a foreign subsidiary (Foreign Sub) whose functional currency is the US dollar. Foreign Sub acquires a building to be held and used in the local currency, which is a separate asset group. As a result of significant operating

losses in the current year, Foreign Sub concludes that the building should be tested for impairment.

Foreign Sub prepares an analysis of the estimated future cash flows in local currency, which indicates that the carrying amount in local currency is recoverable. However, as a result of the devaluation of the local currency, the US dollar value equivalent of the undiscounted cash flows indicates that the carrying amount of the building in US dollars (functional currency) is not recoverable. As a result, the asset group fails the recoverability test.



Question 7.2.70

How are future cash flows estimated if substantial doubt is raised about the entity's ability to continue as a going concern?

Interpretive response: Certain disclosure requirements are triggered under Subtopic 205-40 when an entity's management concludes it is probable that the entity will not be able to meet its obligations falling due within one year of the date its financial statements are issued (or available to be issued) – i.e. substantial doubt is raised.

Even though the disclosures may mean management has substantial doubt about the entity's ability to continue as a going concern, the financial statements continue to be presented on a going concern basis – unless management concludes that a different basis is appropriate – e.g. liquidation basis of accounting. [\[205-30-25-1\]](#)

Therefore, although the estimated future cash flows should contemplate the factors that gave rise to the substantial doubt, the forecast period should reflect the primary asset's remaining useful life in the usual way (see [section 7.3](#)) provided the entity expects to operate the asset group through that date. The forecast period is not limited to one year from the date the financial statements will be issued (will be available to be issued). However, in this situation often the entity is considering alternative courses of action (such as plans to alleviate substantial doubt) and/or the range of possible future cash flows has widened; therefore, the use of probability-weighted cash flows is more likely ([Question 7.2.40](#)).

For in-depth discussion of how management performs its going concern assessment and making appropriate disclosures, see KPMG Handbook, [Going concern](#).



Question 7.2.80

How are future cash flows estimated if the entity is contemplating a bankruptcy filing?

Interpretive response: In the period preceding bankruptcy, an entity continues to follow applicable US GAAP when preparing its financial statements.

Therefore, Topic 360 is applied in the usual way and the forecast period is not limited to the potential timing of a bankruptcy filing.

The estimated future cash flows should take into account the factors that have led to the potential bankruptcy filing, including the possible scenarios that might arise following the filing. The relevance of using probability-weighted cash flows will be heightened in this case (see [Question 7.2.30](#)).

For in-depth discussion of the relevant accounting issues before, during and after emerging from bankruptcy, see KPMG Handbook, [Accounting for bankruptcies](#).



Question 7.2.90

How do new conditions arising after the reporting date affect the recoverability test?

Interpretive response: Estimates of cash flows and asset values for purposes of testing long-lived assets for recoverability should be based on conditions that exist at the reporting date and hindsight should not be considered. [360-10-35-17]

However, the likelihood of alternative courses of action to recover the carrying amount of an asset group is considered. For example, the possibility of selling an asset group might be a consideration in estimating future cash flows even though the criteria for held-for-sale classification might not be met at the reporting date. [360-10-35-30]

Because it is difficult to separate the benefit of hindsight when assessing conditions existing at an earlier date, it is important that judgments about those conditions, the need to test an asset for recoverability, and the application of a recoverability test be made and documented together with supporting evidence on a timely basis.



Example 7.2.20

Decision to dispose of asset group after year-end

Following an indicator of impairment, ABC Corp. tests Asset Group for recoverability in December Year 1.

ABC's year-end is December 31, and at that point the probability of ABC selling Asset Group is remote. However, market conditions continue to deteriorate after year-end and in Year 2, before the issuance of the Year 1 financial statements, ABC decides to sell Asset Group and is actively seeking a buyer. The price for which Asset Group is being marketed provides evidence of impairment.

In performing the recoverability test, ABC considers all conditions that existed as of December 31, Year 1. At that point a possible sale of Asset Group was remote and the estimated future cash flows should reflect that fact – i.e. only a remote probability of selling the asset group and the expected proceeds. The estimated future cash flows should not presume the sale of Asset Group.

7.3 The primary asset



Excerpt from ASC 360-10

- > Estimates of Future Cash Flows Used to Test a Long-Lived Asset for Recoverability

35-31 Estimates of future cash flows used to test the recoverability of a long-lived asset (asset group) shall be made for the remaining useful life of the asset (asset group) to the entity. The remaining useful life of an asset group shall be based on the remaining useful life of the primary asset of the group. For purposes of this Subtopic, the primary asset is the principal long-lived tangible asset being depreciated or intangible asset being amortized that is the most significant component asset from which the asset group derives its cash-flow-generating capacity. The primary asset of an asset group therefore cannot be land or an intangible asset not being amortized.

35-32 Factors that an entity generally shall consider in determining whether a long-lived asset is the primary asset of an asset group include the following:

- Whether other assets of the group would have been acquired by the entity without the asset
- The level of investment that would be required to replace the asset
- The remaining useful life of the asset relative to other assets of the group. If the primary asset is not the asset of the group with the longest remaining useful life, estimates of future cash flows for the group shall assume the sale of the group at the end of the remaining useful life of the primary asset.



Question 7.3.10

What is the significance of the primary asset?

Interpretive response: Because the cash flows in the recoverability test are based on the use and eventual disposition of the asset group, it is necessary to determine the useful life of the asset group. That determination is made by reference to the useful life of the 'primary' asset – the principal depreciable (or amortizable) asset in the asset group (and on the entity's balance sheet) that drives its cash flow-generating capacity. [360-10-35-31]

As shown in the diagram, the recoverability test assumes that the cash flows from which the asset group's carrying amount will be recovered comprise:

- cash flows from operation during the useful life of the primary asset – 22 years in the diagram; and
- cash flows from disposing of the entire asset group at the end of the useful life of the primary asset – December 31, Year 23 in the diagram.

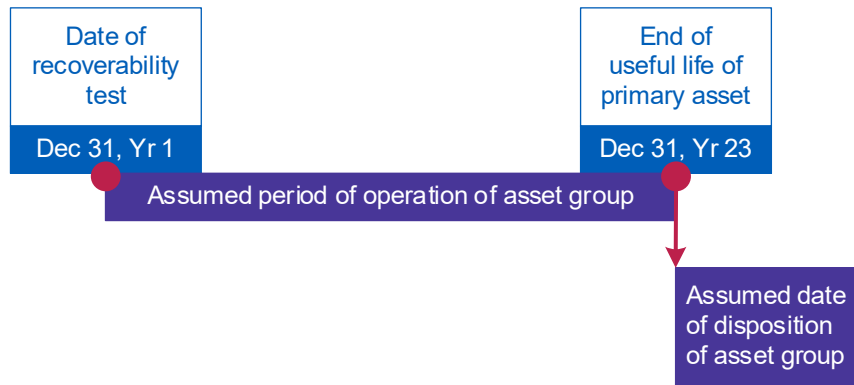

Question 7.3.20
How does an entity identify the primary asset?

Interpretive response: The primary asset is the principal depreciable (amortizable) asset in the asset group that drives its cash flow-generating capacity. It is not necessarily the asset with the longest remaining estimated useful life, and it cannot be land or an indefinite-lived intangible asset. Therefore, if the most significant asset that drives the asset group’s cash flows is an indefinite-lived intangible asset (e.g. a brand), then the entity chooses the asset next in line to be designated as the primary asset. [360-10-35-31]

In identifying the primary asset, management asks the following questions. [360-10-35-32]

- Would other assets in the asset group have been acquired in the absence of that asset? If ‘no’, that tends to support the asset being identified as the primary asset.
- What level of investment would be required to replace the asset? If significant investment would be required, that tends to support the asset being identified as the primary asset.
- What is the remaining useful life of the asset relative to other assets in the asset group? Although the primary asset does not always have the longest useful life, a longer useful life relative to other assets may indicate the other assets in the group support the long-term service potential of the longest-lived asset, rather than the reverse.



Example 7.3.10 Primary asset in an asset group

ABC Corp. is a technology company that sells components but earns most of its revenue from licensing technology. ABC is testing an asset group for recoverability that comprises the following long-lived assets with their respective remaining useful lives.

	Remaining useful life (years)
Office building	30
Factory	20
Equipment	10
IT equipment	3
Patent	15

ABC determines that the patent, which is the basis for its licensing agreements, is the primary asset of the asset group.

ABC made this determination based on the following.

- While the remaining useful life of the patent is less than the remaining useful lives of the office building and factory, the patent is the main driver of the asset group’s underlying cash flows.
- The value of the asset group is in the patent. The other assets would not have been acquired without it.
- The patent could not simply be replaced. The R&D investment required to develop a patent of similar importance to the asset group would be significant.

Because the office building and the factory will have significant remaining value at the end of the patent’s remaining useful life, ABC assumes the sale of the asset group at the end of 15 years when estimating cash flows for the recoverability test.



Example 7.3.20 Useful life is less than economic life

ABC Corp. has an asset group whose primary asset has an economic life of eight years. However, due to the risk of technological obsolescence, ABC expects to sell or replace the asset after five years. Therefore, ABC establishes a five-year useful (depreciable) life for the primary asset.

In this example, ABC incorporates into the recoverability test its expectations of the cash flows from operations during the five-year period. Similarly, it incorporates into the recoverability test its estimate of the cash flows from disposition of the asset group after five years, not eight years.



Question 7.3.30

How are future cash flows determined if the primary asset is nearing the end of its useful life?

Interpretive response: Notwithstanding that the primary asset is nearing the end of its useful life, the general principles in [Question 7.2.10](#) apply. The entity estimates its cash flows from operation to the end of the asset's useful life and estimates what the disposition value of the asset group will be at that date. The closer the primary asset is to the end of its useful life, the greater the significance of the disposition value in the recoverability test. [\[360-10-35-31\]](#)



Question 7.3.40

How are future cash flows determined if the entity intends to abandon the primary asset?

Interpretive response: Until the asset is actually abandoned (use has ceased), it is tested for impairment as an asset that is held and used. Estimates of future cash flows used to test the recoverability of the asset group should include only the future cash flows that are directly associated with and that are expected to arise as a direct result of the use and eventual disposition of the asset group. However, because the entity will not sell the asset, the cash flows from eventual disposition should not include those from a sale of the asset group.



Question 7.3.50

Are future cash flows adjusted to reflect revisions to the primary asset's remaining useful life or salvage value?

Interpretive response: Yes. If an entity revises the useful life or salvage value of the primary asset, it considers that revision in developing its estimate of future cash flows. It does not matter whether the revision to the useful life lengthens or shortens it, or whether the salvage value is increased or decreased.

Even though a revision to an asset's useful life or salvage value affects estimated future cash flows, Topic 360 requires an entity to recognize an impairment loss before revising depreciation estimates. The entity cannot avoid an impairment loss by prospectively adjusting an asset's useful life or salvage value estimate. See related [Question 9.3.30](#). [\[360-10-35-22\]](#)



Question 7.3.60

If an entity expects to settle a liability with the primary asset, what is the asset's remaining useful life?

Interpretive response: An entity that expects to transfer the asset group's primary asset to a lender in satisfaction of an obligation should revise the duration of the 'in use' cash flows to reflect that period of time. The disposition value of the asset group as of the expected disposition date is included in the estimated future cash flows of the asset group (see [Question 7.5.60](#)). [360-10-35-31]

If an entity is considering alternative courses of action, it should consider the likelihood of those possible outcomes. A probability-weighted approach may be useful in considering the likelihood of those possible outcomes (See [Question 7.2.30](#)). [Example 2 \(Case A\)](#) in Subtopic 360-10 illustrates the probability-weighted approach. [360-10-35-30, 360-10-55-23 – 55-29]



Question 7.3.70

Can the primary asset be a single customer relationship intangible asset?

Interpretive response: Yes, if it meets the criteria discussed in [Question 7.3.20](#). This means that: [360-10-35-31]

- the cash flows from operation will cover the remaining useful life of the customer relationship intangible asset that is on the balance sheet; and
- the entity will estimate the disposition value of the asset group at the end of the useful life of that customer relationship intangible asset.

Other customer relationships arising after that point cannot be used to extend the useful life of the asset group – i.e. the period over which cash flows from operation are considered, they will however be included in the cash flows. For a discussion about cash flows arising from customer relationships in general, see [Question 7.4.80](#).

7.4 Cash flows from operation



Excerpt from ASC 360-10

• > Estimates of Future Cash Flows Used to Test a Long-Lived Asset for Recoverability

35-30 Estimates of future cash flows used to test the recoverability of a long-lived asset (asset group) shall incorporate the entity's own assumptions about its use of the asset (asset group) and shall consider all available evidence. The assumptions used in developing those estimates shall be reasonable in relation

to the assumptions used in developing other information used by the entity for comparable periods, such as internal budgets and projections, accruals related to incentive compensation plans, or information communicated to others. However, if alternative courses of action to recover the carrying amount of a long-lived asset (asset group) are under consideration or if a range is estimated for the amount of possible future cash flows associated with the likely course of action, the likelihood of those possible outcomes shall be considered. A probability-weighted approach may be useful in considering the likelihood of those possible outcomes. See Example 2 (paragraph 360-10-55-23) for an illustration of this guidance.

35-31 Estimates of future cash flows used to test the recoverability of a long-lived asset (asset group) shall be made for the remaining useful life of the asset (asset group) to the entity. The remaining useful life of an asset group shall be based on the remaining useful life of the primary asset of the group. For purposes of this Subtopic, the primary asset is the principal long-lived tangible asset being depreciated or intangible asset being amortized that is the most significant component asset from which the asset group derives its cash-flow-generating capacity. The primary asset of an asset group therefore cannot be land or an intangible asset not being amortized.

35-32 Factors that an entity generally shall consider in determining whether a long-lived asset is the primary asset of an asset group include the following:

- a. Whether other assets of the group would have been acquired by the entity without the asset
- b. The level of investment that would be required to replace the asset
- c. The remaining useful life of the asset relative to other assets of the group. If the primary asset is not the asset of the group with the longest remaining useful life, estimates of future cash flows for the group shall assume the sale of the group at the end of the remaining useful life of the primary asset.

35-33 Estimates of future cash flows used to test the recoverability of a long-lived asset (asset group) that is in use, including a long-lived asset (asset group) for which development is substantially complete, shall be based on the existing service potential of the asset (asset group) at the date it is tested. The service potential of a long-lived asset (asset group) encompasses its remaining useful life, cash-flow-generating capacity, and for tangible assets, physical output capacity. Those estimates shall include cash flows associated with future expenditures necessary to maintain the existing service potential of a long-lived asset (asset group), including those that replace the service potential of component parts of a long-lived asset (for example, the roof of a building) and component assets other than the primary asset of an asset group. Those estimates shall exclude cash flows associated with future capital expenditures that would increase the service potential of a long-lived asset (asset group).

35-34 Estimates of future cash flows used to test the recoverability of a long-lived asset (asset group) that is under development shall be based on the expected service potential of the asset (group) when development is substantially complete. Those estimates shall include cash flows associated with all future expenditures necessary to develop a long-lived asset (asset group), including interest payments that will be capitalized as part of the cost of

the asset (asset group). Subtopic 835-20 requires the capitalization period to end when the asset is substantially complete and ready for its intended use.

35-35 If a long-lived asset that is under development is part of an asset group that is in use, estimates of future cash flows used to test the recoverability of that group shall include the cash flows associated with future expenditures necessary to maintain the existing service potential of the group (see paragraph 360-10-35-33) as well as the cash flows associated with all future expenditures necessary to substantially complete the asset that is under development (see the preceding paragraph). See Example 3 (paragraph 360-10-55-33). See also paragraphs 360-10-55-7 through 55-18 for considerations of site restoration and environmental exit costs.



Question 7.4.10

Do estimated future cash flows include income taxes?

Interpretive response: Topic 360 does not address whether estimates of future cash flows should include or exclude income taxes in the recoverability test. We believe an entity should make an accounting policy election of using either pre- or post-tax cash flows and that approach should be applied consistently over time unless facts or circumstances change.

An entity may decide to perform the recoverability test using pre-tax cash flows because certain tax-related consequences of the asset group are included in the entity's deferred tax assets and liabilities. And for consistency, deferred tax amounts related to the asset group are generally not included in its carrying amount for purposes of the recoverability test.

Alternatively, post-tax cash flows may be appropriate in some situations. For example, we believe an entity should use post-tax cash flows to test the recoverability of an asset group if its tax characteristics strongly influenced the entity's decision to invest in that asset – e.g. a direct investment in affordable housing because the investor's return depends significantly on income tax credits generated by the investment.



Question 7.4.20

Do estimated future cash flows include principal repayments of debt?

Interpretive response: No. Topic 360 specifically excludes interest charges from the recoverability test, it does not address principal repayments.

Excluding interest charges from the recoverability test precludes two entities with different capital structures from obtaining different answers in the recoverability test for assets that are essentially the same. Excluding principal repayments from the recoverability test is consistent with that approach.

Similarly, an entity should not include the debt as part of the carrying amount of the asset group (see [Question 5.3.30](#)).

As an exception, payments of principal (not interest) are included in the cash flows when this is consistent with how the carrying amount is determined; this is discussed in [Question 5.3.30](#).



Question 7.4.30

Do estimated future cash flows include lease payments?

Interpretive response: There are different types of payments that may be made to the lessor under a lease arrangement; the treatment of each payment in estimating future cash flows depends on whether the payment is of an operating or financing nature.

Applying Topic 842

For finance leases, cash outflows related to the interest and principal components of the lease liability are excluded in estimating future cash flows.

However, variable lease payments not included in the measurement of the finance lease liability – i.e. variable lease payments that do not depend on an index or rate – are included in estimating future cash flows.

For operating leases, we believe an entity may elect to either exclude or include the principal portion of the lease payments in estimating future cash flows, which is based on the entity's election about whether to include the operating lease liability in the carrying amount of the asset group. These approaches are discussed in more depth in [Question 5.3.40](#).

For short-term leases not recognized on the balance sheet, the related lease payments are included in estimating future cash flows.

These issues are discussed in more depth in Questions 6.5.10 to 6.5.30 of KPMG Handbook, [Leases](#).

Applying Topic 840

The following principles are based on the same logic noted above under Topic 842, although the amounts under the two standards (e.g. respective carrying amounts) are different.

- For capital leases, like for finance leases under Topic 842:
 - cash outflows related to the interest and principal components of the capital lease obligation are *excluded* in estimating future cash flows; and
 - variable lease payments not included in the measurement of the capital lease obligation are *included* in estimating future cash flows.
- For operating leases, all fixed and variable lease payments are included in estimating future cash flows.



Question 7.4.35

Do estimated future cash flows include sublease rental income?

Interpretive response: Yes, provided the entity (head lessee) is not relieved of its primary obligation to the head lessor when it enters into the sublease. (If the lessee is relieved of its primary obligation, it excludes sublease income from the estimated future cash flows because it no longer recognizes the right-of-use asset; see section 8.2.3 of KPMG Handbook, [Leases](#).)

For example, an entity (lessee) leases a manufacturing facility under an operating lease with a 10-year term, creating a right-of-use asset under Topic 842. At the end of Year 2 of the lease, the lessee decides it no longer needs the facility and subleases it for the remainder of the lease term. The lessee is not relieved of its primary obligation to the lessor under the head lease.

In this example, the lessee's recoverability test for the asset group containing the right-of-use asset:

- excludes lease payments to be made under the head lease as a consequence of the entity's accounting policy election to exclude the head lease liability from the carrying amount of the asset group (see [Questions 5.3.40](#) and [7.4.30](#)); and
- includes rental income to be received under the sublease.

Assuming other substantive actions by the entity before entering into the sublease do not trigger a reassessment of the entity's asset groups, entering into the sublease typically triggers a reassessment. This is because the sublease could indicate that there are separately identifiable cash flows for the underlying asset(s) (e.g. the right-of-use asset and related leasehold improvements) that are largely independent of the cash flows of other assets and liabilities that were grouped together with the right-of-use asset (see [Question 3.3.110](#)).

Question 6.5.60 of KPMG Handbook, [Leases](#), includes a broader discussion about reassessing asset groups when an entity plans to significantly change how it uses a right-of-use asset that is part of a larger asset group.



Question 7.4.40

Do estimated future cash flows include payments related to capitalized asset retirement costs?

Interpretive response: No. Topic 360 specifically requires the related cash outflows to be excluded from the estimated future cash flows as part of the recoverability test. See [Question 5.3.60](#) for a more in-depth discussion about AROs. [360-10-35-18]



Question 7.4.50

Do estimated future cash flows include the cost of maintaining and replacing assets?

Interpretive response: It depends on the asset and the type of expenditure. The cash flows from operation of the asset group are based on the useful life of the primary asset (see [Question 7.3.10](#)). Therefore, the replacement of the primary asset is not contemplated in estimating future cash flows.

The following cash flows are included: [\[360-10-35-33\]](#)

- the cost of replacing components of the primary asset – e.g. replacing a furnace in a factory that is the primary asset;
- the cost of replacing assets (and components thereof) that are not the primary asset – e.g. replacing a warehouse that is part of the asset group but not the primary asset; and
- the cost of maintaining the assets in the asset group, including both routine maintenance (e.g. cleaning) and periodic major maintenance (e.g. resurfacing a road).

However, the inclusion of these cash flows is subject to the overriding principle that they must be based on the asset group’s current physical output and cash flow generation capacity. For example, if an entity plans to increase its factory capacity by a third by building a new facility, that expenditure is not included in estimating future cash flows – nor is the increase in cash inflows that the entity expects to generate from increased sales. [\[360-10-35-33\]](#)

In many cases, an expenditure will include an element of service capacity improvement simply because of the natural process of technological advancement that is unrelated to a conscious effort to increase the service potential of the asset group. We believe an entity should apply judgment to assess the extent to which such expenditure (and the related effect on cash inflows) should be included.

In summary, all capital expenditures required to maintain the current service potential – other than the replacement of the primary asset – of an asset group should be considered (often referred to as ‘maintenance’ capital expenditures), whereas all capital expenditures that expand the service potential of the asset group should not be included (‘growth’ capital expenditures).



Question 7.4.60

Do estimated future cash flows include the cost of completing assets under development?

Interpretive response: If an asset group is under development, the estimated future cash flows are based on the expected service potential of the asset group once development is substantially complete. The cash flows include all expenditures needed to complete the development of the asset group, including interest charges that will be capitalized. [\[360-10-35-34\]](#)

If a long-lived asset *within* an in-use asset group is under development, the estimates of future cash flows include the cash flows necessary to substantially complete the asset (and subsequent maintenance) such that the current, in-use service potential of the asset group is maintained; this is consistent with the concepts discussed in [Question 7.2.10](#). [360-10-35-35]

Example 3 in Topic 360 illustrates the recoverability test for an asset group under development.



Excerpt from ASC 360-10

• > Example 3: Estimates of Future Cash Flows Used to Test an Asset Group for Recoverability

55-33 A long-lived asset that is under development may be part of an asset group that is in use. In that situation, estimates of future cash flows used to test the recoverability of that group shall include the cash flows associated with future expenditures necessary to maintain the existing service potential of the group as well as the cash flows associated with future expenditures necessary to substantially complete the asset that is under development (see paragraph 360-10-35-35).

55-34 An entity engaged in mining and selling phosphate estimates future cash flows from its commercially minable phosphate deposits in order to test the recoverability of the asset group that includes the mine and related long-lived assets (plant and equipment). Deposits from the mined rock must be processed in order to extract the phosphate. As the active mining area expands along the geological structure of the mine, a new processing plant is constructed near the production area. Depending on the size of the mine, extracting the minable deposits may require building numerous processing plants over the life of the mine. In testing the recoverability of the mine and related long-lived assets, the estimates of future cash flows from its commercially minable phosphate deposits would include cash flows associated with future expenditures necessary to build all of the required processing plants.



Question 7.4.70

Do estimated future cash flows consider the utilization of current excess capacity?

Interpretive response: It depends. We believe the cash inflows and cash outflows related to the increased capacity utilization should be included in the estimated future cash flows if:

- the excess capacity is part of the existing service potential of the asset group;
- the excess capacity can be utilized without significant capital expenditure;
- and

- the underlying assumptions that support the cash flows are consistent with the entity's other forecasts and assumptions (see [Question 7.2.50](#)).

For example, a factory is currently operating at 80% capacity, but the entity expects demand for its products to increase over the next two to three years, bringing capacity usage to 95%. As capacity usage increases, the entity will receive greater cash inflows from increased sales and incur greater cash outflows for maintenance and labor costs, but no additional capital expenditure will be required. In this case, the entity should include the additional cash flows, assuming that its increased production, sales and related assumptions are consistent with its other forecasts and assumptions.



Question 7.4.80

To what extent do estimated future cash flows include cash inflows from new customers?

Interpretive response: Estimated future cash flows include cash inflows generated by new customers to the extent those cash inflows are supported by the existing service potential of the asset group. To the extent it is necessary to increase the asset group's service potential to generate new customers (e.g. through additional capital expansion), those cash inflows are not included. This is the case even if the primary asset is the customer relationship (see [Question 7.3.70](#)).

See also [Question 7.4.70](#), which discusses the utilization of current excess capacity.



Question 7.4.90

Do estimated future cash flows include the benefit of unrecognized intangible assets?

Interpretive response: Yes. The estimated future cash flows include all cash flows related to the operation and ultimate disposal of the asset group. This is regardless of whether the underlying assets contributing to those cash flows are recognized on the balance sheet.

The following are examples of assets that were internally generated by an entity and are not recognized on its balance sheet.

- Customer relationships: Cash inflows include the increased sales from maintaining a good relationship with a certain class of customers, but also take into account the effect of promotions and discounts as part of maintaining that relationship.
- Brands: Cash outflows include the costs of advertising and other efforts to enhance brand awareness, and cash inflows include the resulting increase in sales.

However, care is required to ensure the cash flows are based on the existing service potential of the asset group (see [Question 7.2.10](#)). [360-10-35-33]



Question 7.4.100

Do estimated future cash flows include the benefit of goodwill related to the reporting unit in which the asset group resides?

Background: Goodwill is tested for impairment at the reporting unit level. It is included in the carrying amount of an asset group only if the asset group is or includes a reporting unit. See [Question 5.3.10](#).

Interpretive response: Yes. An entity estimates future cash flows without regard to whether it benefits from the effect of goodwill that will be tested for impairment at the reporting unit level – i.e. no adjustments are made to strip out the cash flow premium that might be attributed to the goodwill.



Question 7.4.110

How are shared costs incorporated into estimated future cash flows?

Interpretive response: The estimated future cash flows include all cash outflows necessary to support the cash inflows of the asset group. Because the asset group is being tested as a stand-alone unit of account, it follows that the cash outflows include those shared costs or costs incurred by other functions on behalf of the asset group that the asset group would need to incur on a stand-alone basis. It is not relevant whether the entity explicitly allocates those costs to the asset group. This precludes two entities with different internal cost allocation policies from obtaining different answers in the recoverability test for assets and operations that are essentially the same.

An entity should evaluate intercompany charges for shared costs for reasonableness and completeness if those charges are included in the estimated future cash flows as a surrogate for the costs that the group would incur if it were an independent operation. Cost allocations that leave significant amounts of unallocated costs at the corporate level may indicate that the allocation is neither reasonable nor complete.

An entity should develop an overall entity-wide methodology for apportioning shared costs among the benefited groups to ensure consistency. For example, apportioning cash outflows related to pension costs based on headcount may be reasonable.



Question 7.4.120

Are estimated future cash flows used in the recoverability test adjusted for the benefit of trade names and IP that reside outside the asset group?

Background: A trade name or intellectual property (IP) may reside outside of the asset group, either:

- within the reporting entity as an enterprise asset (see [section 7.7](#)); or
- outside the reporting entity (i.e. in a different part of a consolidated group).

If the trade name (or brand) attracts premium pricing, the asset group benefits. Similarly, the asset group benefits from the sale of products derived from using IP with no intercompany charge for its use.

Interpretive response: In our experience, there is diversity in practice in performing the recoverability test.

- **Charge included.** We believe it is preferable for the estimated future cash flows to include a hypothetical intercompany charge for use of the trade name or IP. This ensures the cash flows include all cash outflows required to support the estimated cash inflows.
- **No charge included.** As an alternative, we believe it is acceptable for an entity not to include a hypothetical intercompany charge if it is not actually charged. As a consequence, there is a possibility that the asset group will continue to pass the recoverability test when it would have failed if there had been a hypothetical intercompany charge.



Question 7.4.130

Do estimated future cash flows take into account hedging instruments related to long-lived assets?

Interpretive response: Ordinarily, the expected cash flows of a derivative hedging instrument are excluded in determining whether an asset related to the hedged transaction is impaired because the derivative is a separate asset or liability (see [Question 5.3.90](#)). [815-30-35-42]

However, the SEC staff has specific guidance for entities with oil- and gas-producing activities that apply the full cost method of accounting. In this situation, the prices to be received after taking into account cash flow hedging arrangements are used to calculate the current price of the quantities of the future production of oil and gas reserves covered by the hedges as of the reporting date. The current price is then used to determine whether the capitalized cost of the oil- and gas-producing entity exceeds the full cost limitation. [932-360-S99-2]

For further discussion, see section 10.4 of KPMG Handbook, [Derivatives and Hedging](#).



Question 7.4.140

How are future cash flows estimated when government credits classified as inventory are distributed to owners instead of being sold?

Background: Joint Venture (JV) owns and operates a facility to generate wind power. Historically the JV generated operating cash flows from the sale of both electricity generated by the facility and the Renewable Energy Credits (RECs) it received from a regulatory authority for producing renewable energy. The RECs are classified as inventory, which is consistent with industry practice.

Historically, the RECs have been sold in the market and the resulting cash flows have been included in the recoverability test. However, a change in approach means that future RECs will be distributed directly to the owners based on their respective ownership percentages.

As a result, JV will generate less cash flows. Instead, JV's owners will generate cash flows by either selling the RECs or otherwise using them – e.g. to demonstrate that energy used was produced from renewable sources resulting in lower cash outflows for RECs, the owners would have to purchase in the market.

Interpretive response: In the background example, we believe the hypothetical cash flows that would be generated by JV if the inventory was converted to cash before distribution should be included in the estimated future cash flows. The hypothetical cash flows should be measured with reference to the market price of the RECs on the date of distribution.

This conclusion means that two entities with essentially the same assets and operations will achieve the same result in the recoverability test regardless of their approach to distributions.



Question 7.4.150

Does the general partner include limited partners' preferred return as a cash outflow when it consolidates the partnership?

Interpretive response: No. We believe that an entity that serves as the general partner in, and consolidates, a limited partnership in which the limited partners are entitled to a guaranteed minimum or preferential return should not include the preferred returns as cash outflows in estimating future cash flows.

The guaranteed minimum or preferential return is analogous to a cost of financing. Therefore, excluding the limited partners' preferred returns follows the general principles of the recoverability test (see [Question 7.2.10](#)).

If the entity applies the equity method of accounting to its investment, it should test the investment for impairment under Topic 323 instead of Topic 360. See section 5.5 of KPMG Handbook, [Equity method of accounting](#).



Question 7.4.160

Do estimated future cash flows of a mono-line insurance entity include investment cash flows if the asset group is the entire entity?

Interpretive response: Yes. Because investment cash flows are an integral component of insurance product pricing, an insurance entity includes investment cash flows in the recoverability test when it evaluates a long-lived asset for impairment at the entity level.



Question 7.4.170

Do estimated future cash flows include insurance recoveries for property damage?

Interpretive response: No. Topic 360 specifically requires that the estimates of future cash flows used in the recoverability test be directly associated with, and expected to arise as a direct result of, the use and eventual disposition of the asset. Insurance recoveries for property losses are excluded because they are not directly associated with the use of the asset – i.e. they are not a source of operating cash flows for purposes of recovering the carrying amount of the asset. [360-10-35-29]

However, based on the principles discussed in [Question 7.4.50](#), the expenditure necessary to repair the damaged asset(s) is included in the estimated future cash flows; this is because it is needed to maintain the existing service potential of the asset group. Therefore, damage to assets may result in the related asset group being impaired regardless of insurance coverage.

Separately, the entity may recognize an insurance recovery of a loss or costs incurred when the recovery is probable and reasonably estimable. Any insurance proceeds in excess of the loss or costs incurred is a gain contingency and is recognized only when all contingencies have been resolved, which generally happens when the claim is settled. [450-30-25-1]

This accounting applies the guidance on involuntary conversions by analogy: a loss arising from the destruction or damage of a nonmonetary asset is recognized separately from the related insurance recovery (monetary asset) and any resulting gain. [610-30-25-2 – 25-3]

See also related [Question 8.4.50](#), which discusses the writeoff of a damaged asset even if the carrying amount of the asset group is otherwise recoverable.



Question 7.4.180

Do estimated future cash flows include business interruption insurance recoveries?

Background: During periods in which a damaged asset is repaired or replaced, many entities will experience a decline in cash inflows from operations (and potentially an increase in cash outflows); this is in addition to property losses (see [Question 7.4.170](#)). An entity may be covered by business interruption insurance that is intended to reimburse operating cash flows or net profits during the period in which operations are curtailed – i.e. the insurance varies based on costs incurred/revenues lost.

Interpretive response: To the extent that a recovery is probable and estimable, we believe such recoveries should be included in estimating future cash flows:

- if the related repair or replacement costs are included in cash outflows; but
- only up to the amount of such cash outflows.

For example, if a hotel property owner is unable to rent rooms for a period of time due to hurricane damage and has business interruption insurance, the estimated future cash flows for the asset may be negative during the repair period. However, the entity should not project a net cash inflow if the business interruption insurance proceeds are expected to be greater than the estimated cash outflows. This means that despite an expectation of net cash inflows, an impairment loss may still be incurred.

This accounting reflects the fact that the insurance is a recovery of operating and repair costs (i.e. reduction in cash outflows) for purposes of recovering the carrying amount of the repaired/replaced asset. However, we do not believe this approach should allow a margin over and above the recovery of costs. Instead, ‘excess’ recoveries (a gain contingency) will be reflected in the income statement when realized or realizable. [\[450-30-25-1\]](#)

7.5 Cash flows from disposition



Question 7.5.10

Is it always necessary to estimate future cash flows from disposition?

Interpretive response: No. If the estimated future cash flows from operation are sufficient to show that the carrying amount of the asset group is recoverable, including additional cash inflows from eventual disposition would not change that outcome.

However, depending on the size of the excess of cash flows from operation over the carrying amount, an entity needs to ensure that a possible net cash outflow on disposition would not cause the asset group to fail the recoverability

test – e.g. because of exit costs related to environmental contamination (see [section 7.6](#)).



Question 7.5.20

How are future cash flows from disposition estimated?

Interpretive response: The assumed disposition of the asset group at the end of the useful life of the primary asset is often the assumed sale of those assets. The assumed sale proceeds should be an exit value from a market participant perspective based on the assets and liabilities of the asset group and its service potential existing at the assumed disposition date.

If the asset group is a discrete tangible asset group (e.g. production line), eventual disposition would be a sale of the tangible asset group at the end of its useful life and is commonly represented by salvage value.

If an orderly or piecemeal disposition of the asset group (e.g. plant assets) is most likely, the net realizable value for each asset should be determined using market inputs for orderly sales of comparable assets, less selling costs.

If the asset group is a business, often the valuation method used is to estimate the sale price of the asset group assuming its continued operation as a viable business (see [Question 7.5.40](#)).

Note: In referring to a 'business', this does not imply the definition of a business in Topic 805.



Question 7.5.30

Do estimated future cash flows from disposition include income taxes?

Interpretive response: Topic 360 does not address whether estimates of future cash flows should include or exclude income taxes in the recoverability test. As noted in [Question 7.4.10](#) in the context of cash flows from operation, we believe an entity should make an accounting policy election of using either pre- or post-tax cash flows and that approach should be applied consistently.

If an entity elects to use pre-tax cash flows, no income taxes are considered on the disposition value itself – i.e. differences between the tax basis of the assets (at disposition) and the disposition value are not taken into account.



Question 7.5.40

How are future cash flows from disposition estimated when the asset group is a business?

Interpretive response: If the asset group is a business, care is required that the disposition value does not reflect any increase in service potential of the business (see [Question 7.2.10](#)). In this regard disposition value differs from fair value, which captures the potential future upside of a business (see [chapter 8](#)).

Maintaining the existing service potential does not imply zero growth of the asset group; instead, the prospect of growth is limited by the existing service potential. For example, if the asset group is a manufacturing line, long-term growth would be limited to the remaining free capacity of the manufacturing line.

With respect to the long-term growth rate method and exit multiple methodologies (two common methodologies), an adjustment may be needed to the disposition value calculation to take into account that capital expenditures in the assumed period of operation (see [section 7.4](#)) excluded expenditure that would extend the useful life of the asset group beyond the useful life of the primary asset. The adjustment considered in the disposition value calculation takes into account this capital expenditure 'backlog'.

The selection of the appropriate methodology to determine the disposition amount depends on the specific facts and circumstances of the asset group.



Question 7.5.50

If an asset group includes all of the entity's long-lived assets, do estimated future cash flows from disposition assume disposal of the entire business?

Interpretive response: Yes. When an asset group contains all of the entity's long-lived assets, its disposal represents the sale of the business. This means that disposition value includes all value associated with the entity, even if not recorded on the balance sheet.

For example, if the asset group's primary asset is software but the entity's most valuable asset is its unrecorded brand, the disposition value includes the value from the sale of the brand.

See related [Question 7.4.90](#) on including the benefit of unrecognized intangible assets in cash flows from operation.



Question 7.5.60

If an entity expects to settle a liability with the primary asset, what is the asset's disposition value?

Interpretive response: If the primary asset is expected to be used to settle a liability, the asset group's disposition value is the expected fair value of the asset group at the end of its useful life. It is not appropriate to use the current carrying amount of the nonrecourse obligation.

For example, an entity borrows \$1,000 to purchase real property; the borrowing is nonrecourse. Several years later, the property has a fair value of \$600, while the balance due to the lender is \$800. The disposition value of the property is \$600 (its expected fair value) and not the expected settlement value of \$800.

7.6 Site restoration and environmental exit costs



Excerpt from ASC 360-10

- > Treatment of Certain Site Restoration and Environmental Exit Costs when Testing a Long-Lived Asset for Impairment

55-1 The following guidance demonstrates the consideration of restoration and environmental exit costs when testing a long-lived asset for **impairment**. Paragraphs 360-10-35-18 through 35-19 also provide guidance for such testing for assets subject to asset retirement obligations.

55-2 For certain assets covered by this Subtopic, costs for future site restoration or closure (environmental exit costs) may be incurred if the asset is sold, is abandoned, or ceases operations. Environmental exit costs within the scope of this Subsection include:

- Asset retirement costs recognized pursuant to Subtopic 410-20
- Asset retirement costs that have not been recognized because the obligation has not been incurred
- Certain environmental remediation costs that have not yet been recognized as a liability pursuant to Subtopic 410-30.

55-3 Pursuant to Subtopic 410-20, asset retirement costs may be incurred over more than one reporting period. For example, the liability for performing certain capping, closure, and postclosure activities in connection with operating a landfill is incurred as the landfill receives waste.

55-4 The related cash flows, if any, might not occur until the end of the asset's life if the asset ceases operations, or they might be deferred indefinitely as long as the asset is not sold or abandoned.

55-5 The issue is whether the cash flows associated with environmental exit costs that may be incurred if a long-lived asset is sold, is abandoned, or ceases operations should be included in the undiscounted expected future cash flows used to test a long-lived asset for recoverability under this Subtopic.

55-6 For environmental exit costs that have not been recognized as a liability for accounting purposes, whether those environmental exit costs shall be included in the undiscounted expected future cash flows used to test a long-lived asset for recoverability under this Subtopic depends on management's intent with respect to the asset. Pursuant to this Subtopic, if management's intent contemplates alternative courses of action to recover the carrying amount of the asset or if a range is estimated for the amount of possible future cash flows, the likelihood of those possible outcomes shall be considered. Examples of management's intent and the corresponding treatment of the environmental exit costs in this Subtopic's recoverability test are described below. (Environmental remediation costs discussed in certain of these cases refer to environmental remediation costs that have not yet been recognized as a liability pursuant to Subtopic 410-30.) This paragraph illustrates the guidance in paragraphs 360-10-35-29 through 35-35 on estimating future cash flows used to test a long-lived asset for recoverability.

- > Environmental Exit Costs that Shall Be Excluded from this Subtopic's Recoverability Test

55-7 The following guidance demonstrates the consideration of restoration and environmental exit costs when testing a long-lived asset for impairment. In all of the following situations, environmental exit costs would be excluded from this Subtopic's recoverability test.

- • > Management Intends to Operate Asset, Future Cash Flows Exceed Carrying Amount, and No Expectation of Cash Outflow in Disposition

55-8 Management intends to operate the asset for at least the asset's remaining depreciable life, the sum of the undiscounted future cash flows expected from the asset's use during that period exceeds the asset's carrying amount including any associated goodwill, and management has no reason to believe that the asset's eventual disposition will result in a net cash outflow.

- • > Management Expects to Operate Asset, Asset Generating Positive Cash Flows, Profitability Expected to Continue, and No Constraints on Economic Life

55-9 Management expects to operate the asset indefinitely and has the ability to do so, the asset is generating positive cash flows, management's best information indicates that the asset will continue to be profitable in the future, and there are no known constraints to the asset's economic life. This Subtopic's recoverability test shall include the future cash outflows for repairs, maintenance, and capital expenditures necessary to obtain the future cash inflows expected to be generated by the asset based on its existing service potential.

- • > Asset Has Finite Life but Remediation Costs Only Incurred if Asset Sold or Abandoned

55-10 The asset has a finite economic life, but environmental remediation costs will only be incurred if the asset is sold or abandoned. At the end of the asset's life, management intends either to close the asset permanently because the costs of remediating the asset exceed the proceeds that likely would be received if the asset were sold or, alternatively, to idle the asset by reducing production to a minimal or nominal amount. (Although the environmental remediation costs are excluded from this Subtopic's recoverability test, the recoverability test shall incorporate the entity's own

assumptions about its use of the asset. That is, the recoverability test shall consider the likelihood of the alternative courses of action [either closing or idling the asset] and the resulting cash flows associated with those alternative courses.)

• • > Management Expects to Sell Asset and Remediation Costs Not Required

55-11 Management expects to sell the asset in the future, and the asset's sale will not require the environmental remediation costs to be incurred. (Although the environmental remediation costs are excluded from this Subtopic's recoverability test, the fair value of the asset is likely to be affected by the existence of those costs. The diminished fair value shall be considered in estimating the cash flows expected to arise from the eventual sale of the asset.)

• > Environmental Exit Costs that Shall Be Included in this Subtopic's Recoverability Test

55-12 The following guidance demonstrates the consideration of restoration and environmental exit costs when testing a long-lived asset for impairment. In all of the following situations, environmental exit costs would be included in this Subtopic's recoverability test.

• • > Management Expects Remediation Costs to Be Incurred but Uncertainties Exist in Application of Laws

55-13 Management expects to take a future action related to the asset that may cause the environmental remediation costs to be incurred. However, uncertainties or inconsistencies exist in how the related laws or regulatory requirements are applied. Management estimates, based on the weight of the available evidence, a 60 percent chance that the remediation costs will not be incurred and a 40 percent chance that those costs will be incurred. Pursuant to this Subtopic, other situations may exist in which cash flows are estimated using a single set or best estimate of cash flows.

• • > Useful Life Limited and then Asset Disposition Required

55-14 The useful life of the asset is limited as a result of any of the following:

- a. Actual or expected technological advances
- b. Contractual provisions
- c. Regulatory restrictions.

Also, when the asset's service potential has ended, management will be required to dispose of the asset under paragraph 360-10-55-16 or 360-10-55-17.

• • > Continuing Losses May Require Asset Disposition

55-15 The asset has a current period cash flow loss from operations combined with a projection or forecast that anticipates continuing losses. Management expects the asset to achieve profitability in the future but uncertainty exists about management's ability to fund the future cash outflows up to the time that net cash inflows are expected from the asset's use. In the event of a forced liquidation, management would likely dispose of the asset under the following paragraph or paragraph 360-10-55-17.

• • > Intent to Abandon or Close an Asset

55-16 Management intends to abandon or close the asset in the future, and the event of abandonment or closure will cause the environmental remediation costs to be incurred.

• • > Future Sale Will Require Remediation Costs to Be Incurred

55-17 Management intends to sell the asset in the future, and the applicable laws, regulations, or interpretations thereof require that appropriate environmental remediation (not within the scope of Subtopic 410-20) occur in connection with the sale.

• • > Management Expects to Operate Asset and Retirement Costs to Be Incurred over Its Life

55-18 Management expects to operate the asset for the remainder of its useful life. Related asset retirement costs are incurred over the life of the asset (for example, the operation of a landfill). Estimated cash flows associated with the asset retirement costs yet to be incurred and recognized shall be included in this Subtopic's recoverability test.



Question 7.6.10

Do estimated future cash flows include exit costs to remediate environmental contamination?

Background: Future cash flows that constitute environmental exit costs, which are in the scope of the illustrative guidance in Topic 360, may arise from the following:

- asset retirement costs that have been recognized and a corresponding liability recognized; see [Question 5.3.60](#) for guidance;
- asset retirement costs that have not been recognized because the related obligation has not yet been incurred; and
- environmental remediation costs not yet recognized as a liability.

Interpretive response: It depends. Whether environmental exit costs are included in the recoverability test cash flows depends on management's intent with respect to the asset group. If management is contemplating alternative courses of action to recover the carrying amount of the asset, or if a range is estimated for the amount of possible future cash flows, the likelihood of those possible outcomes should be considered. [\[360-10-55-6\]](#)

Topic 360 include examples of situations in which an entity should include or exclude environmental exit costs in estimating future cash flows, which are summarized in the following table. [\[360-10-55-7 – 55-18\]](#)

Included	Excluded
<ul style="list-style-type: none"> — Management expects remediation costs to be incurred but uncertainties exist in application of laws; in this case, the entity uses probability-weighted cash flows (see Question 7.2.30). — Useful life limited and then asset disposition required. — Continuing losses may require asset disposition; although not mentioned in the guidance, the entity may need to use probability-weighted cash flows (see Question 7.2.30). — Intent to abandon an asset. — Future sale will require remediation costs to be incurred before the sale. — Management expects to operate asset and retirement costs (not yet recognized) will be incurred over its life. 	<ul style="list-style-type: none"> — Management intends to operate asset, future cash flows from operation exceed carrying amount, and no expectation of net cash outflow on disposition. — Management expects to operate asset, asset generating positive cash flows, profitability expected to continue, and no constraints on economic life. — Asset has finite life, but remediation costs only incurred if asset sold or abandoned (which is not management’s intent). — Management expects to sell asset and remediation costs not required.

The final example of environmental exit costs indicates that the costs are excluded from the estimated future cash flows because those costs are not required as a condition of sale. However, the negative environmental status of the asset might nonetheless be relevant if the asset’s fair value – used in determining disposition value (see [Question 7.5.20](#)) – would be affected.

7.7 Enterprise assets

Question 7.7.10
How is the recoverability test performed for an asset group that includes an enterprise asset?

Background: An enterprise asset is an asset that supports the revenue-producing activities of two or more asset groups. It might also be called a corporate-support asset. An example of an enterprise asset is a trade name that supports the revenue generated by various product groups. An enterprise asset results in an additional (higher-level) asset group being identified, comprising the enterprise asset together with the lower-level asset groups to which it relates. See discussion in [section 3.3.40](#).

Interpretive response: To determine the cash flows available to recover the enterprise asset, an entity first assesses impairment at the lower-level asset groups that benefit from the support asset and recognizes any required

impairment losses. If there is no impairment indicator within any of the lower asset groups, it is not necessary to separately test the recoverability of each lower-level asset group before testing the enterprise asset.

We believe the entity can perform the recoverability test for the enterprise asset in one of two ways. Both approaches will produce the same result.

Global approach

Under the global approach, an entity adds the carrying amounts of the lower-level asset groups to the carrying amount of the enterprise asset and compares that aggregate carrying amount to the sum of estimated future cash flows of the lower-level asset groups and the cash flows related to the enterprise asset.

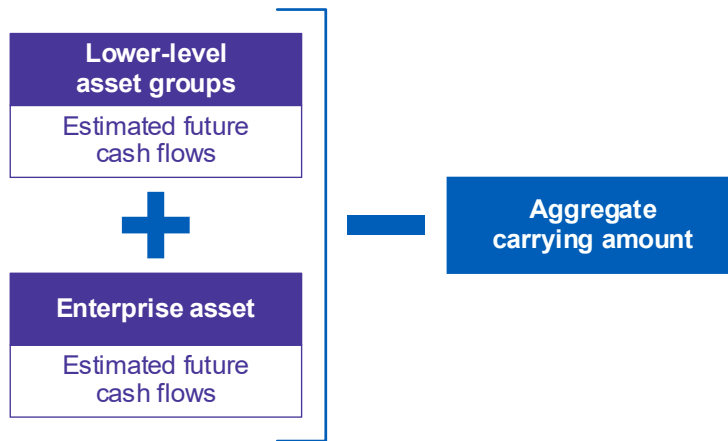

Residual approach

Under the residual approach, an entity compares the carrying amount of the enterprise asset with the sum of the remaining cash flows available from the lower-level groups – i.e. the entity reduces the estimated future cash flows by the carrying amount of the assets in the lower-level groups – and the cash flows related to the enterprise asset.

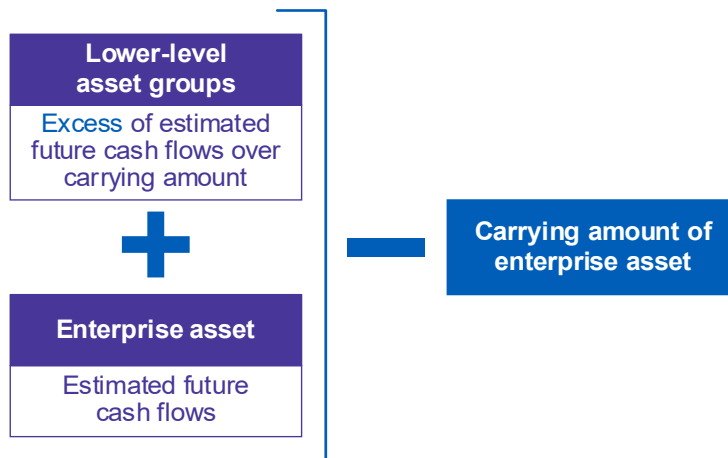

An entity should test an enterprise asset for recoverability using only the available cash flows from the lower-level asset groups that benefit from or fund the costs of the asset the entity is testing – plus any cash flows attributable to

the enterprise asset itself. For example, if a headquarters building supports the operations of only one of an entity's three subsidiaries, the entity should use only the cash flows of the asset groups within the supported subsidiary to test the carrying amount of the building for recoverability (in addition to any cash flows attributable to the building).

In certain cases, a retailer may have multiple flagship stores that are used to raise brand awareness in different geographic regions. In this case, the retailer should consider if it should test each flagship store for recoverability using the available cash flows from the stores that are located only within the geographic region that the flagship store is set up to benefit (in addition to any cash flows attributable to the flagship store).



Example 7.7.10 Recoverability test for an enterprise asset

ABC Corp. has two asset groups (AG-A and AG-B) supported by a corporate headquarters (HQ) with a carrying amount of \$400 and a fair value of \$250.

Following an indicator of impairment, ABC tests AG-A for recoverability. As a result of the recoverability test, AG-A is identified as impaired (the estimated future cash flows of \$500 do not support the carrying amount of \$750) and ABC recognizes an impairment loss of \$350 (\$400 - \$750); see [chapter 8](#).

	AG-A	AG-B	Total
Estimated future cash flows	\$ 500	\$ 1,750	\$ 2,250
Carrying amount	(750)	(1,400)	(2,150)
Available cash flows	\$(250)	\$ 350	\$ 100
Fair value	\$ 400	\$ 1,600	\$ 2,000

ABC has also identified events and circumstances that indicate it needs to test HQ for recoverability. This means that it needs to consider the recoverability of both lower-level asset groups.

ABC first recognizes the AG-A impairment loss of \$350, which reduces the carrying amount of AG-A to \$400. Then ABC applies either the global approach or the residual approach to test HQ for recoverability. For simplicity, this example assumes that no cash outflows are associated with HQ.

	Global approach	Calculation / conclusion
Estimated future cash flows of AG-A + AG-B + HQ (zero)	\$2,250	See above table
Less Aggregate carrying amount of AG-A + AG-B + HQ	(2,200)	(\$2,150 - \$350 impairment) + \$400
Available cash flows	\$ 50	No impairment

	Residual approach	Calculation / conclusion
Excess of estimated future cash flows over carrying amount for AG-A + AG-B plus estimated future cash flows of HQ (zero)	\$ 450	(\$500 - \$400 post-impairment) + \$350 +\$0
Less carrying amount of HQ	(400)	Per above
Available cash flows	\$ 50	No impairment

Note: If ABC had tested HQ for recoverability before recognizing the impairment loss for AG-A, it would have incorrectly concluded that HQ was impaired. Applying the global approach (for example), it would have compared cash flows of \$2,250 to the pre-impairment aggregate carrying amount of \$2,550.

8. Fair value measurement

Detailed contents

Item significantly updated in this edition:

8.1 How the standards work

8.2 Principles of fair value measurement

- 8.2.10 Overview
- 8.2.20 Establish parameters
- 8.2.30 Select appropriate valuation approach(es) and technique(s)
- 8.2.40 Determine inputs to measure fair value
- 8.2.50 Highest and best use

8.3 Reporting units

- 8.3.10 Overview
- 8.3.20 Valuation premise: enterprise vs equity value
- 8.3.30 Tax structure
- 8.3.40 Market approach
- 8.3.50 Income approach
- 8.3.60 Selecting valuation techniques
- 8.3.70 Reconciling fair value to market capitalization

Questions

- 8.3.10 Can an entity combine reporting units in measuring fair value?
- 8.3.20 What is the difference between an enterprise value and an equity value?
- 8.3.30 What adjustments are made to enterprise value to derive equity value? #
- 8.3.40 Does the valuation premise (enterprise vs equity value) affect the impairment conclusion?
- 8.3.50 How does the valuation premise affect the carrying amount of the reporting unit for impairment purposes?
- 8.3.60 What is the difference between a taxable and a nontaxable transaction?
- 8.3.70 What tax structure does an entity assume in measuring the fair value of a reporting unit?
- 8.3.80 What are key differences between an assumed taxable vs nontaxable structure?

- 8.3.90 If market multiples are derived using the guideline public companies method, what are the key factors that influence the measurement?
- 8.3.100 Can an entity use forward-looking market multiples when markets are distressed?
- 8.3.110 If fair value is based on an entity's share price, how is an MPAP supported?
- 8.3.120 How does an entity evaluate an increase in MPAP in distressed markets?
- 8.3.125 If market multiples are derived using the comparable transactions method, what are the key factors that influence the measurement?
- 8.3.130 If fair value is based on discounted cash flows, what are the key factors that influence the measurement?
- 8.3.140 How are management's cash flow projections adjusted to reflect market participant assumptions?
- 8.3.150 What forecast period is used for estimated future cash flows?
- 8.3.160 How is the discount rate determined in applying the discounted cash flow method?
- 8.3.170 What present value techniques are commonly used to discount forecasted cash flows?
- 8.3.180 Can cash flows be discounted using a risk-free rate?
- 8.3.190 How is the present value of the residual cash flows determined in applying the discounted cash flow method?
- 8.3.200 How does an entity adjust its discounted cash flow models to reflect distressed economic conditions?
- 8.3.210 If an entity expects conditions after the measurement date to change, does it reflect that expectation in measuring fair value?
- 8.3.215 When is the direct capitalization method used?
- 8.3.220 What constraints does an entity face when selecting valuation techniques?
- 8.3.230 Can multiple valuation approaches or techniques be used to fair value the same unit of account?
- 8.3.240 Should an entity reconcile the fair value of its reporting units to its market capitalization?
- 8.3.250 Can an entity use an average share price when reconciling to market capitalization?
- 8.3.255 If an average share price is used when reconciling to market capitalization, can an entity consider share prices after the measurement date?

- 8.3.260 Should an entity perform a market capitalization reconciliation if not all assets and liabilities are assigned to a reporting unit?
- 8.3.270 Should an entity perform a market capitalization reconciliation if not all reporting units are subject to a quantitative impairment test?

Examples

- 8.3.10 Impairment comparison – equity vs enterprise value
- 8.3.20 Reporting unit with negative carrying amount
- 8.3.30 Measuring a reporting unit’s fair value – assumed tax structure
- 8.3.35 Guideline public companies method
- 8.3.36 Comparable transactions method
- 8.3.40 Discounted cash flow model
- 8.3.50 Measuring a reporting unit’s fair value – change in conditions

8.4 Asset groups

Questions

- 8.4.10 What valuation techniques are typically used to measure the fair value of an asset group?
- 8.4.20 Can an asset fail the recoverability test but not be impaired?
- 8.4.30 How do operating leases in the asset group affect the measurement of fair value?
- 8.4.40 Does an entity write down a held-and-used asset to fair value if the asset is not abandoned and the related asset group is not impaired?
- 8.4.50 Does an entity write off a damaged asset if the carrying amount of the asset group is otherwise recoverable?
- 8.4.60 If a long-lived asset is financed with nonrecourse debt, does the balance of outstanding debt limit the amount of any impairment loss?

Example

- 8.4.10 Carrying amount of a long-lived asset is greater than its fair value

8.5 Indefinite-lived intangible assets

Questions

- 8.5.10 How is the fair value of an indefinite-lived asset measured?
- 8.5.20 What techniques are typically used to measure the fair value of an indefinite-lived intangible asset?

8.1 How the standards work

The following diagram is an adaptation of the impairment diagram in [chapter 1](#), highlighting that fair value is the basis for measuring an impairment loss under all three models. Fair value is measured in accordance with Topic 820 (fair value measurement).

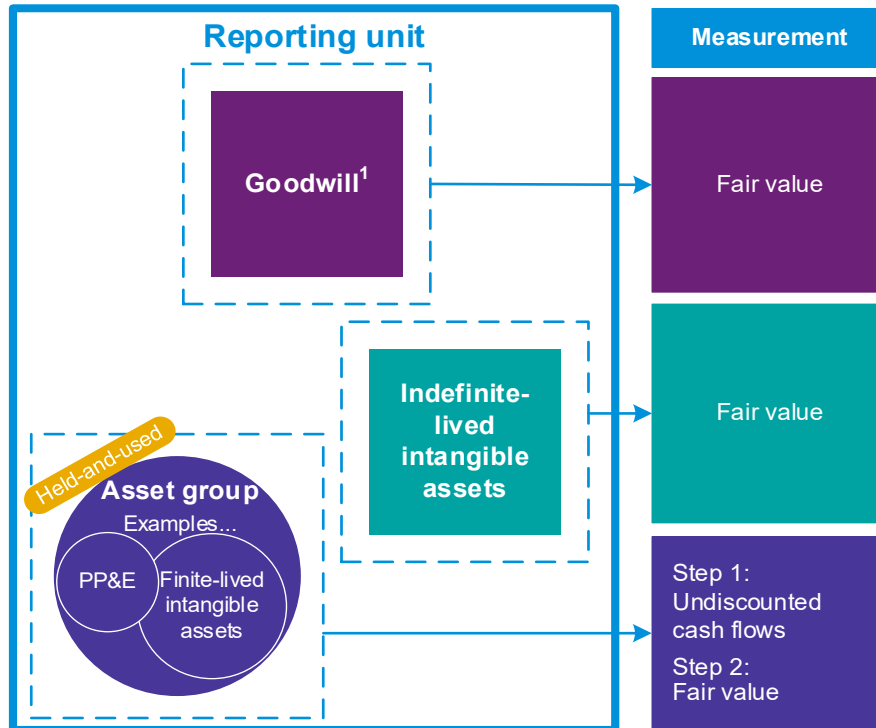

Note 1: Assumes (1) the entity has not elected the goodwill amortization accounting alternative (see chapter 11); and (2) ASU 2017-04 has been adopted (see Appendix A).

Measurement of an impairment loss related to goodwill or an indefinite-lived intangible asset is a single-step quantitative test. That test is required when:

- the entity performed a qualitative assessment and concluded it was more likely than not that the asset was impaired – i.e. the entity could not avoid the annual quantitative test;
- the entity did not perform a qualitative assessment, and instead proceeded directly to the annual quantitative test; or
- outside of the annual testing, the entity concluded that it was more likely than not that the asset was impaired.

Measurement of an impairment loss is Step 2 of the test for long-lived assets. That test is required when:

- based on one or more indicators of impairment, the entity concluded that the carrying amount of an asset group might not be recoverable; and
- the Step 1 recoverability test failed.

This chapter refers to the following throughout:

- an indefinite-lived intangible asset, although the unit of account might be a grouping of such assets (see [section 3.2](#)); and
- an asset group, although the unit of account might be a single asset (see [section 3.3](#)).

8.2 Principles of fair value measurement

8.2.10 Overview

This section provides a brief introduction to some of the key terms used in fair value measurement. These concepts and related interpretive questions are discussed in more detail in KPMG Handbook, [Fair value measurement](#).

Fair value is the price that would be received to sell an asset or paid to transfer a liability in an orderly transaction between market participants at the measurement date. Fair value is an exit price – e.g. the price to sell an asset instead of the price to buy that asset. An exit price embodies expectations about the future cash inflows and cash outflows associated with an asset or liability from the perspective of a market participant – i.e. based on buyers and sellers who have certain characteristics, such as being independent and knowledgeable about the asset or liability.

Fair value is a market-based measurement, not an entity-specific measurement, and is measured using assumptions that market participants would use in pricing the asset or liability, including assumptions about risk. As a result, an entity's intention to hold an asset is not relevant in measuring fair value.

Fair value is measured assuming a transaction in the principal market for the asset or liability – i.e. the market with the highest volume and level of activity. In the absence of a principal market, it is assumed that the transaction would occur in the most advantageous market. This is the market that would maximize the amount that would be received to sell an asset or minimize the amount that would be paid to transfer a liability, taking into account transaction and transportation costs. In either case, the entity needs to have access to that market, although it does not necessarily have to be able to transact in that market on the measurement date.

A fair value measurement is made up of one or more inputs, which are the assumptions that market participants would make in valuing the asset or liability. The most reliable evidence of fair value is a quoted price in an active market. When this is not available, an entity uses a valuation approach to measure fair value, maximizing the use of relevant observable inputs and minimizing the use of unobservable inputs.

These inputs also form the basis of the fair value hierarchy, which is used to categorize a fair value measurement (in its entirety) into one of three levels. This categorization is relevant for disclosure purposes. The disclosures about fair value measurements are extensive, with more disclosures being required for measurements in Level 3 of the hierarchy.

This chapter covers fair value measurement in impairment testing, starting with reporting units because of the broad application of the fair value concepts in valuing a business. Subsequent sections then consider how the measurement of an asset group might differ, and the typical approaches to valuing indefinite-lived intangible assets.

The following table identifies the process of measuring fair value, focusing on issues that are most relevant to the nonfinancial assets in the scope of this Handbook.

Establish parameters (section 8.2.20)	Identify the item being measured
	Identify the unit of account and the unit of valuation
	Identify market participants, and identify the market
Select appropriate valuation approach(es) and technique(s) (section 8.2.30)	Market approach Example technique: Quoted prices in an active market
	Income approach Example technique: Discounted cash flows
	Cost approach Example technique: Depreciated replacement cost
Determine inputs to measure fair value (section 8.2.40)	Level 1 Example: Quoted price for an identical asset in an active market
	Level 2 Example: Quoted price for a similar asset in an active market
	Level 3 Example: Cash flow forecasts and discount rates
Measure fair value (section 8.2.50)	Highest and best use
Disclose information about fair value measurement (see chapter 10)	

8.2.20 Establish parameters

In the context of impairment, the item being measured is the unit of account:

- a reporting unit;
- an asset group; or
- an indefinite-lived intangible asset (or a grouping thereof).

The unit of account is the level at which an asset is aggregated or disaggregated for recognition and measurement purposes. It is also the level at which an asset generally is aggregated or disaggregated for the purpose of measuring fair value. When these two units differ, the term unit of valuation is used to describe the unit used for fair value measurement. In the context of this Handbook, the unit of account and unit of valuation are the same as the item being measured.

An entity takes into account characteristics of the item (asset) being measured that market participants would take into account in a transaction for the asset at the measurement date. These characteristics may include, for example:

- the condition and location of the asset; and
- restrictions, if any, on the sale or use of the asset.

➤ *Read more:* Chapter C of KPMG Handbook, [Fair value measurement](#).

Market participants are buyers and sellers in the principal (or most advantageous) market for the asset that have all of the following characteristics:

- they are independent of each other;
- they are knowledgeable, having a reasonable understanding about the asset or liability and the transaction using all available information, including information that might be obtained through due diligence efforts that are usual and customary;
- they are able to enter into a transaction for the asset; and
- they are willing to enter into a transaction for the asset— i.e. they are motivated but not forced or otherwise compelled to do so.

➤ *Read more:* Chapter D of KPMG Handbook, [Fair value measurement](#).

The principal market is the market with the greatest volume and level of activity for the asset. The most advantageous market is the market that maximizes the amount that would be received to sell the asset, after taking into account transaction costs and transportation costs.

A fair value measurement assumes that the transaction takes place in the principal market for the asset. Only in the absence of a principal market does the entity assume that the transaction takes place in the most advantageous market.

➤ *Read more:* Chapter E of KPMG Handbook, [Fair value measurement](#).

8.2.30 Select appropriate valuation approach(es) and technique(s)

In measuring the fair value of an asset, an entity selects those valuation approaches and techniques that are appropriate and for which sufficient data is available to measure fair value. The technique chosen should maximize the use of relevant observable inputs and minimize the use of unobservable inputs (see [section 8.2.40](#)).

A valuation approach is a broad category of techniques, while a valuation technique refers to a specific technique such as a particular option pricing model.

Valuation approaches used to measure fair value fall under three categories.

- **Market approach.** Valuation techniques that fall under the market approach include quoted prices in an active market, but often derive market multiples from a set of comparable assets.
- **Income approach.** Valuation techniques that fall under the income approach convert future amounts such as cash flows or income streams to a current amount on the measurement date.
- **Cost approach.** Valuation techniques under the cost approach reflect the amount that would be required to replace the service capacity of an asset. The concept behind the cost approach is that an investor will pay no more

for an asset than the cost to buy or construct a substitute asset of comparable utility.

The following are examples of different valuation techniques used to measure assets in the scope of this Handbook under the three valuation approaches, and examples of common usage of those techniques.

Technique	Examples of common usage
Market approach	
Quoted price in an exchange market	Equity securities
Market multiples derived from a set of comparable assets – e.g. a price to earnings ratio expresses an entity’s per-share value in terms of its EPS	Unlisted equity interests
Income approach	
Present value techniques	Unlisted equity instruments
Multi-period excess earnings method: based on a discounted cash flow analysis that measures the fair value of an asset by taking into account not only operating costs but also charges for contributory assets; this isolates the value related to the asset to be measured and excludes any value related to contributory assets	Intangible assets, such as customer relationships and technology assets
Relief-from-royalty method	Intangible assets expected to be actively used (e.g. brands, acquired technology)
Cost approach	
Depreciated replacement cost method: considers how much it would cost to replace an asset of equivalent utility taking into account physical, functional and economic obsolescence; it estimates the replacement cost of the required capacity instead of the actual asset	Property, plant and equipment

➤ *Read more:* Chapter F of KPMG Handbook, [Fair value measurement](#).

8.2.40 Determine inputs to measure fair value

Inputs to valuation techniques are the assumptions that market participants would use in pricing the asset or liability. Inputs are categorized into three levels:

- **Level 1 inputs.** Unadjusted quoted prices in active markets for identical assets that the entity can access at the measurement date.
- **Level 2 inputs.** Inputs other than quoted prices included within Level 1 that are observable for the asset, either directly (i.e. as prices) or indirectly (i.e. derived from prices).

- **Level 3 inputs.** Unobservable inputs for the asset.

These inputs include assumptions about risk, such as the risk inherent in a particular valuation technique used to measure fair value and the risk inherent in the inputs to the valuation technique.

An entity selects the valuation techniques:

- that are appropriate in the circumstances;
- for which sufficient data is available; and
- that maximize the use of relevant observable inputs and minimize the use of unobservable inputs.

➤ *Read more:* Chapter F of KPMG Handbook, [Fair value measurement](#).

8.2.50 Highest and best use

There are a number of other considerations in the process of measuring fair value, but the one most relevant to the fair value of nonfinancial assets is 'highest and best use'. This is a valuation concept that represents the use of a nonfinancial asset by market participants that would maximize the value of the asset or the group of assets and liabilities (e.g. a business) within which the asset would be used.

The highest and best use of a nonfinancial asset establishes the valuation premise that is used to measure the asset's fair value (see [section 8.3.20](#)).

A fair value measurement of a nonfinancial asset considers a market participant's ability to generate economic benefits by using the asset at its highest and best use or by selling it to another market participant who would use the asset in its highest and best use

➤ *Read more:* Chapter J of KPMG Handbook, [Fair value measurement](#).

8.3 Reporting units

The discussion in this section does not repeat the principles discussed in KPMG Handbook, [Fair value measurement](#). Instead it focuses on a high-level understanding of specific practice issues that we have encountered in measuring the fair value of reporting units for impairment testing purposes. As such, this section is not intended to provide a detailed understanding of the issues, which are often complex depending on the entity's specific facts and circumstances. An entity will usually need to involve its valuation professional to assist in measuring fair value.

In addition, an entity may find the following publications to be useful:

- AICPA Accounting & Valuation Guides:
 - [Testing Goodwill for Impairment](#)
 - [Valuation of Privately-Held-Company Equity Securities Issued as Compensation](#)
 - [Valuation of Venture Capital and Private Equity Investments](#)

- The Appraisal Foundation:
 - [Valuations in Financial Reporting Valuation Advisory 3: The Measurement and Application of Market Participant Acquisition Premiums.](#)

8.3.10 Overview



Excerpt from ASC 350-20

- > Qualitative Assessment

35-4 The quantitative goodwill impairment test, used to identify both the existence of impairment and the amount of impairment loss, compares the fair value of a reporting unit with its carrying amount, including goodwill.

35-5 The guidance in paragraphs 350-20-35-22 through 35-24 shall be considered in determining the fair value of a reporting unit.

35-6 If the fair value of a reporting unit exceeds its carrying amount, goodwill of the reporting unit is considered not impaired.

- > Determining the Fair Value of a Reporting Unit

35-22 The fair value of a reporting unit refers to the price that would be received to sell the unit as a whole in an orderly transaction between market participants at the measurement date. Quoted market prices in active markets are the best evidence of fair value and shall be used as the basis for the measurement, if available. However, the market price of an individual equity security (and thus the market capitalization of a reporting unit with publicly traded equity securities) may not be representative of the fair value of the reporting unit as a whole.

35-23 Substantial value may arise from the ability to take advantage of synergies and other benefits that flow from control over another entity. Consequently, measuring the fair value of a collection of assets and liabilities that operate together in a controlled entity is different from measuring the fair value of that entity's individual equity securities. An acquiring entity often is willing to pay more for equity securities that give it a controlling interest than an investor would pay for a number of equity securities representing less than a controlling interest. That control premium may cause the fair value of a reporting unit to exceed its market capitalization. The quoted market price of an individual equity security, therefore, need not be the sole measurement basis of the fair value of a reporting unit.

35-24 In estimating the fair value of a reporting unit, a valuation technique based on multiples of earnings or revenue or a similar performance measure may be used if that technique is consistent with the objective of measuring fair value. Use of multiples of earnings or revenue in determining the fair value of a reporting unit may be appropriate, for example, when the fair value of an entity that has comparable operations and economic characteristics is observable and the relevant multiples of the comparable entity are known. Conversely, use of multiples would not be appropriate in situations in which the operations or

activities of an entity for which the multiples are known are not of a comparable nature, scope, or size as the reporting unit for which fair value is being estimated.

The quantitative goodwill impairment test compares a reporting unit's fair value to its carrying amount (including goodwill – see [section 5.4](#)). If the fair value of the reporting unit exceeds its carrying amount, goodwill is not impaired. [350-20-35-4, 35-6]

The quantitative test for goodwill is required when:

- the entity performed a qualitative assessment and concluded it was more likely than not that goodwill was impaired – i.e. the entity could not avoid the annual quantitative test;
- the entity did not perform a qualitative assessment, and instead proceeded directly to the annual quantitative test; or
- outside of the annual testing, the entity concluded it was more likely than not that goodwill was impaired.



Question 8.3.10

Can an entity combine reporting units in measuring fair value?

Interpretive response: No. Goodwill is subject to impairment testing at the reporting unit level; therefore, the fair value of each reporting unit should be separately determined. This is because the fair value of a reporting unit refers to the price that would be received to sell the unit as a whole in an orderly transaction between market participants at the measurement date. The unit as a whole in this case refers to an individual reporting unit. [350-20-35-22]

There may be cases in which a reporting unit has synergies with other reporting units of the entity, and a market participant would not be able to benefit from them – e.g. greater purchasing power from a vendor. It would not generally be appropriate to capture these synergies when measuring the fair value of an individual reporting unit. Measuring the fair value of combined reporting units, and then allocating that fair value to the individual reporting units, may inadvertently capture these synergies.

8.3.20 Valuation premise: enterprise vs equity value

Topic 350 does not prescribe a specific valuation premise when measuring the fair value of a reporting unit in testing goodwill for impairment. However, Topic 350 does require: [ASU 2017-04.BC26]

- the same assets and liabilities to be used to determine both the carrying amount and the fair value; and
- the methodology to be consistently applied.

This is consistent with a 2009 SEC speech that acknowledged the lack of authoritative guidance for a valuation premise, and specifically whether an enterprise or equity value premise should be used. The SEC staff stated that, in many circumstances, it did not anticipate the premise selected would impact the result. [\[2009 AICPA Conf\]](#)



Question 8.3.20

What is the difference between an enterprise value and an equity value?

Interpretive response: Two common valuation premises used to measure the fair value of a reporting unit are enterprise value and equity value.

- **Enterprise value** refers to the fair value of a reporting unit based on the value of cash flows available to debt and equity holders collectively – i.e. without regard to how the reporting unit is financed.
- **Equity value** refers to the fair value of a reporting unit’s outstanding equity instruments – i.e. the value available to equity holders after debt and other obligations have been fulfilled.

The following diagrams show the relationship between enterprise value and equity value.

Enterprise value



Notes:

1. Operating liabilities are all liabilities tied to the operations of the business (as opposed to its financing). Typically this includes working capital liabilities, but more broadly refers to all liabilities that are captured in the operating cash flows of the reporting unit.
2. Nonoperating assets are assets that are not required for the operations of the business. Examples include vacant land that is not needed for the future expansion of the business, rental properties unrelated to the primary business purpose or an art collection.

In practice, the term ‘enterprise value’ is often used as a generic term to mean both ‘operating enterprise value’ as well as ‘business enterprise value’. In the context of an impairment test, because nonoperating assets are not usually assigned to a reporting unit, there is typically no difference between the two values. However, if nonoperating assets are included in the carrying amount of the reporting unit (as shown in the above diagram), they generally have to be valued separately because their value contribution is not captured in the operating cash flows of the reporting unit. Further, they often have a risk profile different from the rest of the reporting unit, requiring a different discount rate (if valued under the income approach).

Equity value



Notes:

1. Interest-bearing liabilities (debt) are all liabilities that have an interest component. The most common examples are short- and long-term debt as well as pension liabilities.
2. Non-equity claims are all other liabilities that are non-interest bearing and that are not considered operating liabilities and are not captured in the operating cash flows – e.g. AROs or environmental liabilities.



Question 8.3.30#

What adjustments are made to enterprise value to derive equity value?

Interpretive response: As described in [Question 8.3.20](#), a reporting unit's enterprise value is based on cash flows available to debt and equity holders collectively – i.e. without regard to how the reporting unit is financed. Therefore, the effect of debt financing needs to be removed in determining the equity value.

To determine equity value under the income approach, the following fair value deductions are made from the enterprise value:

- interest-bearing liabilities (debt); and
- non-equity claims. This includes liabilities that are non-interest bearing and that are not considered operating liabilities. This means that changes in the carrying amount of these liabilities (including their eventual repayment) are not considered in the cash flows of the reporting unit – e.g. an ARO.

If an entity uses a market approach and measures the fair value of a reporting unit based on multiples that include cash flows available to both interest-bearing debt holders and equity holders (e.g. EBIT, EBITDA, revenue multiples), the resulting value is on an enterprise premise. Therefore, to derive an equity value, an entity would need to make adjustments similar to those described above.

When deriving an equity value, the interest-bearing liabilities and non-equity claims are measured at fair value. In many cases, the carrying amount of debt and non-equity claims can be used as a proxy for their respective fair values – especially if fair value assumes a sale of the entire reporting unit; this is because there are typically change-of-control provisions making such amounts callable at par (or a slight premium).

A more nuanced analysis is required if the reporting unit is a legal entity (or includes a legal entity) that has issued the debt and no change of control clause exists. In our view, this scenario is the only known scenario where the value of debt used may be different from par value and results in a difference between an enterprise and equity premise. In this case the starting point can be the observable (traded) fair value of the debt. However, the following are potential

considerations to the observable fair value that should be taken into account when determining the value of the debt for purposes of the impairment test:

- potential differences in the credit profile between the reporting unit and a market participant acquirer;
- the actual economic benefit to the market participant acquirer stemming from the debt that has coupon interest payments below current market rates;
- any potential premium that would be paid for control of the entire debt amount compared to trades in individual debt units; and
- the volume and activity comprising the traded price of the debt.



Question 8.3.40

Does the valuation premise (enterprise vs equity value) affect the impairment conclusion?

Interpretive response: Generally, no. As long as consistent assumptions are used, the valuation conclusion of an impairment test on an enterprise premise or equity premise will be the same. As discussed in [Question 8.3.30](#), an enterprise value can be adjusted to arrive at an equity value and vice versa. Care should be taken to match the cash flow assumptions to the treatment of related assets and liabilities in deriving the respective enterprise or equity value (see [Question 8.3.50](#)).

One exception that might cause a different result is if the reporting unit is a legal entity. If a reporting unit is a stand-alone legal entity and has debt that originated without any guarantees or recourse to a parent entity, the fair value of equity of the reporting unit would not be lower than zero; this is because there are no obligations that a market participant would take on.

Therefore, under an equity premise, the maximum impairment would be the difference between the reporting unit's carrying amount (including the debt) and zero. That is compared to an enterprise premise that excludes the debt from both the carrying amount and fair value. In the basis for conclusions to ASU 2017-04, the Board acknowledges this outcome. In this scenario, the entity may need to measure fair value under an enterprise premise. [\[ASU 2017-04.BC40\]](#)



Question 8.3.50 How does the valuation premise affect the carrying amount of the reporting unit for impairment purposes?

Interpretive response:

Enterprise value

When an entity performs the impairment test on an enterprise premise, the carrying amount corresponds to the total assets of the reporting unit less the operating liabilities. Debt and non-equity claims that are not identified as operating liabilities do not reduce the carrying amount.

The following diagram illustrates the amounts being compared.



Equity value

When an entity performs the impairment test on an equity premise, the carrying amount corresponds to the total equity of the reporting unit – i.e. all liabilities have been allocated to the reporting unit.

The following diagram illustrates the amounts being compared.

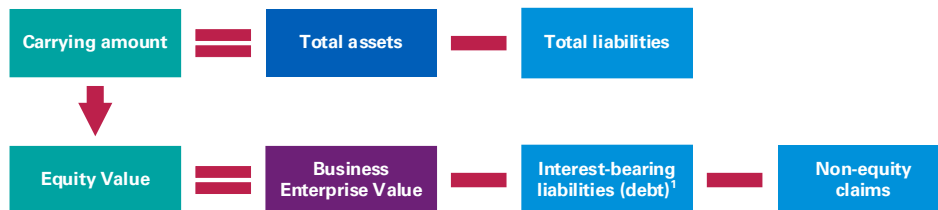

Example 8.3.10 Impairment comparison – equity vs enterprise value

ABC Corp. has one reporting unit and regularly conducts its impairment test on an equity premise. The reporting unit does not contain any nonoperating assets or non-equity claims to consider in its fair value estimate.

The following table illustrates that the results of ABC's quantitative test for goodwill is the same using either an enterprise or equity valuation premise.

Premise:	Equity	Enterprise
Operating assets	\$12,000	\$12,000
Less: Operating liabilities	(2,000)	(2,000)
Less: Interest-bearing debt	(6,000)	—
Carrying amount	\$ 4,000	\$10,000
Business enterprise value ¹	\$15,000	\$15,000
Less: interest-bearing debt	(6,000)	—
Equity value ²	9,000	—
Headroom (no impairment)	\$ 5,000	\$ 5,000

Notes:

1. The business enterprise value represents the reporting unit's cash flows generated from its operating assets and liabilities discounted using WACC. The reporting unit in this example does not have any nonoperating assets.
2. The equity value represents the reporting unit's business enterprise value less the fair value of debt. The reporting unit in this example does not have any non-equity claims.



Example 8.3.20

Reporting unit with negative carrying amount

ABC Corp. has several reporting units and performs its annual goodwill impairment test using an equity premise.

ABC is a single legal entity that holds debt and allocates it to the reporting units for impairment testing. In this example, it is assumed that the fair value of the debt approximates its book value (see [Question 8.3.30](#)).

RU-X has net assets with a carrying amount of negative \$200, made up of the following.

Recognized assets:	
Tangible assets	\$ 450
Intangible assets	250
Goodwill	500
Total recognized assets	\$1,200
Recognized liabilities:	
Operating liabilities	\$ 900
Debt (allocated)	500
Total recognized liabilities	1,400
Carrying amount of net assets	\$ (200)

ABC estimates the fair value of RU-X using a combination of a market approach (based on guideline public company multiples) and an income approach (based on a discounted cash flow model). Using these approaches, ABC first estimates the business enterprise value of RU-X as \$225.

Because ABC performs its impairment test on an equity premise, it deducts the fair value of the debt allocated to RU-X (\$500) from the business enterprise value to calculate a fair value of equity of negative \$275. Because the fair value is less than the carrying amount of negative \$200, ABC concludes that RU-X is impaired and records a goodwill impairment loss of \$75.

Because RU-X is not a separate legal entity and the allocated financial liabilities are the responsibility of ABC as the sole legal entity, the fair value of RU-X's equity could fall below zero – i.e. it is reasonable to assume that the fair value could be negative (see [Question 8.3.40](#)).

Note: If ABC performed the impairment test on an enterprise premise, RU-X's business enterprise value of \$225 would be compared to a carrying amount before the allocated debt of \$300 (\$1,200 - \$900 operating liabilities). This approach would have resulted in the same impairment loss of \$75.

8.3.30 Tax structure



Excerpt from ASC 350-20

- > Deferred Income Tax Considerations

35-25 Before estimating the fair value of a reporting unit, an entity shall determine whether that estimation should be based on an assumption that the reporting unit could be bought or sold in a nontaxable transaction or a taxable transaction. Making that determination is a matter of judgment that depends on the relevant facts and circumstances and must be evaluated carefully on a case-by-case basis (see Example 1 [paragraphs 350-20-55-10 through 55-23]).

35-26 In making that determination, an entity shall consider all of the following:

- a. Whether the assumption is consistent with those that marketplace participants would incorporate into their estimates of fair value
- b. The feasibility of the assumed structure
- c. Whether the assumed structure results in the highest and best use and would provide maximum value to the seller for the reporting unit, including consideration of related tax implications.

35-27 In determining the feasibility of a nontaxable transaction, an entity shall consider, among other factors, both of the following:

- a. Whether the reporting unit could be sold in a nontaxable transaction
- b. Whether there are any income tax laws and regulations or other corporate governance requirements that could limit an entity's ability to treat a sale of the unit as a nontaxable transaction.

Before estimating the fair value of a reporting unit, an entity should determine whether the estimate should be based on an assumption that the reporting unit would be sold in a nontaxable or taxable transaction. This determination will influence the type of cash flows included in the valuation under the income approach (see [Question 8.3.140](#)). This assumption is a matter of judgment that depends on the relevant facts and circumstances. [\[350-20-35-25\]](#)



Question 8.3.60

What is the difference between a taxable and a nontaxable transaction?

Interpretive response: The Codification does not define what constitutes a taxable or nontaxable transaction. We believe the terms mean the following.

- **Taxable transaction** describes a transaction in which the tax bases of the assets acquired and liabilities assumed of the acquired entity are adjusted to their acquisition-date fair value.
- **Nontaxable transaction** describes transactions in which the acquiree’s tax bases of the individual assets acquired and liabilities assumed are carried over by the acquiring entity.

For example, an exchange of the acquirer’s shares or cash consideration for the acquiree’s shares generally results in a nontaxable transaction, while an acquisition of the assets and liabilities of an acquiree for cash results in a taxable transaction.

In certain circumstances, a tax election may be available under Section 338 of the Internal Revenue Code, whereby the acquirer can elect to have an acquisition of shares treated as a taxable transaction. Involvement of tax professionals may be necessary to determine if an assumed tax structure will result in a taxable or nontaxable transaction.



Question 8.3.70

What tax structure does an entity assume in measuring the fair value of a reporting unit?

Interpretive response: In measuring the fair value of a reporting unit, the entity assumes the tax structure (taxable versus nontaxable) that: [\[350-20-35-26\]](#)

- is feasible;
- will result in the highest economic value (including consideration of related tax implications); and
- has assumptions consistent with those that market participants would incorporate into their estimates of fair value.

In determining the feasibility of a nontaxable transaction, an entity considers whether: [350-20-35-27]

- the reporting unit could be sold in a nontaxable transaction; and
- there are any income tax laws and regulations or other corporate governance requirements that could limit an entity’s ability to treat a sale of the unit as a nontaxable transaction.

 **Question 8.3.80**
What are key differences between an assumed taxable vs nontaxable structure?

Interpretive response: The assumed tax structure of a transaction can significantly affect the valuation of a reporting unit because it can affect the price a buyer is willing to pay for the reporting unit and the seller’s tax cost on the transaction.

Key differences that may arise between an assumed taxable and nontaxable structure of a transaction include the following (not exhaustive).

Taxable transaction	Nontaxable transaction
<p>Include an acquirer’s tax benefits for a step-up in basis, including the tax deduction (often referred to as a tax amortization benefit) available to an acquirer from the ability to write off intangible assets and goodwill.</p> <p>Exclude NOL carryforwards because these benefits generally are not realizable by the acquirer.</p>	<p>Include the amount of NOL carryforwards and built-in losses to the extent section 382 of the IRC would allow the acquirer to use them.</p> <p>Section 382 of the Internal Revenue Code imposes limits on the amount of NOLs and built-in losses that can be applied annually against income in the event of certain ownership changes.</p>

 **Example 8.3.30**
Measuring a reporting unit’s fair value – assumed tax structure

ABC Corp. believes it can sell Reporting Unit to market participants by receiving cash in exchange for:

- the shares in Reporting Unit (nontaxable transaction) for \$700; or
- the assets and liabilities of Reporting Unit (taxable transaction) for \$800.

Because either type of transaction is feasible, ABC needs to assume the method that results in the highest economic value to ABC. The tax basis of Reporting Unit’s net assets is \$350, which is the same as the tax basis of Reporting Unit’s shares (as a legal entity); the tax rate is 21%.

- If the shares in Reporting Unit were sold, ABC would have a current tax payable of \$74 because of the tax effect of the difference between the proceeds and the tax basis of the shares: $(\$700 - \$350) \times 21\%$.

- If the assets and liabilities of Reporting Unit were sold, ABC would have a current tax payable of \$95 on the sale: $(\$800 - \$350) \times 21\%$.

As shown in the table, this means that ABC should assume that Reporting Unit would be sold in a taxable transaction because the net economic value of the transaction is higher. Therefore, fair value for the purposes of impairment testing is \$800.

	Nontaxable transaction	Taxable transaction
Gross proceeds (fair value)	\$700	\$800
Less: taxes arising from transaction	(74)	(95)
Economic value	\$626	\$705

8.3.40 Market approach

The market approach has two distinct valuation techniques: the guideline public companies method and the comparable transactions method. Both methods generate an indication of the subject reporting unit's fair value using market-based information.

A key difference between the two methods relates to control. The results derived from the guideline public companies method represent the value of a noncontrolling interest as opposed to a controlling interest derived from the comparable transactions method. Therefore, a market participant acquisition premium (MPAP or control premium) is required for the guideline public companies method to estimate a controlling interest value.

If a reporting unit is publicly traded, its market price (assuming an active market) is used as the basis for measuring fair value (see [Questions 8.3.110](#) and [8.3.120](#)). [350-20-35-22]



Question 8.3.90

If market multiples are derived using the guideline public companies method, what are the key factors that influence the measurement?

Background: If fair value is based on multiples that include cash flows that are available to both interest-bearing debt holders and equity holders (e.g. revenue, EBITDA), the resulting value is generally on an enterprise premise (see [section 8.3.20](#)).

Interpretive response: The guideline public companies method looks to identify companies that are similar to the business (reporting unit) being valued. A typical starting point for potential comparable companies is direct competitors of the subject business (if public) as well as other public companies in the same industry.

In general, the following are the key value drivers of the market approach:

- the selection of comparable companies and/or transactions;
- the financial metrics being applied to the subject reporting unit (i.e. the market multiples); and
- adjustments made to the market multiples.

Selecting comparable companies

The initial search of comparable companies typically involves searching lists of public companies in the reporting unit's industry, including consideration of various factors such as industry similarity, financial risk, company size, profitability, relevance of available financial data and actively traded share prices.

If a large number of companies is identified, an entity selects a reasonable number of comparable companies by comparing the subject reporting unit to the pool of companies at a more refined level. A common method to refine the number of potential guideline companies is to limit the size of the potential comparable companies. Guideline companies should not be significantly larger or smaller than the subject reporting unit.

After selecting an initial group of guideline companies, the population is reviewed to determine the most comparable companies. Some companies may be omitted because they are less comparable or because pricing multiples or other financial information is unavailable. The remaining companies may vary in terms of relevance to the subject reporting unit and the most comparable companies will receive greater consideration than others when multiples are selected.

Market multiples

Market multiples are typically expressed as ratios of enterprise value of the comparable company to the underlying financial metric.

- The numerator is typically equity, business enterprise value or total invested capital.
- The denominator is typically net income (earnings), total assets, revenue, EBITDA or EBIT.

The numerator must be consistent with the corresponding metric in the denominator. For example, an analysis might use a market capitalization to earnings (P/E) ratio, or instead use a TIC (fair value of invested equity and debt) to EBITDA ratio. If the numerator uses equity, the financial metric in the denominator is post-interest expense, because economic benefit to equity holders is net of payments to debt holders.

The financial data used to calculate market multiples is either on a historical or projected basis. Historical data is typically on a trailing twelve-month or latest fiscal year basis. Similarly, projected data may cover the next twelve months, next fiscal year or multiple fiscal years. For cyclical industries, a multiple based on multiple periods may be considered. When several market multiples are determined to be relevant, judgment is required to identify the appropriate weighting for each multiple.

Adjustments to the market multiples and multiple selection

Adjustments to market multiples may be necessary to arrive at a set of multiples that are appropriately comparable to the subject reporting unit.

Example adjustments typically cover differences in profitability, expected growth, size, working capital needs, significant or unusual transactions, and nonrecurring income or expense.

Once the market multiples are identified for the set of comparable companies, the selection of the multiple to apply to the subject reporting unit is made. The selection of the market multiple requires careful consideration and analysis of the comparable companies and the subject reporting unit, including factors such as the nature of each business, the markets in which they operate, their size, profitability and other key performance indicators.

The underlying metrics (e.g. revenue, EBITDA) are affected by the underlying GAAP applied (e.g. US GAAP, IFRS® Accounting Standards) and an entity's accounting policy elections. This might influence the selection of comparable entities or require adjustments in deriving a multiple. For example, the different treatment of operating leases in the income statement under US GAAP versus IFRS Accounting Standards may require adjustments to most earnings-based multiples to ensure a like-for-like comparison between the guideline comparable companies and the subject reporting unit.

An entity should ensure that the selected multiples are appropriate for the subject reporting unit being valued, which will also depend on the quality of data and the industry. For example, an entity might consider a total invested capital/bed multiple when valuing a hospital.

In addition to industry-specific factors, entities often select a cash flow or earnings multiple. In these instances, consideration should be given to the capital structures of the subject reporting unit and the comparable companies. For example, if they have similar capital structures, post-interest expense multiples may be useful.

Lastly, it is important that the metrics used represent 'run rate' expectations. This means the comparable metrics should be adjusted for one-off or out-of-period events to the extent that information is available. The following are examples.

- A business has received a substantial one-time order from a customer that is not expected to be recurring. The impact of that order is removed from the baseline metric to determine the expected run rate performance that is representative of the business going forward.
- A business has a temporary loss of manufacturing capacity because of unforeseen nonrecurring events. This is adjusted for in baseline metrics as there would not be an expectation for these events to recur in subsequent years.

Similarly, the valuation metrics of the subject business should also represent run rate expectations and might have to be adjusted accordingly.

Weighting the multiples selected

Once the multiples to apply to the subject reporting unit are selected, the entity weights the multiples. The weighting requires careful consideration and analysis of comparable companies and the subject reporting unit. The following are example considerations in practice.

- An entity’s decision to lease versus own property, plant and equipment affects the amount of rent expense compared to depreciation and amortization expense recognized. This is considered in the comparison to the guideline companies and how their EBIT and EBITDA metrics are impacted by their respective decisions. The weightings of the multiples are adjusted accordingly to put a higher weight on the multiple with greater comparability.
- In our experience, greater weight is placed on revenue multiples when the subject reporting unit is not profitable. Conversely for profitable entities, generally less weight is placed on revenue multiples because market participants generally favor earnings-based multiples (i.e. EBITDA and EBIT).

Applying an MPAP

The results derived from the guideline public companies method represents the value of a noncontrolling interest. Therefore, an MPAP is added to estimate a controlling interest value (see [Questions 8.3.110](#) and [8.3.120](#)).



Example 8.3.35

Guideline public companies method

ABC Corp. is using the guideline public companies (GPC) method to estimate the fair value of one of its reporting units.

Selecting comparable companies

ABC is a privately held restaurant chain with 25 stores across several states in the Northeast United States. ABC identifies four comparable publicly traded entities.

Market multiples

ABC considers different valuation multiples that may be used to determine the reporting unit’s fair value.

ABC determines that the most relevant valuation multiples are TIC (fair value of invested equity and debt) to revenue, EBITDA and EBIT ratios. For each of the guideline companies, ABC:

- determines the market capitalization of the comparable company (publicly traded);
- adds the fair value of the comparable company’s interest-bearing debt; and
- divides the sum of the comparable company’s equity and debt (together, TIC) by its most recent 12-month revenue, EBITDA and EBIT measures.

ABC calculates the following valuation multiples based on the market data for each guideline company at the valuation date.

Guideline company	Revenue growth	Earnings growth	EBITDA margin	TIC / Revenue	TIC / EBITDA	TIC / EBIT
Comp 1	10%	10%	17%	1.2x	5.5x	7.0x
Comp 2	15%	11%	21%	1.6x	6.5x	9.0x
Comp 3	9%	5%	19%	0.9x	4.0x	6.0x
Comp 4	4%	5%	31%	1.1x	4.5x	6.5x
ABC	15%	10%	22%			
			Average	1.2x	5.1x	7.1x
			Median	1.2x	5.0x	6.8x

Adjustments to the market multiples and multiple selection

ABC does not make any adjustments to the market multiples because there were no substantial differences in profitability, expected growth, size, working capital needs, significant or unusual transactions, and nonrecurring income or expense in the guideline companies.

Using the data of comparable companies related to revenue growth, earnings growth, and EBITDA margin, and taking into account the nature of each business, ABC concludes that Comp 1 and Comp 2 are better matches than the other two companies, but that neither one is better than the other.

Other factors ABC might consider in selecting multiples include size, forecasted growth rates, geographic regions served, and typical customer profiles of the comparable entities. Any significant differences between market data and the subject reporting unit should be analyzed.

ABC assigns equal weighting to the multiples of Comp 1 and Comp 2, as shown in the table below, and selects those multiples to be used in the next step of the valuation process.

Guideline company	TIC / Revenue	TIC / EBITDA	TIC / EBIT
Comp 1	1.2x	5.5x	7.0x
Comp 2	1.6x	6.5x	9.0x
Selected multiples	1.4x	6.0x	8.0x

ABC's selected valuation multiples are applied to the appropriate financial data of the subject reporting unit as of the valuation date. Based on the comparable TIC to revenue, EBIT and EBITDA ratios, three different indications of TIC fair value are calculated for ABC.

Weighting the multiples selected

- ABC operates using lower property, plant, and equipment ownership levels than the comparable companies. Therefore, ABC places the greatest

weight on the earnings multiple before taking into account depreciation and amortization expenses (i.e. EBITDA), which is weighted at 50%.

- The EBIT value multiple is weighted at 35%, because it is an earnings-based multiple, while recognizing its limitation due to the effects of different property, plant, and equipment ownership levels on depreciation and amortization.
- Because there have been limited instances where deals have been priced based on revenue multiples and the subject reporting unit is profitable, the revenue value multiple was favored the least and weighted at 15%.

Applying an MPAP

Finally, to determine the subject reporting unit's equity fair value on a controlling interest basis, ABC selects an appropriate MPAP. See [Questions 8.3.110](#) and [8.3.120](#) for additional considerations in the selection of a control premium.

FY 20X0	Revenue	EBITDA	EBIT
ABC Corp.	\$54,000	11,880	9,720
Selected multiples	1.4x	6.0x	8.0x
Implied TIC value range	75,600	71,280	77,760
Less: debt	15,000	15,000	15,000
Implied equity value range	60,600	56,280	62,760
Weighting	15%	50%	35%
Equity value (marketable, noncontrolling interest basis)	59,196		
Plus: MPAP at 5% ¹	2,960		
Equity value rounded (controlling interest basis)	\$62,200		

¹ Selected MPAP is for illustration purposes only.



Question 8.3.100

Can an entity use forward-looking market multiples when markets are distressed?

Interpretive response: It depends. When applying the guideline public companies method (see [Question 8.3.90](#)), forward multiples, which are based on projected financial metrics, may sometimes be used to better incorporate future growth and profitability.

When there is significant uncertainty in distressed markets, public companies may withdraw their earnings guidance. Earnings estimates by equity analysts may also be withdrawn or could be stale. In those circumstances, observable forward multiples may no longer be current or may be otherwise unreliable.

Conversely, when an entity is exhibiting high growth and earnings estimates are available, forward-looking multiples may be appropriate.

Therefore, entities should be cautious about using observable forward multiples in distressed markets and should perform additional due diligence to assess their reasonableness. In particular, they should confirm the date of estimates and how the estimates have been updated. If reliable forward-looking analyst estimates can be obtained, entities must also be careful to ensure that the subject reporting unit's projected financial metrics are also current.



Question 8.3.110

If fair value is based on an entity's share price, how is an MPAP supported?

Background: An acquirer is often willing to pay more for a controlling interest in equity securities to take advantage of the related synergies and other benefits than an investor would pay for a number of equity securities that represent less than a controlling interest. That MPAP may cause the fair value of a reporting unit to exceed its market capitalization. [350-20-35-23]

If fair value is based on an entity's share price, the resulting value is on an equity premise (see [section 8.3.20](#)). This fair value measurement technique is often used when an entity has a single reporting unit.

The MPAP is expressed through either enhanced cash flows or lower required rates of return.

Interpretive response: There are three broad ways in which an MPAP may be supported.

- An acquirer may believe it can change the stand-alone cash flows of the business through better management. In our experience, it is uncommon to assert that a new owner would be able to better manage the stand-alone operations of the business.
- An acquirer may believe that as a controlling shareholder it would have a lower risk, and therefore a lower required rate of return, than a minority shareholder in a public company. In our experience, this is likely to be less important in markets with strong corporate governance and minority shareholder protections.
- An acquirer may expect to create synergies through combining the acquired business with existing operations to increase the aggregate cash flows of the combining units. In our experience, this is typically the most significant factor contributing to the existence of an MPAP.

Generally, the amount of an MPAP is best corroborated by specific, comparable and current transactions in the subject reporting unit's industry. The factors giving rise to such premiums in industry transactions are considered, and their potential existence in a hypothetical acquisition is assessed.

In making this assessment, the entity must be careful to exclude any buyer-specific synergies reflected in observed industry control premiums. For example, MPAPs in industry transactions may reflect specific synergies that

were expected to be available to the combining entities. Such synergies may arise from the nature of the entities' operations, including the degree of overlap therein, anticipated tax benefits from the transaction, etc. These benefits might not be available to a market participant acquirer of the subject reporting unit, and therefore would not be included in measuring fair value.

An MPAP based on arbitrary 'rule of thumb' percentages, or on an amount selected to avoid an impairment loss, for example, is not appropriate. Further, changes in MPAPs from prior periods should be supported by objective evidence.

The SEC staff has noted that the amount of the control premium "can require a great deal of judgment" and "a registrant needs to carefully analyze the facts and circumstances of their particular situation when determining an appropriate control premium and ... there is normally a range of reasonable judgments a registrant might reach." Further, the SEC staff noted it expects that the amount of evidence supporting management's judgment would increase as the control premium increases. [\[2008 SEC Conf\]](#)

An entity should document its assessment of the MPAP, including its key judgments. The level of documentation should increase as the level of MPAP increases.



Question 8.3.120

How does an entity evaluate an increase in MPAP in distressed markets?

Interpretive response: As noted in [Question 8.3.110](#), generally the MPAP is best corroborated by specific, comparable and current industry transactions. However, if there is no (or limited) current market activity, historical transactions may need to be considered.

In a distressed market, volatility is generally higher and market capitalizations tend to be lower; as a result, MPAPs generally increase as compared to historical premiums. Therefore, determining a reasonable MPAP in such circumstances will require additional judgment and consideration of the entity's specific facts and circumstances and available comparable transactions; and more time will likely be spent supporting this assumption. Following the SEC staff's observations, we would expect the amount of evidence supporting management's judgment to increase. [\[2008 SEC Conf\]](#)

However, notwithstanding the additional challenges of determining a reasonable MPAP in distressed markets, entities cannot apply arbitrary 'rule of thumb' percentages or back into an amount that avoids an impairment loss.



Question 8.3.125

If market multiples are derived using the comparable transactions method, what are the key factors that influence the measurement?

Background: The comparable transactions method is similar in theory to the guideline public companies (GPC) method. However, instead of using prices of publicly traded company stock, it considers valuation multiples derived from change-in-control transactions.

Interpretive response: Using the comparable transactions method, transactions involving comparable target entities are identified.

Generally, an entity would identify transactions where the target entity was acquired outright. If less than 100% was acquired, control attribute differences may exist between the guideline company and the interest in the subject reporting unit and would need to be considered.

Selecting comparable transactions

Selecting the most comparable acquired entities requires judgment based on both qualitative and quantitative factors. Factors to consider in selecting the most appropriate transactions include industry, size, forecasted growth rates, geographic regions serviced and typical customer profiles. Entities should understand the reasons for significant differences observed between market data and the subject reporting unit.

One limitation of this method is finding transactions of companies similar to the subject reporting unit close to the valuation date. Another limitation is insufficiently detailed disclosure of facts surrounding the transactions. For example, the financial data of the acquired entity may be limited, unavailable or unreliable, thereby making it difficult to derive multiples. Another example is that information may not be available regarding whether contingent consideration was included in a comparable transaction.

An important consideration in selecting comparable transactions is whether the acquisitions represent orderly arm's-length transactions. For example, transactions between related parties should only be considered in certain circumstances where a determination can be made that the transaction was an orderly arm's length transaction.

Further, if transactions occurred at a date well in advance of the valuation date, they may be less relevant due to the passage of time. Transactions should also be assessed to determine whether entity-specific synergies were included in the consideration paid.

Selecting the multiples to apply

The process of selecting multiples is identical to that used in the GPC method discussed in Question 8.3.90. As a reasonableness check, if both the GPC and comparable transactions methods are used, multiples selected in the latter method would normally be higher than the results derived from the GPC method.

Results in the GPC method represent the value of a noncontrolling interest that requires the application of an MPAP in the final step as opposed to a controlling interest derived from the comparable transactions method. As a result, the value in the comparable transactions method does not require the application of an MPAP and may have a higher value because the multiples are already based on a controlling interest.



Example 8.3.36

Comparable transactions method

ABC Corp. is using the comparable transactions method to estimate the fair value of one of its reporting units.

Selecting comparable transactions

The primary quantitative factors ABC considers when selecting the final list of acquired comparable transactions are transactions in the same industry, geographic regions and customer profiles that represent orderly arm's-length transactions within a few months of the valuation date.

Selecting the multiples to apply

Using the data of the acquired companies related to revenue growth, earnings growth and EBITDA margins, and considering the business descriptions of the acquisition targets, ABC chooses three transactions and selects pricing multiples it believes to be representative of the subject reporting unit's performance in comparison to those of the chosen acquisition targets.

ABC concludes that Transactions 1 through 3 represent comparable acquisitions that occurred within the past year. Similar to [Example 8.3.35](#), ABC relies on the TIC (fair value of invested equity and debt) to revenue, EBITDA and EBIT ratios, and weights are placed on the EBITDA multiple at 50%, the EBIT multiple at 35%, and then the revenue multiple at 15%.

Selected comparable transactions	TIC / Revenue	TIC / EBITDA	TIC / EBIT
Transaction 1	1.4x	6.1x	8.3x
Transaction 2	1.6x	6.7x	8.5x
Transaction 3	1.5x	5.7x	8.8x
Average	1.5x	6.2x	8.5x
Median	1.5x	6.1x	8.5x
Selected multiples ¹	1.5x	6.1x	8.5x
ABC's financial information	\$54,000	11,880	9.720
Implied TIC value range	81,000	72,468	82,620
Less: debt	15,000	15,000	15,000
Implied equity value range	66,000	57,468	67,620
Weighting	15%	50%	35%
Equity value (rounded)	\$62,300		

¹Although the median of the observed range was deemed the best indicator of fair value from the perspective of market participants in this example, the median may not be the appropriate multiple in many situations.

8.3.50 Income approach

The income approach converts future cash flows to a current amount on the measurement date. The fair value measurement reflects current market expectations about those future amounts, discounted to their present value. The concept behind the income approach is that the reporting unit is worth what it is expected to earn, discounted for the time value of money and associated risks. A valuation technique that falls under the income approach is the discounted cash flow method, which is commonly used in the quantitative impairment test for goodwill. The direct capitalization method is another valuation technique under the income approach and is suitable when cash flows are at or will soon reach a stable state (see [Question 8.3.215](#)).



Question 8.3.130

If fair value is based on discounted cash flows, what are the key factors that influence the measurement?

Interpretive response: The discounted cash flow approach is based on the discounted cash flows derived from future earnings. This requires an entity to make various estimates and judgments that have a significant impact on the fair value estimate.

The key drivers of fair value in a discounted cash flow model include:

- the expected future cash flows (see [Question 8.3.140](#));
- the forecast period of discrete cash flows (see [Question 8.3.150](#));
- the discount rate (see [Questions 8.3.160 to 8.3.180](#)); and
- if applicable, the derivation of the residual value (see [Question 8.3.190](#)).

Each of these assumptions requires management judgment and should be determined from a market participant perspective. In addition, [Question 8.3.200](#) discusses the effect of distressed economic conditions.



Question 8.3.140

How are management's cash flow projections adjusted to reflect market participant assumptions?

Interpretive response: The expected future cash flows used in the quantitative test for goodwill generally start with a recent business plan or internally developed budget for the reporting unit being valued.

Ensuring that the expected future cash flows are consistent with a market participant view generally involves comparing management’s internal forecasts to industry analysts’ forecasts for the industry/reporting unit, competitor information, third-party economic forecasts and any other relevant macroeconomic data. After analyzing the external evidence, an entity may have to adjust future cash flows that are not indicative of those that a market participant may achieve.

Because the starting point for expected future cash flows is generally management’s internal budget or forecast, there are other adjustments that may be necessary to:

- arrive at a market participant view of the reporting unit; and
- comply with the valuation premise of the income approach – that the fair value of a reporting unit is predicated on the value of the future cash flows it is expected to generate.

Common adjustments to management’s budget or forecast include the following.

Cash flows from future acquisitions	Cash flows from future acquisitions are generally not included in the fair value of a reporting unit because market participants generally would not include such cash flow assumptions in valuing the reporting unit.
Cash flows from future restructurings	The costs and benefits of any future uncommitted action that is expected to improve cash flows are generally not included in the expected future cash flows of the reporting unit.
Working capital	The discounted cash flow method premise is based on normal working capital levels. If a reporting unit has excess or deficient net working capital amounts at the measurement date, an adjustment is necessary to arrive at fair value.
Depreciation and amortization	These are noncash items that are typically removed from the expected future cash flows and are replaced by capital expenditures. However, the tax effects of depreciation and amortization that will result in future cash tax savings are included.
Related party transactions	Adjustments may be necessary for intercompany transactions that are conducted on terms inconsistent with those of a market participant.
Tax rate	Typically, the appropriate tax rate is a statutory rate. Adjustments may be necessary to ensure the tax rate is representative of what a market participant would assume for the business.

In addition, cash flows are removed from the expected future cash flows if they are associated with entity-specific synergies that a market participant acquirer would not have. Market participant synergies should be interpreted broadly in this regard and are based on the overall level of synergies instead of on the specific type of synergies.

For example, if the entity has a particular revenue synergy included in its cash flows and a market participant would have a comparable but different revenue synergy, the overall level of the synergies available to either party would be

considered market participant synergies even though the specific source of the respective synergy might be distinct and unique.



Question 8.3.150

What forecast period is used for estimated future cash flows?

Interpretive response: The discrete projection period is specific to the reporting unit being valued and should represent the time required for the cash flows of the reporting unit to reach a steady state. This period is important because it is a significant component of the fair value of the reporting unit and the cash flows at the end of the discrete period serve as the basis for the residual value calculation (see [Question 8.3.190](#)).



Question 8.3.160

How is the discount rate determined in applying the discounted cash flow method?

Interpretive response: In measuring fair value under the discounted cash flow method, expected future cash flows are discounted using a discount rate that reflects a current market assessment of the time value of money and the risks specific to the reporting unit. The discount rate is based on the return investors would require if they were to choose an investment that would generate cash flows of amounts, timing and risk profile equivalent to those of the reporting unit. In other words, the discount rate is based on a market participant's view of the reporting unit as of the measurement date.

It is rare that a discount rate can be observed directly from the market. Therefore, an entity will generally need to build up a market participant discount rate that appropriately reflects the risks associated with the cash flows of the reporting unit being valued.

The most common approach is to estimate the appropriate rate using the entity's weighted-average cost of capital (WACC). Because a reporting unit-specific WACC is required, adjustments to an entity-specific WACC may be necessary. However, the overall WACC in such a case may provide a useful reference point when determining the component of the appropriate WACC for a reporting unit. Adjustments to the entity's WACC should be made with the objective of developing a market participant discount rate.

The WACC is a post-tax discount rate and incorporates the market's view of how an entity would structure its financing using both debt and equity, with each having a different rate of return. The formula for the WACC is as follows.

$$WACC = \left(\frac{E}{K} \times r_e \right) + \left(\frac{D}{K} \times b(1 - t) \right)$$

E = fair value of equity as a component of total capital

D = fair value of debt as a component of total capital

K = debt + equity

r_e = cost of equity

b = cost of debt: the rate at which the entity could obtain financing for its operations, before any effects of interest reducing taxable income

t = corporate tax rate: used to reduce the debt rate to a post-tax rate, because debt typically results in a reduction in taxable income

The relative weights of debt and equity in a WACC calculation are based on the fair value, not the carrying amount, of debt and equity of the entity. Further, the weights are generally based on a market participant's estimated capital structure; therefore, the entity's actual debt/equity ratio is not determinative in the calculation.

In determining the cost of equity as an input to the reporting unit's WACC, it is common to use the capital asset pricing model (CAPM). This model estimates the cost of equity by adding risk premiums to the risk-free rate. The formula for the CAPM is as follows.

$$r_e = r_f + \beta \times (r_m - r_f) + \alpha$$

r_e = cost of equity

r_f = risk-free rate

β = beta, which is a measure of the correlation between a share's return in relation to the market return (or the return of a fully diversified portfolio of investments)

$(r_m - r_f)$ = market return less the risk-free rate or the equity risk premium. This risk premium reflects systematic or market risk – i.e. the overall risk premium of a fully diversified portfolio of investments above the risk-free rate

α = alpha, or unsystematic (entity-specific) risk premium. The most common alpha factors used are size premium and company-specific risk premium

The leverage – i.e. the proportion of reporting unit financing that is funded by debt – and the cost of debt used in the WACC for determining fair value are not entity-specific. The discount rate is independent of the entity's current capital structure and the way in which the entity financed past acquisitions.

Therefore, the leverage and cost of debt are those that the market participant would expect in relation to the reporting unit being tested for impairment. In other words, the actual funding of the reporting unit, which will often include intragroup debt, is not relevant in determining leverage for the purposes of the market participant's WACC. Instead, the WACC for the fair value calculation is

based on the cost and amount of debt of a market participant investing in the cash flows of the reporting unit.

The cost of debt is based on long-term rates being incurred at the date of valuation for new borrowings, instead of the rates negotiated historically in the debt market for existing borrowings. Determining appropriate rates includes considering the entity's incremental borrowing rate.

A key assumption underpinning the WACC is a constant level of leverage throughout the cash flow period, including in the residual value (see [Question 8.3.190](#)).

In considering leverage and the cost of debt, the following are possible sources of information, none of which is likely to be determinative in isolation:

- the cost of debt incurred by the entity at present, taking into account any need to refinance, as a proxy for the cost of debt of a market participant;
- the current market borrowings of comparable entities, considering both levels of debt and interest rates;
- the entity's current or implied credit rating;
- the current credit ratings of comparable companies;
- recent industry acquisitions and refinancing; and
- information available from the entity's bank or other financial advisors.

The following table provides a high-level summary of key components of the cost of equity calculation.

Risk-free rate	A rate generally obtained from the valuation date spot yield on government bonds that are in the same currency and have the same or a similar duration as the cash flows of the reporting unit, often leading to 10- or 20-year government bonds being considered.
Beta factor	A factor reflecting the risk of a particular sector or industry relative to the market as a whole; it is a long-term (typically two or five years) instead of a short-term measure. Beta is typically calculated for individual listed companies using a regression analysis against an appropriate share index. When developing the cost of equity from a market participant's perspective, the selected beta is generally based on comparable entities' betas even if the subject entity is a listed entity.
Equity risk premium	A measure of the long-term required rate of return on equities above the risk-free rate; therefore, it should not be impacted significantly by short-term volatility.
Size premium	An additional premium that takes into account that smaller businesses are more risky than larger organizations. Size premiums are generally based on long-term information that is not impacted significantly by short-term volatility.
Company-specific risk premium	An additional premium sometimes included that takes into account any additional risk associated with the subject reporting unit. Forecast risk embedded in the financial projections often accounts for a large percentage of this premium.
Other alpha factors	Additional premiums that take into account risks not otherwise reflected in the CAPM. For example, country risk is an additional premium that takes into account the additional risk associated with generating and incurring cash flows in a particular country. In some

	cases, country risk is incorporated into the equity risk premium, and care is required to avoid double counting.
--	--



Question 8.3.170

What present value techniques are commonly used to discount forecasted cash flows?

Interpretive response: There are two common present value techniques with regard to the discount rate. [820-10-55-10 – 55-20]

- **Discount rate adjustment technique.** This method uses one set of forecasted cash flows and includes a premium in the discount rate for all possible risks – including risks in the timing of the cash flows, liquidity risks, credit risks, market risks, etc. It is generally linked with the use of notable alpha factors (see components of the cost of equity in [Question 8.3.160](#)).
- **Expected present value technique.** The expected cash flows are discounted at a rate that corresponds to an expected rate of return associated with the expected cash flows. The expected cash flows should reflect the general expectations of market participants for the reporting unit.

The discount rate should consider all of the risks associated with the cash flows being discounted to the extent that these risks have not been considered in the cash flows. See also [Question 8.3.180](#).

The discount rate and the future cash flows always have to be assessed concurrently, because the discount rate used in the analysis must reflect the assumptions and risk profile inherent in the future cash flows. The outcome under both techniques should be the same as long as assumptions with regard to risk are made consistently.

The cash flows and the discount rate applied to them should be determined on a consistent basis. For example, if the cash flows include the effect of general inflation (i.e. they are expressed in nominal terms) then the discount rate also includes the effects of inflation. Conversely, if the cash flows exclude the effects of inflation, the discount rate also excludes the effects of inflation.



Question 8.3.180

Can cash flows be discounted using a risk-free rate?

Interpretive response: Generally, no. In theory, an entity could use expected cash flows – representing a probability-weighted average of all possible cash flow scenarios – to derive certainty-equivalent cash flows. Because all risk elements are captured in the cash flows, the appropriate discount rate would then be risk-free rate (US Treasury rate in the United States) to discount cash flows to estimate fair value. This is Method 1 discussed in Topic 820 and illustrated in [Example 2 \(Case B\)](#) in Topic 360. [820-10-55-15]

Such an approach generally requires a simulation-type analysis (e.g. Monte Carlo simulation) that explicitly takes into account all possible outcomes and all risk factors. However, it can be difficult (if not impossible) to identify all possible cash flow scenarios for a business. Therefore, this approach is rarely used in practice. Instead, entities apply Method 2 in Topic 820 whereby certain (but not all) risks are captured in the cash flows, and the discount rate is an expected rate of return associated with the probability-weighted cash flows. [820-10-55-16]



Excerpt from ASC 360-10

> Illustrations

- > Example 2: Probability-Weighted Cash Flows
- • > Case B: Expected Cash Flows Technique

55-30 This Case illustrates the application of an expected present value technique to estimate the fair value of a long-lived asset in an impairment situation.

55-31 The following table shows by year the computation of the expected cash flows used in the measurement. They reflect the possible cash flows (probability-weighted) used to test the manufacturing facility for recoverability in Case A, adjusted for relevant marketplace assumptions, which increases the possible cash flows in total by approximately 15 percent.

Year	Possible Cash Flows (Market) (in \$ millions)	Probability Assessment	Expected Cash Flows (Undiscounted) (in \$ millions)
1	\$ 4.6	20%	\$ 0.9
	6.3	50	3.2
	7.5	30	2.3
			\$ 6.4
2	\$ 4.6	20%	\$ 0.9
	6.3	50	3.2
	7.5	30	2.3
			\$ 6.4
3	\$ 4.3	20%	\$ 0.9
	5.8	50	2.9
	6.7	30	2.0
			\$ 5.8
4	\$ 4.3	20%	\$ 0.9
	5.8	50	2.9
	6.7	30	2.0
			\$ 5.8
5	\$ 4.0	20%	\$ 0.8
	5.4	50	2.7
	6.4	30	1.9
			\$ 5.4
6	\$ 4.0	20%	\$ 0.8
	5.4	50	2.7
	6.4	30	1.9
			\$ 5.4
7	\$ 3.9	20%	\$ 0.8
	5.1	50	2.6
	5.6	30	1.7

				\$	5.1
8	\$	3.9	20%	\$	0.8
		5.1	50		2.6
		5.6	30		1.7
				\$	5.1
9	\$	3.9	20%	\$	0.8
		5.0	50		2.5
		5.5	30		1.7
				\$	5.0
10	\$	4.9	20%	\$	1.0
		6.0	50		3.0
		6.5	30		2.0
				\$	6.0

55-32 The following table shows the computation of the expected present value; that is, the sum of the present values of the expected cash flows by year, each discounted at a risk-free interest rate determined from the yield curve for U.S. Treasury instruments. In this Case, a market risk premium is included in the expected cash flows; that is, the cash flows are certainty equivalent cash flows. As shown, the expected present value is \$42.3 million, which is less than the carrying amount of \$48 million. In accordance with paragraph 360-10-35-17 the entity would recognize an impairment loss of \$5.7 million.

Year	Expected Cash Flows (Undiscounted) (in \$ millions)	Risk-Free Rate of interest	Expected Present Value (in \$ millions)
1	\$ 6.4	5.0%	\$ 6.1
2	6.4	5.1	5.8
3	5.8	5.2	5.0
4	5.8	5.4	4.7
5	5.4	5.6	4.1
6	5.4	5.8	3.9
7	5.1	6.0	3.4
8	5.1	6.2	3.2
9	5.0	6.4	2.9
10	6.0	6.6	3.2
	<u>\$ 56.4</u>		<u>\$ 42.3</u>



Question 8.3.190

How is the present value of the residual cash flows determined in applying the discounted cash flow method?

Interpretive response: The present value of residual cash flows in a discounted cash flow method represents the value of all cash flows beyond the discrete projection period based on a rate at which an entity expects them to grow in perpetuity. This means that two rates are important in the calculation: the post-projection period growth rate and the discount rate used to present value the cash flows. Typically, the residual value in a discounted cash flow method represents a substantial portion of the fair value of a reporting unit.

In our experience, there are three widely used approaches to determine the residual value.

- **Constant growth model.** The constant growth model is often referred to as the Gordon growth model and it assumes that the subject business has reached a mature and steady state. The terminal value year is computed assuming a constant future growth rate, which is often derived based on long-term industry growth expectations or expected inflation. Care is required in selecting the long-term growth rate, especially if a growth rate in excess of the long-term expected rate of inflation is selected.
- **Fading growth model.** The fading growth model, or H-model, is often used when a high growth business has not reached a mature and steady state by the end of the discrete projection period. The H-model assumes an initial period of high growth, followed by a long-term growth rate similar to a constant growth model in perpetuity. Instead of using an H-model, it is also possible to extend the discrete projections period, so that the growth can be trended down toward the selected long-term growth rate.
- **Exit market multiple.** The selection of an exit multiple essentially results in a combination of an income approach for the discrete cash flow period and a market approach for the residual value period (see [section 8.3.40](#)).

It is usually important to benchmark (1) the implied exit multiple when using a growth model or (2) the implied long-term growth rate when using an exit multiple to assess the reasonableness of the selected metric.



Example 8.3.40 Discounted cash flow model

ABC Corp. is preparing a discounted cash flow model under the income approach to estimate the fair value of one of its reporting units.

The expected future cash flows used in the model are based on the three-year strategic plan that was approved by ABC's board of directors. ABC uses a five-year discrete projection period, which represents three years of cash flows from the strategic plan (adjusted for market participant assumptions) plus two years of cash flows (again based on market participant assumptions).

The fair value of the reporting unit is measured as the present value of the discrete period cash flows plus the present value of the residual cash flows. ABC applies a capitalization rate to the cash flows estimated in Year 5 to estimate the present value of the residual cash flows.

The following summarizes ABC's discounted cash flow model and the results of the impairment test.

Projection period:	Discrete cash flows					Residual
	Yr 1	Yr 2	Yr 3	Yr 4	Yr 5	Yr 6
Expected cash flows ¹	\$100	\$112	\$125	\$150	\$180	\$ 184
Residual value						1,415
Present value factor (15% WACC ²)	0.93	0.81	0.71	0.61	0.53	0.53
Discounted cash flows	\$ 93	\$ 91	\$ 89	\$ 92	\$ 95	\$ 750
Present value of discrete period cash flows						\$ 460
Plus: Present value of the residual cash flows ³						750
Business enterprise value						\$ 1,210
Less: Carrying amount of reporting unit						(1,000)
Headroom						\$ 210
Notes:						
1. The expected cash flows over the discrete projection period are derived from management's projections, economic and industry forecasts, and other market participant factors (see Questions 8.3.140 and 8.3.150).						
2. The expected cash flows over the discrete period are discounted to their present value using the WACC (see Questions 8.3.170 and 8.3.180).						
3. The residual period cash flows represent the value of the reporting unit after the discrete projection period. The residual period cash flows were derived using a constant growth model with 2% growth (see Question 8.3.190). The present value of the residual cashflows is calculated as the residual years expected cash flows divided by the WACC less long-term growth rate, discounted using the present value factor $((\$184 / (15\% - 2\%)) \times 0.53)$.						



Question 8.3.200

How does an entity adjust its discounted cash flow models to reflect distressed economic conditions?

Interpretive response: When economic conditions are distressed, we expect that entities will adjust both the expected future cash flows and the discount rate for the increased risk factors when compared to analyses in more stable market conditions.

For example, it may be necessary to incorporate an entity-specific risk premium in the cost of equity estimate. In addition to the discount rate and financial projections, the long-term growth rate is another assumption that may be impacted, and previous long-term growth rate assumptions may need to be revisited.



Question 8.3.210

If an entity expects conditions after the measurement date to change, does it reflect that expectation in measuring fair value?

Interpretive response: It depends. An entity does not determine fair value based on expected changes in conditions as if they had already occurred. However, if market participants would include in their valuation an assessment of the probability of a change in conditions, then this probability – using market participant assumptions – is reflected in arriving at fair value.



Example 8.3.50

Measuring a reporting unit's fair value – change in conditions

Scenario 1: Environmental regulations expected to be reversed

The Environmental Protection Agency introduced new regulations that increase the cost of operating a mine, reducing the profitability and fair value of mines owned by ABC Corp. Following extensive lobbying, ABC believes the rules will be reversed in the next two years.

In this scenario, ABC prepares its valuation of the reporting unit based on the regulations in place at the date of the valuation. However, to the extent market participants would consider the probability of the rules being reversed, ABC's valuation should reflect this as a possible scenario in measuring fair value.

Scenario 2: Tax law expected to be reversed

DEF Corp. has a reporting unit in a less developed country (LDC) that manufactures and sells the key ingredient of a consumer product. The legislature of the LDC enacted changes in the country's tax law that makes the reporting unit's product significantly more expensive than similar ingredients produced using an alternative commodity. DEF expects that the tax legislation will have an adverse effect on the operations of the reporting unit.

DEF expects that the adverse tax change will be reversed because (1) legal action is under way to reverse the tax and (2) the executive branch of the LDC's government favors abolishing the discriminatory tax. However, the legislature of the LDC shows no willingness to reverse the enacted tax law.

In this scenario, DEF prepares its valuation of the reporting unit based on the current legislation. However, the extent to which market participants believe the tax law will be reversed is reflected in the assumptions used to value the business. The reporting unit should not be valued as if the tax law had been reversed unless that is consistent with the assumptions of market participants.



Question 8.3.215

When is the direct capitalization method used?

Interpretive response: The direct capitalization method is another valuation method under the income approach. It is suitable when cash flows are at or will soon reach a stable state. This could be the case when there is steady growth, zero growth or steady contraction.

In some cases, entities may include the direct capitalization method within the discounted cash flow method. For example, once the cash flows achieve a steady state after a discrete term within the discounted cash flow method, the terminal value of the business may be calculated using the direct capitalization method. The application is comparable to the terminal value considerations discussed in [Question 8.3.190](#).

8.3.60 Selecting valuation techniques



Question 8.3.220

What constraints does an entity face when selecting valuation techniques?

Interpretive response: Neither Subtopic 350-20 nor Topic 820 dictate the valuation techniques to use. However, if a reporting unit has issued publicly traded equity securities, the quoted market prices of those equity securities generally are viewed as the best indicator of fair value. Nevertheless, because the fair value of a reporting unit may exceed its market capitalization, other valuation techniques may be applied in addition. [\[350-20-35-22 – 35-23\]](#)

When quoted market prices are not available, the appropriate valuation approaches or techniques depend on the underlying value drivers, the reliability of inputs to be used, and the way in which a market participant would view and price the reporting unit.

An entity should document contemporaneously why it chose the technique(s) used, the key assumptions involved, and how those assumptions are consistent with the following:

- other similar types of assumptions used by the entity – e.g. in strategic planning, budgeting, realization of deferred taxes and incentive compensation arrangements;
- available external data – e.g. economic conditions; and
- public disclosures and statements the entity has made.



Question 8.3.230

Can multiple valuation approaches or techniques be used to fair value the same unit of account?

Interpretive response: Yes. In many cases, multiple valuation approaches or techniques are appropriate. For example, when estimating the fair value of a reporting unit, both a market approach and an income approach might be used. If multiple valuation approaches are used, the results of each should be considered and weighted, as appropriate, in measuring the fair value of the reporting unit. [820-10-35-24, 35-24B]

When it is appropriate to use a combination of valuation approaches or techniques to measure fair value, we expect each of the valuation approaches or techniques to reasonably corroborate the results of the other. In theory, each measure of fair value should converge as the calculations in each are further refined. Judgment should be applied when placing greater emphasis on one valuation approach or technique over another.

Less reliance should be placed on internally developed models that have not been calibrated to either observable transactions or past acquisitions. If an entity previously determined the fair value of a reporting unit based 50% on a market approach and 50% on an income approach, it would not be appropriate to rely 100% on the income approach simply because the market capitalization has fallen significantly.

8.3.70 Reconciling fair value to market capitalization



Question 8.3.240

Should an entity reconcile the fair value of its reporting units to its market capitalization?

Interpretive response: Yes. SEC registrants should perform a reconciliation of the aggregate fair value of multiple reporting units to market capitalization at a goodwill impairment test date and monitor those differences at future reporting dates. The need for a reconciliation is especially relevant if the market value is lower than the fair value. [SEC Regs Comm 10/2008, 2008 AICPA Conf]

The reconciliation of the fair value of the reporting units to the entity's market capitalization serves as an overall check of the reasonableness of the estimated fair values attributed to multiple reporting units as part of a goodwill impairment test. The SEC staff has indicated that it will ask for this analysis in their filing reviews. Simply stating that there is an implied control premium if the market capitalization is below the aggregate fair value of the entity's reporting units is not an adequate reason. There is no bright-line test used to assess the reasonableness of an MPAP; instead, it is facts and circumstance driven and there would be an expected range of outcomes based on reasonable judgments. [2008 AICPA Conf]

When performing the reconciliation, an entity may consider the best practice guidance provided by the AICPA to identify and document significant differences between market capitalization and fair value, including control synergies, asymmetric data, entity-specific versus market capital structures, and other factors. Some or all of the difference between market capitalization and fair value may be ascribed to an MPAP, depending on the circumstances (see [Question 8.3.110](#)). However, an entity should not simply default to ascribing an increase in the difference between the market capitalization and the concluded fair value to an increase in the MPAP. Instead, the entity should understand how its share price has been affected by general market conditions and volatility (see [Question 8.3.120](#)).

A low share price may reflect a temporary decline. However, a low market capitalization, especially when below the entity's or the reporting unit's carrying amount, may indicate that there are additional factors to consider in determining the fair value of the reporting unit(s).



Question 8.3.250

Can an entity use an average share price when reconciling to market capitalization?

Interpretive response: Generally, yes. The SEC staff has stated that in volatile market conditions it may be appropriate, in many cases, for management to consider the market capitalization based on an average share price over a reasonable period as a better estimate of the fair value of a reporting unit (or an entity). [\[2008 AICPA Conf\]](#)

The length of the averaging period will depend on entity-specific facts and circumstances. For example, it may not be appropriate to consider prices in periods before certain events – e.g. loss of key customers, revision(s) in earnings guidance, and reductions in workforce – because the change in price may not be due solely to volatility in the capital markets.

In any case, it is expected that an entity would prepare robust documentation of its key judgments in determining the averaging period.



Question 8.3.255

If an average share price is used when reconciling to market capitalization, can an entity consider share prices after the measurement date?

Interpretive response: Generally, no. If an entity concludes that it is appropriate to use an average share price to reconcile to market capitalization (see [Question 8.3.250](#)), the SEC staff has stated that it would be reasonable to look at market capitalization over a reasonable period of time leading up to (i.e. not beyond) the impairment testing date. [\[2008 AICPA Conf\]](#)

Changes in share prices after the measurement date are usually not considered because they do not reflect conditions at the measurement date – i.e. they are

a nonrecognized subsequent event under Topic 855. However, such changes may require an entity to reevaluate whether all conditions existing at the measurement date were considered. [855-10 Glossary]



Question 8.3.260

Should an entity perform a market capitalization reconciliation if not all assets and liabilities are assigned to a reporting unit?

Background: Assets (other than goodwill) and liabilities are assigned to a reporting unit only if they meet certain criteria. Therefore, some assets and liabilities may remain unassigned (see [section 5.4.30](#)).

Interpretive response: Yes. An entity should consider any unallocated assets and liabilities as part of the reconciliation analysis and not simply ascribe the difference between the sum of the fair values of the reporting unit and the market capitalization to an MPAP.

Further, to the extent that an enterprise value premise is used in determining fair value (see [section 8.3.20](#)), the entity's market capitalization needs to be adjusted to reflect debt when reconciling to market capitalization as a reasonableness check (see [Question 8.3.30](#)).



Question 8.3.270

Should an entity perform a market capitalization reconciliation if not all reporting units are subject to a quantitative impairment test?

Interpretive response: Yes, although the approach may differ. When an entity has performed a quantitative measurement of fair value for only certain of its reporting units, it could be difficult to perform the market capitalization reconciliation. This may result in management having to use greater judgment about when and how to perform this evaluation. [ASU 2011-08.BC34]

An approach management could take in these circumstances is to perform a high-level reconciliation by considering both:

- the current-year fair value for reporting units for which quantitative measurements were performed in the current year; and
- the results of past quantitative measurements and current qualitative assessments for the remaining reporting units.

8.4 Asset groups



Excerpt from ASC 360-10

• > Fair Value

35-36 For long-lived assets (asset groups) that have uncertainties both in timing and amount, an expected present value technique will often be the appropriate technique with which to estimate fair value.

Step 2 of the impairment test for long-lived assets compares the asset group's fair value to its carrying amount (see [section 5.3](#)). If the fair value of the asset group exceeds its carrying amount, none of the long-lived assets in the asset group are impaired. Conversely, if the fair value of the asset group is less than its carrying amount, an impairment loss is recorded (see [Question 9.3.10](#) for allocation guidance).

This Step 2 test for long-lived assets is required when:

- based on one or more indicators of impairment, the entity concluded that the carrying amount of an asset group might not be recoverable; and
- the Step 1 recoverability test failed.



Question 8.4.10

What valuation techniques are typically used to measure the fair value of an asset group?

Interpretive response: Topic 360 notes that the expected present value technique will often be appropriate; however, it does not rule out other techniques. [[360-10-35-36](#)]

If the asset group is a business, the discussion in [section 8.3](#) related to reporting units applies, including the discussion of the income approach and discounted cash flows in [section 8.3.50](#). In referring to a 'business', this does not imply the definition of a business in Topic 805.

If the asset group is not a business, in addition to valuation techniques that fall under the market and income approaches, depreciated replacement cost is often used to value factory plant and equipment (see [section 8.2.30](#)).

Regardless of technique, the concept of 'highest and best use' is important. In determining highest and best use, the entity considers the factors in the following diagram, based on market participants using the asset group(s) on a stand-alone basis or in combination with other assets.

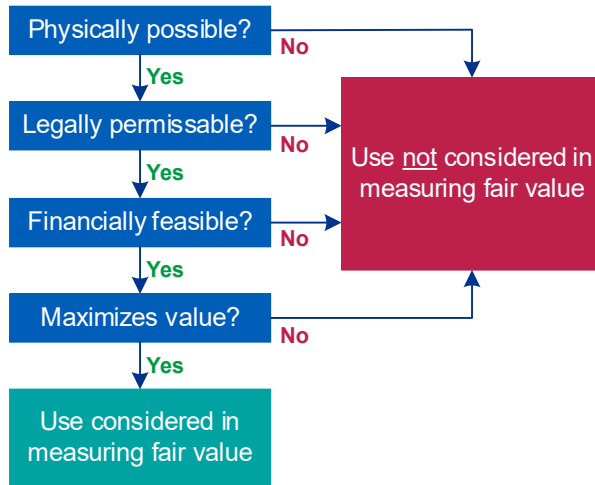

For example, a market participant might develop the entity’s factory into condominiums. Assuming that the above criteria are met, fair value is based on that alternative use.

Customer relationships and technology assets are often valued using the multi-period excess earnings method; and brands are often valued using the relief-from-royalty method (see [section 8.5](#)).

For an in-depth discussion of how to measure fair value, see KPMG Handbook, [Fair value measurement](#). Valuations are often complex and the entity will need to involve its valuation professional to assist.



Question 8.4.20

Can an asset fail the recoverability test but not be impaired?

Interpretive response: Yes. The cash flows used in the recoverability test are undiscounted and are based on the entity’s own assumptions about its use of the asset group (see [Question 7.2.10](#)). However, fair value is based on the assumptions that market participants would make, which may result in different assumptions about the use of the asset group (see [Question 8.4.10](#)).



Question 8.4.30

How do operating leases in the asset group affect the measurement of fair value?

Interpretive response: In measuring the fair value of an asset group that includes operating leases, it is important to ensure that consistent assumptions are made in measuring fair value and how the carrying amount of the asset group is determined. See [Question 5.3.40](#).

- **Market approach.** If the fair value of the asset group is based on a quoted market price, it should reflect the lessee’s decision about whether to include or exclude the operating lease liabilities from the carrying amount of the asset group. If it does not, an appropriate adjustment is required.
- **Discounted cash flow method.** If the lessee excludes the operating lease liabilities from the carrying amount of the asset group, it should also exclude the lease payments from the discounted cash flows used to measure the asset group’s fair value. In contrast, if the lessee includes the operating lease liabilities in the carrying amount of the asset group, it would also include the lease payments in the discounted cash flows.

These approaches are discussed in more depth in Questions 6.5.33 to 6.5.37 of KPMG Handbook, [Leases](#).



Question 8.4.40

Does an entity write down a held-and-used asset to fair value if the asset is not abandoned and the related asset group is not impaired?

Interpretive response: No. Topic 360 does not permit direct writedowns to fair value for individual assets classified as held-and-used if the asset group to which it belongs is not impaired. An entity reduces the carrying amount of a held-and-used asset to fair value only if the asset group:

- fails the Step 1 recoverability test; and
- the Step 2 fair value test identifies an impairment loss for the asset group.

Even if the asset is itself the asset group (see [section 3.3](#)) and therefore a loss would be identified in Step 2, an entity cannot proceed to Step 2 if it passes Step 1.



Example 8.4.10

Carrying amount of a long-lived asset is greater than its fair value

ABC Corp. has an office building held for rental whose fair value is substantially less than its carrying amount. The building is mortgaged and generating net losses, with more expected in the future.

However, the building passes the recoverability test because the following exceed its carrying amount:

- the undiscounted expected future cash flows from the operations of the office building (which excludes interest charges); plus
- the undiscounted residual value of the building.

As a result, ABC is not permitted to recognize an impairment loss for the excess of the building’s carrying amount over its fair value.



Question 8.4.50

Does an entity write off a damaged asset if the carrying amount of the asset group is otherwise recoverable?

Interpretive response: Assuming the damage to the asset is covered by insurance, the entity writes off the damaged asset and recognizes a gain or loss on involuntary conversion – the nonmonetary asset (the damaged asset) is being converted to a monetary asset (insurance proceeds). This accounting applies even if the insurance proceeds will be used to replace the asset, and even if the carrying amount of the related asset group is recoverable. [610-30-25-2]

Regardless of insurance coverage, if a component of a composite asset is destroyed – e.g. the roof on a building is destroyed in a hurricane – the entity writes off the carrying amount of that destroyed component. This writeoff is unrelated to impairment testing – the destroyed component has no further utility to the entity.



Question 8.4.60

If a long-lived asset is financed with nonrecourse debt, does the balance of outstanding debt limit the amount of any impairment loss?

Interpretive response: No. Topic 360 does not limit the amount of an impairment loss for an asset financed with nonrecourse debt. Recognizing an asset impairment and recognizing a gain on a subsequent debt extinguishment are separate events. Following general principles:

- the carrying amount of the asset group generally excludes the carrying amount of the debt (see [Question 5.3.30](#)); and
- correspondingly, the estimated future cash flows from the use and eventual disposition of the asset group exclude any cash flows related to the debt (see [Questions 7.4.20](#) and [7.5.60](#)).

As a result, an entity might recognize an impairment loss in one period when the asset group is determined to be not recoverable, and a gain on extinguishment of the nonrecourse debt in a later period when the liability is legally extinguished.

In a simple example, an entity borrows \$1,000 to purchase land; the loan is nonrecourse. Several years later, the land has a fair value of \$600, while the balance due to the lender is \$800. The impairment loss on the land is \$400: \$1,000 (carrying amount of land) - \$600 (fair value of land). If the entity later defaults on the loan and transfers the land to the lender in settlement, assuming no changes in values, the entity will record a gain of \$200: \$800 (carrying amount of loan) - \$600 (post-impairment carrying amount of land).

8.5 Indefinite-lived intangible assets



Excerpt from ASC 350-30

- > Intangible Assets Not Subject to Amortization

35-19 The quantitative impairment test for an indefinite-lived intangible asset shall consist of a comparison of the fair value of the asset with its carrying amount. If the carrying amount of an intangible asset exceeds its fair value, an entity shall recognize an impairment loss in an amount equal to that excess. After an impairment loss is recognized, the adjusted carrying amount of the intangible asset shall be its new accounting basis.

35-20 Subsequent reversal of a previously recognized impairment loss is prohibited.

A quantitative test for an indefinite-lived intangible asset – or the larger unit of account to the extent that two or more are combined – is required when:

- the entity performed a qualitative assessment and concluded it was more likely than not that the asset was impaired – i.e. the entity could not avoid the annual quantitative test (see [chapter 6](#));
- the entity did not perform a qualitative assessment, and instead proceeded directly to the annual quantitative test (see [Question 6.3.20](#));
- outside of the annual testing, the entity concluded it was more likely than not that an indefinite-lived intangible asset (or group of indefinite-lived intangible assets) was impaired (see [section 4.3](#)).



Question 8.5.10

How is the fair value of an indefinite-lived asset measured?

Interpretive response: The following summarizes the key concepts that an entity applies in measuring the fair value of indefinite-lived intangible assets.

<p>Identify the unit of account and the unit of valuation</p>	<p>The unit of account is generally a single asset unless a group of separately recorded indefinite-lived intangible assets are operated as a single asset – i.e. essentially inseparable from one another (see section 3.2).</p>
<p>Identify market participants</p>	<p>Market participants are buyers for the asset that have all of the following characteristics:</p> <ul style="list-style-type: none"> — they are independent of each other; — they are knowledgeable, having a reasonable understanding about the asset and the transaction using all available information;

	<ul style="list-style-type: none"> — they are able to enter into a transaction for the asset; and — they are willing to enter into a transaction for the asset – i.e. they are motivated but not forced or otherwise compelled to do so.
Select appropriate valuation approach(es) and technique(s)	An entity selects those valuation approaches and techniques that are appropriate and for which sufficient data is available to measure fair value. The technique chosen should maximize the use of relevant observable inputs and minimize the use of unobservable inputs (see section 8.2.30).
Determine inputs to measure fair value	Inputs to valuation techniques are the assumptions that market participants would use in pricing the asset or liability. These inputs include assumptions about risk, such as the risk inherent in a particular valuation technique used to measure fair value and the risk inherent in the inputs to the valuation technique (see section 8.2.40).
Measure fair value	The 'highest and best' use of the asset establishes the valuation premise that is used to measure its fair value. This is a valuation concept that represents the use of the asset by market participants that would maximize the value of the asset or the group of assets and liabilities (e.g. a business) within which the asset would be used.

 **Question 8.5.20**
What techniques are typically used to measure the fair value of an indefinite-lived intangible asset?

Interpretive response: In our experience, the fair value of indefinite-lived intangible assets other than IPR&D is usually measured using an income approach. Valuation techniques that fall under the income approach convert future amounts such as cash flows or income streams to a current amount on the measurement date.

For indefinite-lived intangible assets that are actively used in the business (e.g. brands), the specific valuation technique used most frequently is the relief-from-royalty method, which measures the fair value of an asset using a cost-savings concept. This is based on the notion that, if the entity did not own the asset, it would pay a royalty to a third party for the right to use that asset. Therefore, the value of the asset is the fair value of the cost savings of not paying a royalty to a third party.

The fair value of the asset is estimated based on the present value of the royalty payments that the acquirer saves by owning the asset, based on a market participant royalty rate. In many cases, the royalty rate is estimated based on market data for royalty arrangements involving similar assets. Because there may be limitations on the availability of observable data, the company (or its valuation professional) should develop appropriate support for the royalty rate used.

In our experience, the fair value of IPR&D is most frequently measured using the multi-period excess earnings method, which is an income approach.

9. Recognition and allocation

Detailed contents

9.1 How the standards work

9.2 Indefinite-lived intangible assets

Questions

- 9.2.10 How is an impairment loss allocated when two or more indefinite-lived intangible assets form a single unit of account?
- 9.2.20 Does an impairment loss related to an indefinite-lived intangible asset indicate that it may no longer have an indefinite life?

Example

- 9.2.10 Indefinite-lived intangible asset removed from unit of account

9.3 Long-lived assets

Questions

- 9.3.10 How is an impairment loss allocated within an asset group?
- 9.3.20 Does the sale of a held-and-used long-lived asset soon after the asset group is tested for impairment affect the allocation of an impairment loss?
- 9.3.30 In addition to writing down a long-lived asset for impairment, what other accounting implications are there?
- 9.3.40 Can an impairment loss on a long-lived asset be reversed in the future if circumstances change?

Examples

- 9.3.10 Impairment loss allocation within an asset group
- 9.3.20 New cost basis after impairment loss

9.4 Goodwill

- 9.4.10 Recognizing and allocating an impairment loss
- 9.4.20 Allocating an impairment loss to goodwill components for tax purposes
- 9.4.30 Allocating impairment losses between parent and NCI

Questions

- 9.4.10 How can the impairment test for long-lived assets in a reporting unit affect the amount of goodwill impairment loss?

- 9.4.20 What are the components of goodwill for income tax accounting purposes?
- 9.4.30 Does an impairment loss always have a related tax effect?
- 9.4.40 Is the recoverability of deferred tax assets assessed before or after applying the simultaneous equation?
- 9.4.50 How is the impairment loss allocated when the simultaneous equation results in the loss exceeding the goodwill balance?
- 9.4.60 How is an impairment loss allocated to the components of goodwill?
- 9.4.70 How is a goodwill impairment loss allocated to multiple tax jurisdictions within a reporting unit?
- 9.4.80 How is a goodwill impairment loss allocated between the parent and NCI?

Examples

- 9.4.10 Long-lived assets tested for impairment before goodwill
- 9.4.20 Long-lived assets tested for impairment before goodwill – asset group equals reporting unit
- 9.4.30 First and second component goodwill
- 9.4.40 Goodwill impairment – taxable transaction
- 9.4.50 Goodwill impairment – nontaxable transaction
- 9.4.60 Tax-deductible goodwill fully impaired
- 9.4.70 Goodwill impairment – complex scenarios
- 9.4.80 Allocating goodwill impairment to lower levels
- 9.4.90 Goodwill impairment allocated to parent and NCI

9.1 How the standards work

The following diagram is an adaptation of the impairment diagram in [chapter 1](#), showing the recognition and allocation model for impairment losses for each type of nonfinancial asset.

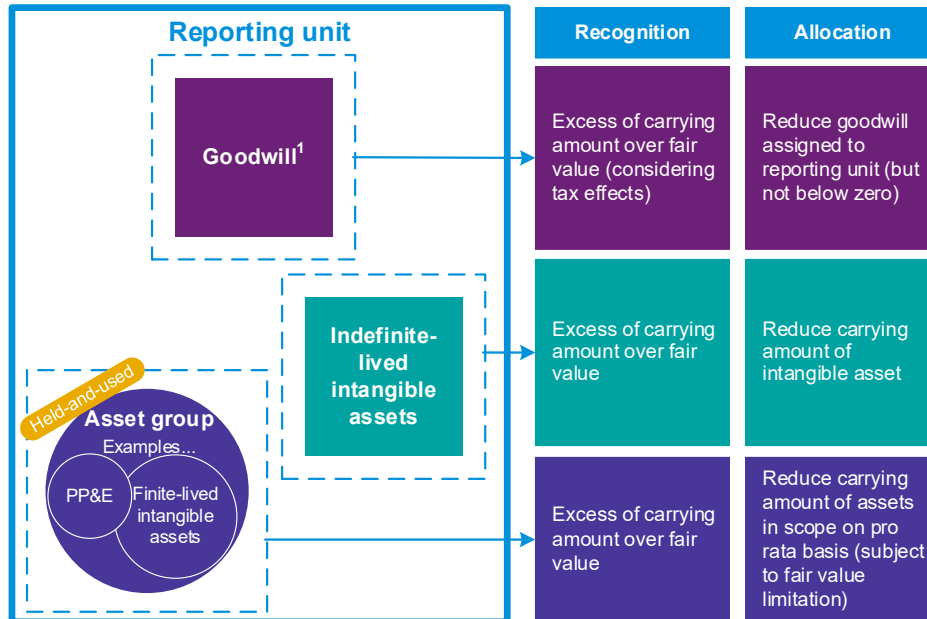

Note 1: Assumes (1) the entity has not elected the goodwill amortization accounting alternative (see chapter 11); and (2) ASU 2017-04 has been adopted (see Appendix A).

The allocation of a goodwill impairment loss can be complex because of the related accounting for deferred taxes. To facilitate the accounting, goodwill is separated into two components.

- The **first component** of goodwill equals the lesser of goodwill for financial statement purposes and tax-deductible goodwill.
- The **second component** of goodwill is the remainder of any goodwill for financial statement purposes or tax purposes.

When a goodwill impairment loss creates a related tax benefit, a simultaneous equation is used to resolve the circular problem of a tax benefit increasing the carrying amount of the reporting unit above its fair value.

This chapter refers to the following throughout:

- an indefinite-lived intangible asset, although the unit of account might be a grouping of such assets (see [section 3.2](#)); and
- an asset group, although the unit of account might be a single asset (see [section 3.3](#)).

9.2 Indefinite-lived intangible assets



Excerpt from ASC 350-30

- > Intangible Assets Not Subject to Amortization

35-19 The quantitative impairment test for an indefinite-lived intangible asset shall consist of a comparison of the fair value of the asset with its carrying amount. If the carrying amount of an intangible asset exceeds its fair value, an entity shall recognize an impairment loss in an amount equal to that excess. After an impairment loss is recognized, the adjusted carrying amount of the intangible asset shall be its new accounting basis.

35-20 Subsequent reversal of a previously recognized impairment loss is prohibited.

If an entity concludes that an indefinite-lived intangible asset is impaired, it is written down to its fair value (see [section 8.5](#)). The writedown creates a new cost basis for the asset, and reversal of the impairment loss is prohibited. [350-30-35-19 – 35-20]



Question 9.2.10

How is an impairment loss allocated when two or more indefinite-lived intangible assets form a single unit of account?

Interpretive response: There is no guidance in Subtopic 350-30 on how to allocate impairment losses to different indefinite-lived intangible assets when they form a single unit of account. Practically, however, if the assets meet the criteria to be combined as a single unit of account, an allocation issue only arises when an asset is removed from that single unit of account. In that case, an entity will need to split the carrying amount between the different assets.

We believe it is reasonable for an entity to allocate an impairment loss to the assets in the unit of account at the time the loss was incurred on a pro rata basis using the assets' historical carrying amounts.



Example 9.2.10
Indefinite-lived intangible asset removed from unit of account

In Year 1, ABC Corp. identifies a unit of account that comprises three indefinite-lived intangible assets: Assets A, B and C. The assets have the following historical carrying amounts.

- Asset A, \$ 100
- Asset B, \$ 200
- Asset C, \$ 300

In Year 2, the unit of account has a \$60 impairment loss.

In Year 3, ABC removes Asset B from the unit of account. To do so, ABC allocates the Year 2 impairment loss to the three assets pro rata on the basis of their historical carrying amounts, as follows.

	Carrying amount	Impairment loss allocation	New cost basis
Asset A	\$100	$\$60 \times (\$100 / \$600)$	\$ 90
Asset B	200	$\$60 \times (\$200 / \$600)$	180
Asset C	300	$\$60 \times (\$300 / \$600)$	270
Total	\$600		\$540

Therefore, ABC reduces the unit of account’s carrying amount by \$180. The remaining carrying amount of the unit of account is \$360 (Asset A \$90 + Asset C \$270).

Further, because of the removal of Asset B, ABC reevaluates whether it is appropriate to continue to combine Asset A and Asset C in a single unit of account (see [Question 3.2.10](#)).



Question 9.2.20
Does an impairment loss related to an indefinite-lived intangible asset indicate that it may no longer have an indefinite life?

Interpretive response: It depends. The impairment of an indefinite-lived intangible asset may (depending on the impairment’s cause) indicate that its useful life no longer extends beyond the foreseeable horizon. This may mean that the asset no longer has an indefinite life. For example, an impairment caused by a change in law that opens up previously protected markets to increased competition might indicate that a mature brand no longer has an indefinite useful life.

9.3 Long-lived assets



Excerpt from ASC 360-10

- > Adjusted Carrying Amount Becomes New Cost Basis

35-20 If an impairment loss is recognized, the adjusted carrying amount of a long-lived asset shall be its new cost basis. For a depreciable long-lived asset, the new cost basis shall be depreciated (amortized) over the remaining useful life of that asset. Restoration of a previously recognized impairment loss is prohibited.

- > Allocating Impairment Losses to an Asset Group

35-28 An impairment loss for an asset group shall reduce only the carrying amounts of a long-lived asset or assets of the group. The loss shall be allocated to the long-lived assets of the group on a pro rata basis using the relative carrying amounts of those assets, except that the loss allocated to an individual long-lived asset of the group shall not reduce the carrying amount of that asset below its fair value whenever that fair value is determinable without undue cost and effort. See Example 1 (paragraph 360-10-55-20) for an illustration of this guidance.



Question 9.3.10

How is an impairment loss allocated within an asset group?

Interpretive response: The carrying amount of an asset group will generally comprise many assets that are in the scope of the Topic 360 impairment test (long-lived assets) and some that are not (e.g. working capital); see [Question 2.4.20](#).

As shown in the diagram, the impairment loss calculated for the asset group is allocated only to those assets that are in the scope of the Topic 360 impairment model. [360-10-35-28]

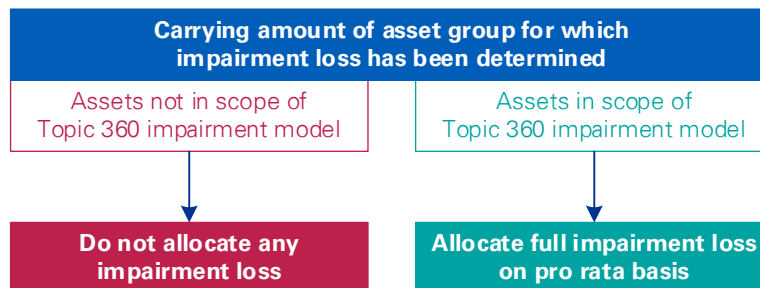

The pro rata allocation of the impairment loss is based on the relative carrying amount of each of the underlying long-lived assets. However, no individual long-

lived asset is written down to below its fair value – if that fair value can be determined without undue cost and effort. [360-10-35-28]

In general, we believe the fair value of individual long-lived assets should usually be determinable either individually or in aggregate without undue cost and effort.

After the impairment loss is allocated, some long-lived assets will be recorded at their fair value and others could be recorded at a carrying amount in excess of their fair value.



Example 9.3.10

Impairment loss allocation within an asset group

Following an indicator of impairment, ABC Corp. tested an asset group for impairment and determined that the carrying amount of the asset group (\$1,600) was in excess of its fair value (\$1,400). As a result, ABC allocates the impairment loss to the long-lived assets in the asset group, based on their relative carrying amounts.

Scenario 1: Fair value of individual long-lived assets cannot be determined without undue cost and effort

In this scenario, ABC cannot determine the fair value of any of the individual long-lived assets in the asset group. Therefore, the impairment loss is allocated on a pro rata basis to all assets except the working capital, which is not in the scope of the Topic 360 impairment model.

	C/Amt before	Impairment allocation (rounded)	C/Amt after
Building	\$ 800	$\$200 \times (\$800 / \$1,350) = \119	\$ 681
Equipment	350	$\$200 \times (\$350 / \$1,350) = \52	298
Customer relationships	200	$\$200 \times (\$200 / \$1,350) = \29	171
Working capital	250	No allocation	250
Total	\$1,600		\$1,400

Scenario 2: Fair value of an individual long-lived asset can be determined without undue cost and effort

In this scenario, ABC is able to determine the fair value of the building (\$700) without undue cost and effort; this follows a recent appraisal of the site. Therefore, the impairment loss is allocated to the long-lived assets on a pro rata basis except that the loss allocated to the building is limited to \$100 (\$800 - \$700).

As shown in the table, the deficit that cannot be allocated to the building (\$19) is instead allocated to the other long-lived assets, based on their relative carrying amounts.

	C/Amt before	Impairment allocation (rounded)	C/Amt after
Building	\$ 800	$\$200 \times (\$800 / \$1,350) = \119 Limited to \$100	\$ 700
Equipment	350	$[\$200 \times (\$350 / \$1,350)] +$ $[\$19 \times (\$350 / \$550)] = \64	286
Customer relationships	200	$[\$200 \times (\$200 / \$1,350)] +$ $[\$19 \times (\$200 / \$550)] = \36	164
Working capital	250	No allocation	250
Total	\$1,600		\$1,400



Excerpt from ASC 360-10

- > Example 1: Allocation of Impairment Loss

55-20 This Example illustrates the allocation of an impairment loss to the long-lived assets of an **asset group** (see paragraph 360-10-35-28).

55-21 An entity owns a manufacturing facility that together with other assets is tested for recoverability as a group. In addition to long-lived assets (Assets A–D), the asset group includes inventory measured using first-in, first-out (FIFO), which is reported at the lower of cost and **net realizable value** in accordance with Topic 330, and other current assets and liabilities that are not covered by this Subtopic. The \$2.75 million aggregate carrying amount of the asset group is not recoverable and exceeds its fair value by \$600,000. In accordance with paragraph 360-10-35-28, the impairment loss of \$600,000 would be allocated as shown below to the long-lived assets of the group.

Asset Group	Carrying Amount (in \$ 000s)	Pro Rata Allocation Factor	Allocation of Impairment (Loss) (in \$ 000s)	Adjusted Carrying Amount (in \$ 000s)
Current assets	\$ 400	-	\$ -	\$ 400
Liabilities	(150)	-	-	(150)
Long-lived assets:				
Asset A	590	24%	(144)	446
Asset B	780	31	(186)	594
Asset C	950	38	(228)	722
Asset D	180	7	(42)	138
Subtotal—long-lived assets	2,500	100	(600)	1,900
Total	\$ 2,750	100%	\$ (600)	\$ 2,150

55-22 If the fair value of an individual long-lived asset of an asset group is determinable without undue cost and effort and exceeds the adjusted carrying amount of that asset after an impairment loss is allocated initially, the excess impairment loss initially allocated to that asset would be reallocated to the other long-lived assets of the group. For example, if the fair value of Asset C is \$822,000, the excess impairment loss of \$100,000 initially allocated to that asset (based on its adjusted carrying amount of \$722,000) would be reallocated

as shown below to the other long-lived assets of the group on a pro rata basis using the relative adjusted carrying amounts of those assets.

Long-Lived Assets of Asset Group	Adjusted Carrying Amount (in \$ 000s)	Pro Rata Reallocation Factor	Reallocation of Excess Impairment (Loss) (in \$ 000s)	Adjusted Carrying Amount after Reallocation (in \$ 000s)
Asset A	\$ 446	38%	\$ (38)	\$ 408
Asset B	594	50	(50)	544
Asset D	138	12	(12)	126
Subtotal	1,178	100%	(100)	1,078
Asset C	722		100	822
Total—long-lived assets	\$ 1,900		\$ -	\$ 1,900



Question 9.3.20

Does the sale of a held-and-used long-lived asset soon after the asset group is tested for impairment affect the allocation of an impairment loss?

Interpretive response: No. An entity may intend to sell a long-lived asset within the impaired asset group in the foreseeable future, but the asset does not meet the held-for-sale criteria at the time of the impairment test. Topic 360 does not permit an entity to write down an asset to its individual fair value (if below the proportional impairment allocation) and allocate less of the loss to the carrying amounts of other long-lived assets in the group.

Therefore, if the entity sells the asset from the asset group a short time after the impairment loss, the entity recognizes any additional loss at the time of the sale.



Question 9.3.30

In addition to writing down a long-lived asset for impairment, what other accounting implications are there?

Interpretive response: In performing the Step 1 recoverability test, an entity considers the useful life of the primary asset, and the salvage value of the assets in the group, as part of the process of estimating future cash flows (see [Question 7.3.50](#)). However, the accounting for the asset itself is not adjusted before the recognition of any impairment loss. [\[360-10-35-22\]](#)

Therefore, once an impairment loss has been recognized, the entity should make any adjustments to the useful life of the primary asset and/or salvage value of the assets in the group that were identified during the impairment process.

Note: US GAAP does not specifically require an entity to review depreciation estimates, such as useful lives, or methods of depreciation on an annual basis. We believe an entity should periodically assess useful life and salvage value

estimates for long-lived assets, regardless of whether impairment indicators exist under Topic 360 to ensure the policies and methods established at acquisition continue to be appropriate.



Question 9.3.40

Can an impairment loss on a long-lived asset be reversed in the future if circumstances change?

Interpretive response: No. Once an impairment loss is recognized, it cannot be reversed. The reduced carrying amount of the asset becomes its new cost basis – i.e. the impairment loss and any accumulated depreciation is written off against the gross carrying amount of the asset. The new cost basis is then depreciated (or amortized) over the asset’s remaining useful life. [360-10-35-20]



Example 9.3.20

New cost basis after impairment loss

ABC Corp. paid \$1,000 for a piece of production equipment, which had a carrying amount of \$800 at the beginning of the period. Following an impairment test, ABC recognizes an impairment loss of \$250.

The following table shows the recognition of the impairment loss, and the reversal of accumulated depreciation to set a new cost basis that becomes the basis for future accounting.

	Cost	Accum depn	Impairment	Carrying amount
Opening carrying amount	\$1,000	\$(200)		\$ 800
Impairment loss			\$(250)	(250)
Adjusted carrying amount				\$ 550
Reset adjustments against cost	(450)	\$200	\$250	–
New cost basis	\$ 550			

9.4 Goodwill

9.4.10 Recognizing and allocating an impairment loss



Excerpt from ASC 350-20

- > Quantitative Assessment

35-4 The quantitative goodwill impairment test, used to identify both the existence of impairment and the amount of impairment loss, compares the fair value of a reporting unit with its carrying amount, including goodwill.

35-5 The guidance in paragraphs 350-20-35-22 through 35-24 shall be considered in determining the fair value of a reporting unit.

35-6 If the fair value of a reporting unit exceeds its carrying amount, goodwill of the reporting unit is considered not impaired.

35-8 If the carrying amount of a reporting unit exceeds its fair value, an impairment loss shall be recognized in an amount equal to that excess, limited to the total amount of goodwill allocated to that reporting unit. Additionally, an entity shall consider the income tax effect from any tax deductible goodwill on the carrying amount of the reporting unit, if applicable, in accordance with paragraph 350-20-35-8B when measuring the goodwill impairment loss.

35-8B If a reporting unit has tax deductible goodwill, recognizing a goodwill impairment loss may cause a change in deferred taxes that results in the carrying amount of the reporting unit immediately exceeding its fair value upon recognition of the loss. In those circumstances, the entity shall calculate the impairment loss and associated deferred tax effect in a manner similar to that used in a business combination in accordance with the guidance in paragraphs 805-740-55-9 through 55-13. The total loss recognized shall not exceed the total amount of goodwill allocated to the reporting unit. See Example 2A in paragraphs 350-20-55-23A through 55-23C for an illustration of the calculation.

35-12 After a goodwill impairment loss is recognized, the adjusted carrying amount of goodwill shall be its new accounting basis.

35-13 Subsequent reversal of a previously recognized goodwill impairment loss is prohibited once the measurement of that loss is recognized.

When an impairment loss is recognized, the amount of the loss reduces the carrying amount of the goodwill in the affected reporting unit, but not below zero. Once recognized, an impairment loss cannot be reversed. [350-20-35-12 – 35-13]



Question 9.4.10

How can the impairment test for long-lived assets in a reporting unit affect the amount of goodwill impairment loss?

Background: All assets in a reporting unit that require impairment testing are tested for impairment *before* goodwill is tested – this includes, but is not limited to, long-lived assets. The carrying amounts of assets are decreased for any impairment losses, with a corresponding adjustment to the adjusted carrying amount of the reporting unit in which those assets reside. For further discussion, see [section 4.4. \[350-20-35-31\]](#)

Interpretive response: The effect of the pre-goodwill impairment analysis is that the carrying amount of the reporting unit is less likely to exceed its fair value. An impairment of goodwill is recorded only when the reporting unit's fair value is less than its carrying amount after completing all other impairment tests.

Under the Topic 360 impairment model, it is possible for a long-lived asset's fair value to be less than its carrying amount, but for the carrying amount to be fully recoverable on an undiscounted cash flow basis (see [chapter 7](#)). In that case, no impairment loss would be recognized on the long-lived assets. However, assuming the fair value of all the other assets and liabilities of the reporting unit equal their carrying amounts, the long-lived asset passing the recoverability test might cause a goodwill impairment loss.



Example 9.4.10

Long-lived assets tested for impairment before goodwill

ABC Corp. is testing the goodwill of Reporting Unit for impairment at its annual impairment testing date. The following values related to Reporting Unit are relevant:

- Carrying amount (total), \$1,500
- Carrying amount of goodwill, \$750
- Carrying amount of long-lived assets, \$450
- Fair value, \$1,300

While performing a qualitative assessment to determine whether it is more likely than not that goodwill is impaired (see [chapter 6](#)), management becomes aware that the long-lived assets within Reporting Unit may be impaired. Therefore, ABC needs to test the related asset groups for impairment before testing goodwill.

Scenario 1: Long-lived assets not impaired

ABC performs a Step 1 recoverability test (see [chapter 7](#)) and concludes that the long-lived assets are not impaired. Therefore, no adjustment is required to the carrying amounts of the long-lived assets. As a result, ABC writes down goodwill by \$200 (\$1,500 - \$1,300).

Scenario 2: Long-lived assets impaired

ABC performs a Step 1 recoverability test and concludes that the long-lived assets are impaired. Completion of the Step 2 fair value test results in the long-lived assets being written down by \$250 – i.e. their new carrying amount is \$200 (\$450 - \$250).

The fair value of Reporting Unit (\$1,300) is now compared to its adjusted carrying amount of \$1,250 (\$1,500 - \$250 impairment loss). Compared to Scenario 1, there is now excess value of \$50 and goodwill is not impaired.



Example 9.4.20

Long-lived assets tested for impairment before goodwill – asset group equals reporting unit

ABC Corp. has an asset group that is also a reporting unit (see Question 3.3.10).

The following values are relevant:

- Carrying amount of asset group/reporting (total), \$2,000
- Carrying amount of goodwill, \$1,000
- Carrying amount of long-lived assets, \$1,000
- Fair value, \$1,100

In this example, the carrying amounts of the asset group and reporting unit are the same (i.e. including goodwill) because the units of account are the same (see Question 5.3.10). In addition, ABC is able to determine the fair value of the long-lived assets (\$800) without undue cost and effort.

As shown in the table, the impairment of the long-lived assets is limited to \$200 (\$1,000 - \$800). This means that the additional \$700 of impairment is allocated to goodwill when the fair value of the reporting unit (\$1,100) is compared to its carrying amount after recognizing the Topic 360 impairment loss (\$1,800).

	Long-lived assets	Goodwill	Total
Opening carrying amounts	\$1,000	\$1,000	\$2,000
Topic 360 impairment loss	(200)		(200)
Adjusted carrying amounts	<u>\$ 800</u>		<u>\$1,800</u>
Subtopic 350-20 impairment loss		(700)	(700)
Adjusted carrying amounts		<u>\$ 300</u>	<u>\$1,100</u>

9.4.20 Allocating an impairment loss to goodwill components for tax purposes

Goodwill recognized in a business combination may be deductible for income tax purposes (i.e. tax-deductible goodwill). This typically results when goodwill for book purposes differs from the amount assigned for tax purposes because

of different valuation and allocation rules and differences in determining the amount of consideration transferred (i.e. different treatment of costs incurred for a transaction).

This section explains the income tax aspects resulting from goodwill impairment. For further discussion, see section 10 of KPMG Handbook, [Accounting for income taxes](#).



Question 9.4.20

What are the components of goodwill for income tax accounting purposes?

Interpretive response: Goodwill is separated into two components to facilitate the accounting for basis differences associated with goodwill. This determination is made in the acquisition accounting and is not subsequently reevaluated.

- The **first component** of goodwill equals the lesser of goodwill for financial statement purposes and tax-deductible goodwill. In performing this calculation, tax-deductible goodwill includes any carryover-tax-deductible goodwill of the acquiree.
- The **second component** of goodwill is the remainder of any goodwill for financial statement purposes or tax purposes. This is frequently the full amount of the financial statement goodwill for nontaxable business combinations.
 - If the second component of goodwill is ‘excess financial statement goodwill’, it is typically referred to as nondeductible goodwill.
 - If the second component of goodwill is excess tax-deductible goodwill, it is typically referred to as second component tax goodwill. [\[805-740-25-8\]](#)

The following diagram illustrates two scenarios.

- In Scenario 1, tax-deductible goodwill is less and is designated as first component goodwill; the excess of financial statement goodwill is second component goodwill. Only the first component is tax-deductible.
- In Scenario 2, financial statement goodwill is less and is designated as first component goodwill; the excess of tax-deductible goodwill is second component goodwill. Both components are tax-deductible.

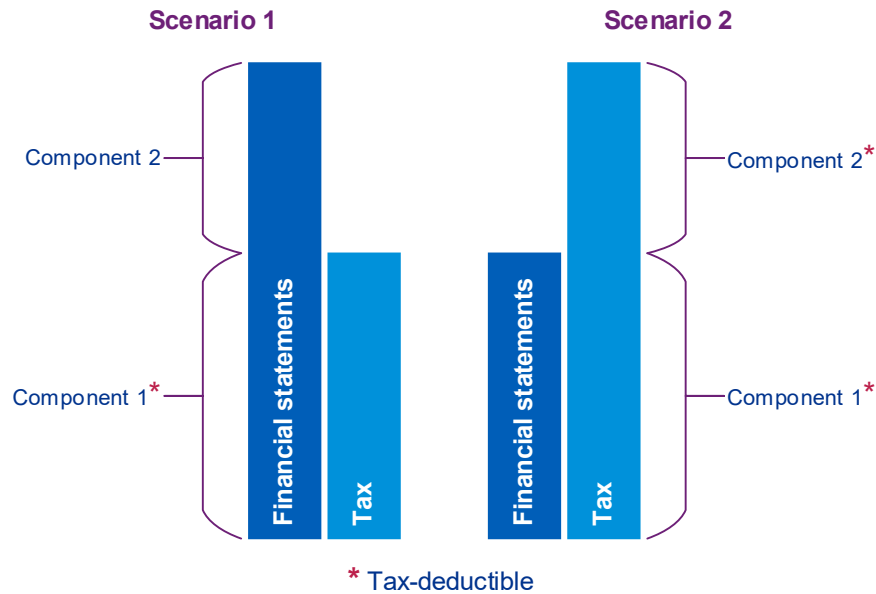

For nontaxable business combinations – i.e. the acquiree’s tax bases of the individual assets acquired and liabilities assumed are carried over by the acquiring entity (see [Question 8.3.60](#)) – the first component of goodwill is frequently zero.

Example 9.4.30 First and second component goodwill

In this example, four scenarios illustrate the calculation of first component versus second component goodwill.

	Financial statements	Tax basis
Scenario 1		
Only \$600 of the total goodwill of \$800 is tax-deductible.		
First component	600	600
Second component	200	–
Total goodwill	800	600
Scenario 2		
Tax-deductible goodwill exceeds the amount recognized in the financial statements.		
First component	600	600
Second component	–	200
Total goodwill	600	800

	Financial statements	Tax basis
Scenario 3		
None of the goodwill is tax-deductible. The excess amount is typically referred to as 'nondeductible goodwill'.		
First component	--	--
Second component	800	--
Total goodwill	800	--
Scenario 4		
No goodwill is recognized in the financial statements. The excess amount is typically referred to as 'second component tax goodwill'.		
First component	--	--
Second component	--	800
Total goodwill	--	800

 **Question 9.4.30**
Does an impairment loss always have a related tax effect?

Interpretive response: No. If an entity's impaired goodwill is nondeductible – i.e. there is only second component goodwill (see [Example 9.4.30](#), Scenario 3) – the impairment loss is recognized with no related income tax effect.

Alternatively, if there is only first component goodwill – or a portion of the impairment loss has been allocated to first component goodwill – there will be a tax effect (see [Example 9.4.30](#), Scenario 2). The related tax benefit either creates a deferred tax asset or reduces an existing deferred tax liability, which would increase the carrying amount of Reporting Unit above its fair value – triggering further impairment.

To solve this circular problem, an entity calculates its impairment loss and associated deferred tax effect using the simultaneous equation used in business combinations. The adjustment to deferred taxes and to the initial impairment loss is calculated as follows. [350-20-35-8B]

$$(\text{tax rate} \div (1 - \text{tax rate})) \times \text{initial impairment loss}$$

This calculation is illustrated in [Examples 9.4.40](#) and [9.4.50](#).

[Question 9.4.60](#) addresses more complex situations.



Example 9.4.40
Goodwill impairment – taxable transaction

ABC Corp. is performing a goodwill impairment test for Reporting Unit, which has the following assets and liabilities:

- Net assets (excluding goodwill and deferred taxes), \$600
- Tax bases of net assets, \$350
- Goodwill, \$400
- Net deferred tax liabilities, \$50

The fair value of Reporting Unit is \$800. ABC assumed a taxable transaction because it yielded the highest economic value (see [section 8.3.30](#)). ABC has a tax rate of 21%.

As shown in the table, ABC calculates an impairment loss of \$150.

Net assets (excluding goodwill and deferred taxes)	\$600
Deferred taxes (see section 5.4.50)	(50)
Goodwill	400
Carrying amount of Reporting Unit	950
Fair value	800
Impairment loss	\$150

Scenario 1: Goodwill is nondeductible

ABC’s goodwill is nondeductible. Therefore, the impairment loss of \$150 is recognized with no related income tax effect.

Scenario 2: Goodwill is deductible

All of ABC’s goodwill is first component goodwill. Therefore, ABC applies the simultaneous equation to determine the amount of deferred tax and the adjustment to the initial \$150 impairment loss.

$$\begin{aligned}
 & (\text{tax rate} \div (1 - \text{tax rate})) \times \text{initial impairment loss} \\
 & (21\% \div (1 - 21\%)) \times \$150 = \$40
 \end{aligned}$$

Therefore, an adjustment of \$40 is required – the impairment loss is \$190 (\$150 + \$40) and the related tax effect is \$40.



Example 9.4.50
Goodwill impairment – nontaxable transaction

Assume the same facts as in Example 9.4.40 except that the fair value of Reporting Unit is \$850. In this example, ABC Corp. assumed a nontaxable transaction because it yielded the highest economic value (see [section 8.3.30](#)).

This changes ABC’s calculation of the impairment loss as follows.

Carrying amount of Reporting Unit	\$950
Fair value	850
Impairment loss	\$100

Scenario 1: Goodwill is nondeductible

ABC’s goodwill is nondeductible. Therefore, the impairment loss of \$100 is recognized with no related income tax effect.

Scenario 2: Goodwill is deductible

All of ABC’s goodwill is first component goodwill. Therefore, ABC applies the simultaneous equation to determine the amount of deferred tax and the adjustment to the initial \$100 impairment loss.

$$\begin{aligned} & (\text{tax rate} \div (1 - \text{tax rate})) \times \text{initial impairment loss} \\ & (21\% \div (1 - 21\%)) \times \$100 = \$27 \end{aligned}$$

Therefore, an adjustment of \$27 is required – the impairment loss is \$127 (\$100 + \$27) and the related tax effect is \$27.



Excerpt from ASC 350-20

- > Example 1: Impairment Test When either a Taxable or Nontaxable Transaction Is Feasible
- • > Case A—Effect of a Nontaxable Transaction on the Impairment Test of Goodwill

55-10 This Example illustrates the effect of a nontaxable transaction on the impairment test of goodwill. The Example may not necessarily be indicative of actual income tax liabilities that would arise in the sale of a reporting unit or the relationship of those liabilities in a taxable versus nontaxable structure.

55-11 Entity A is performing a goodwill impairment test relative to Reporting Unit at December 31, 20X2. Reporting Unit has the following assets and liabilities:

- a. Net assets (excluding goodwill and deferred income taxes) of \$60 with a tax basis of \$35
- b. Goodwill of \$40
- c. Net deferred tax liabilities of \$10

55-12 Entity A believes that it is feasible to sell Reporting Unit in either a nontaxable or a taxable transaction. Entity A could sell Reporting Unit for \$80 in a nontaxable transaction or \$90 in a taxable transaction. If Reporting Unit were sold in a nontaxable transaction, Entity A would have a current tax payable resulting from the sale of \$10. Assuming a tax rate of 40 percent, if Reporting Unit were sold in a taxable transaction, Entity A would have a current tax payable resulting from the sale of \$22 $(\$90 - 35) \times 40\%$.

55-13 In the quantitative impairment test in paragraphs 350-20-35-4 through 35-8, Entity A concludes that market participants would act in their economic best interest by selling Reporting Unit in a nontaxable transaction based on the following evaluation of its expected after-tax proceeds.

	<u>Nontaxable</u>	<u>Taxable</u>
Gross proceeds (fair value)	\$ 80	\$ 90
Less: taxes arising from transaction	(10)	(22)
Value to Entity A	<u>\$ 70</u>	<u>\$ 68</u>

55-14 In the quantitative impairment test, Entity A would determine the carrying amount of Reporting Unit as follows.

Net assets	\$ 60
Goodwill	40
Deferred taxes	(10)
Carrying value	<u>\$ 90</u>

55-15 The goodwill allocated to Reporting Unit is determined to be impaired because Reporting Unit's carrying value (\$90) exceeds its fair value (\$80 assuming a nontaxable transaction).

55-16 Reporting Unit must recognize the full goodwill impairment loss of \$10 (determined as the excess of the carrying amount of Reporting Unit of \$90 compared with its fair value of \$80) because the \$10 impairment loss does not exceed the \$40 carrying amount of the goodwill allocated to Reporting Unit.

- > Example 2: Impairment Test When Either a Taxable or Nontaxable Transaction Is Feasible
- > Case B—Effect of a Taxable Transaction on the Impairment Test of Goodwill

55-17 This Example illustrates the effect of a taxable transaction on the impairment test of goodwill. The Example may not necessarily be indicative of actual income tax liabilities that would arise in the sale of a reporting unit or the relationship of those liabilities in a taxable versus nontaxable structure.

55-18 Entity A is performing a goodwill impairment test relative to Reporting Unit at December 31, 20X2. Reporting Unit has the following assets and liabilities:

- a. Net assets (excluding goodwill and deferred income taxes) of \$60 with a tax basis of \$35
- b. Goodwill of \$40
- c. Net deferred tax liabilities of \$10.

55-19 Entity A believes that it is feasible to sell Reporting Unit in either a nontaxable or a taxable transaction. Entity A could sell Reporting Unit for \$65 in a nontaxable transaction or \$80 in a taxable transaction. If Reporting Unit were sold in a nontaxable transaction, Entity A would have a current tax payable resulting from the sale of \$4. Assuming a tax rate of 40 percent, if Reporting Unit were sold in a taxable transaction, Entity A would have a current tax payable resulting from the sale of \$18 ($[\$80 - 35] \times 40\%$).

55-20 In the quantitative impairment test in paragraphs 350-20-35-4 through 35-8, Entity A concludes that market participants would act in their economic

best interest by selling Reporting Unit in a taxable transaction. This conclusion was based on the following.

	Nontaxable Transaction	Taxable Transaction
Gross proceeds (fair value)	\$ 65	\$ 80
Less: taxes arising from transaction	(4)	(18)
Value to Entity A	<u>\$ 61</u>	<u>\$ 62</u>

55-21 Deferred taxes related to the net assets of Reporting Unit should be included in the carrying value of Reporting Unit. Accordingly, in the quantitative impairment test Entity A would determine the carrying amount of Reporting Unit as follows.

Net assets	\$ 60
Goodwill	40
Deferred income taxes	(10)
Carrying value	<u>\$ 90</u>

55-22 The goodwill allocated to Reporting Unit is determined to be impaired because Reporting Unit's carrying amount (\$90) exceeds its fair value (\$80).

55-23 Reporting Unit must recognize the full goodwill impairment loss of \$10 (determined as the excess of the carrying amount of Reporting Unit of \$90 compared with its fair value of \$80) because the \$10 impairment loss does not exceed the \$40 carrying amount of the goodwill allocated to Reporting Unit.

- > Example 2A: Impairment Test When Goodwill Is Tax Deductible

55-23A Goodwill is deductible for tax purposes for some business combinations in certain jurisdictions. In those jurisdictions, a deferred tax asset or deferred tax liability is recorded upon acquisition on the basis of the difference between the book basis and the tax basis of goodwill. When goodwill of a reporting unit is tax deductible, the impairment of goodwill creates a cycle of impairment because the decrease in the book value of goodwill increases the deferred tax asset (or decreases the deferred tax liability) such that the carrying amount of the reporting unit increases. However, there is no corresponding increase in the fair value of the reporting unit and this could trigger another impairment test.

55-23B This Example illustrates the use of a simultaneous equation when tax deductible goodwill is present to account for the increase in the carrying amount from the deferred tax benefit.

Beta Entity has goodwill from an acquisition in Reporting Unit X. All of the goodwill allocated to Reporting Unit X is tax deductible. On October 1, 20X6 (the date of the annual impairment test for the reporting unit), Reporting Unit X had a book value of goodwill of \$400, which is all tax deductible, deferred tax assets of \$200 relating to the tax-deductible goodwill, and book value of other net assets of \$400. Reporting Unit X is subject to a 40 percent income tax rate. Beta Entity estimated the fair value of Reporting Unit X at \$900.

	Carrying Amount	Fair Value	Preliminary Impairment	Preliminary Deferred Tax Adjustment	Carrying Amount after Preliminary Impairment
Goodwill	\$ 400	\$ -	\$ (100)	\$ -	\$ 300
Deferred taxes	200	-	-	40	240
Other net assets	400	-	-	-	400
Total	\$ 1,000	\$ 900	\$ (100)	\$ 40	\$ 940

55-23C In the Example above, the carrying amount of Reporting Unit X immediately after the impairment charge exceeds its fair value by the amount of the increase in the deferred tax asset calculated as 40 percent of the impairment charge. To address the circular nature of the carrying amount exceeding the fair value, instead of continuing to calculate impairment on the excess of carrying amount over fair value until those amounts are equal, Beta Entity would apply the simultaneous equation demonstrated in paragraphs 805-740-55-9 through 55-13 to Reporting Unit X, as follows.

Simultaneous equation: $[\text{tax rate}/(1 - \text{tax rate})] \times (\text{preliminary temporary difference} = \text{deferred tax asset})$

Equation for this example: $40\%(1 - 40\%) \times 100 = 67$

	Carrying Amount	Fair Value	Preliminary Impairment	Adjustment for Equation	Carrying Amount after Impairment
Goodwill	\$ 400	\$ -	\$ (100)	\$ (67)	\$ 233
Deferred taxes	200	-	-	67	267
Other net assets	400	-	-	-	400
Total	\$ 1,000	\$ 900	\$ (100)	\$ 0	\$ 900

55-23D The company would report a \$167 goodwill impairment charge partially offset by a \$67 deferred tax benefit recognized in the income tax line. If the impairment charge calculated using the equation exceeds the total goodwill allocated to a reporting unit, the total impairment charge would be limited to the goodwill amount.



Question 9.4.40

Is the recoverability of deferred tax assets assessed before or after applying the simultaneous equation?

Interpretive response: We believe an entity should assess the need for a valuation allowance related to a deferred tax asset only after it has applied the simultaneous equation and recognized the gross amount of the deferred tax asset. Once the impairment loss is recognized, the entity should consider the realizability of the deferred tax asset following the general principles of Topic 740.

This approach is consistent with the general principle in Topic 740 of recognizing all deferred tax assets and only then determining the need for a valuation allowance. It also ensures that the full goodwill impairment loss is recognized in accordance with Subtopic 350-20. [\[350-20-35-8B\]](#)



Question 9.4.50

How is the impairment loss allocated when the simultaneous equation results in the loss exceeding the goodwill balance?

Interpretive response: In some cases, the calculated goodwill impairment loss (resulting from the simultaneous equation) exceeds the total amount of goodwill allocated to the reporting unit. This creates a conflict because paragraph 350-20-35-8 limits the impairment loss to the total amount of goodwill allocated to the reporting unit.

In that case, we believe an entity should limit its recognized impairment loss to the financial statement carrying amount of goodwill allocated to the reporting unit and adjust the associated deferred tax benefit so that the ending deferred tax balance is equal to the post-impairment temporary difference times the tax rate. The ending deferred tax asset should be assessed for realizability under Topic 740.



Example 9.4.60

Tax-deductible goodwill fully impaired

ABC Corp. is performing a goodwill impairment test for Reporting Unit and concludes that goodwill is impaired. ABC's tax rate is 21%. The following additional information is relevant to Reporting Unit:

- Financial statement carrying amount of goodwill, \$350
- Tax basis of goodwill, \$825

ABC calculates an initial impairment loss of \$300, and then applies the simultaneous equation to determine the amount of the adjustment to deferred tax and to the initial impairment loss.

$$\begin{aligned} & (\text{tax rate} \div (1 - \text{tax rate})) \times \text{initial impairment loss} \\ & (21\% \div (1 - 21\%)) \times \$300 = \$80 \end{aligned}$$

Therefore, the adjusted impairment loss is \$380 (\$300 + \$80). However, the carrying amount of goodwill is only \$350, which leaves \$30 of unallocated impairment loss.

To account for the additional loss of \$30, ABC adjusts the deferred tax effect so that the ending deferred tax asset is equal to the post-impairment temporary difference times the tax rate. The following table shows the adjustments.

	Goodwill	DTA
Opening carrying amounts	\$ 350	\$100
Full impairment loss	(380)	80 ¹
Goodwill deficit	(30)	
Adjustment to avoid negative goodwill	30	(7) ²
Final carrying amounts	\$ 0	\$173 ³
Notes:		
1.	\$380 × 21%.	
2.	\$30 × 21% (rounded up).	
3.	(\$825 - \$0) × 21%.	

 **Question 9.4.60**
How is an impairment loss allocated to the components of goodwill?

Interpretive response:

Impairment causes first component tax goodwill to exceed first component financial statement goodwill

If the first component financial statement goodwill becomes impaired such that first component tax goodwill exceeds the first component financial statement goodwill, a deferred tax asset should be recognized. An impairment of first component financial statement goodwill may also result in a reduction of a deferred tax liability that was recognized for an excess of first component financial statement goodwill over first component tax goodwill before the impairment loss.

Reporting unit has second component financial statement goodwill

If a reporting unit has second component financial statement goodwill (nondeductible goodwill), the goodwill impairment could be allocated using the methods used to reflect amortization of tax-deductible goodwill. These are discussed in paragraph 10.018a of KPMG Handbook, [Accounting for income taxes](#).

- **Method A.** To the extent possible, allocate the impairment loss to any second component financial statement goodwill. Allocate any remaining impairment loss to first component goodwill.
- **Method B.** Allocate the impairment on a pro rata basis to the reporting unit's first component and second component financial statement goodwill.

An offsetting deferred tax asset (or reduction in a deferred tax liability) is recognized only for the impairment loss allocated to the reporting unit's first

component financial statement goodwill. There is no tax effect from the impairment of nondeductible goodwill (second component financial statement goodwill). Therefore, an entity that has elected Method A would recognize \$0 tax effect if the goodwill impairment amount was less than or equal to the second component financial statement goodwill.

In applying Method B, sometimes the calculated goodwill impairment loss (resulting from the simultaneous equation) exceeds first component financial statement goodwill when there is also second component financial statement goodwill. In that case, we believe the excess should be allocated to second component financial statement goodwill.



Example 9.4.70

Goodwill impairment – complex scenarios

ABC Corp. is performing a goodwill impairment test for Reporting Unit and concludes that goodwill is impaired by \$350. ABC's tax rate is 21%.

Scenario 1: Tax goodwill exceeds financial statement goodwill

ABC's goodwill and related deferred taxes before impairment are as follows.

	Financial statements	Tax basis	DTA/(DTL)
First component	\$600	\$600	\$ --
Second component	--	300	63
Total goodwill	\$600	\$900	\$63

ABC applies the simultaneous equation to determine the amount of the deferred tax asset and the adjustment to the initial \$350 impairment loss.

$$(\text{tax rate} \div (1 - \text{tax rate})) \times \text{initial impairment loss}$$

$$(21\% \div (1 - 21\%)) \times \$350 = \$93$$

Therefore, a deferred tax asset of \$93 is recognized, and the impairment loss is \$443 (\$350 + \$93). ABC's goodwill and related deferred taxes after impairment are as follows.

	Financial statements	Tax basis	DTA/(DTL)
First component	\$157 ¹	\$600	\$93 ²
Second component	--	300	63
Total goodwill	\$157	\$900	\$156
Notes:			
1.	\$600 - \$443.		
2.	(\$600 - \$157) × 21%.		

Scenario 2: First component financial statement goodwill exceeds first component tax goodwill

ABC's goodwill and related deferred taxes before impairment are as follows.

	Financial statements	Tax basis	DTA/(DTL)
First component	\$600	\$200	\$(84)
Second component	--	--	--
Total goodwill	\$600	\$200	\$(84)

As in Scenario 1, ABC applies the simultaneous equation to determine an adjustment (debit) to the existing deferred tax liability of \$93, and an impairment loss of \$443 (\$350 + \$93). ABC's goodwill and related deferred taxes after impairment are as follows.

	Financial statements	Tax basis	DTA/(DTL)
First component	\$157 ¹	\$200	\$9 ²
Second component	--	--	--
Total goodwill	\$157	\$200	\$9
Notes:			
1.	\$600 - \$443.		
2.	(\$200 - \$157) × 21%.		

Scenario 3: Reporting unit has second component financial statement goodwill

ABC's goodwill and related deferred taxes before impairment are as follows.

	Financial statements	Tax basis	DTA/(DTL)
First component	\$ 900	\$800	\$(21)
Second component	300	--	--
Total goodwill	\$1,200	\$800	\$(21)

Because ABC has excess financial statement goodwill, it could apply Method A or Method B outlined in [Question 9.4.60](#).

Method A

The impairment loss of \$350 is allocated to second component financial statement goodwill to the extent possible – i.e. a loss of \$300 is allocated to reduce it to zero. There is no related income tax effect.

The remaining \$50 is allocated to first component financial statement goodwill. ABC applies the simultaneous equation to determine the adjustment to deferred tax and to the initial \$50 impairment loss.

$$\begin{aligned} & (\text{tax rate} \div (1 - \text{tax rate})) \times \text{initial impairment loss} \\ & (21\% \div (1 - 21\%)) \times \$50 = \$13 \end{aligned}$$

Therefore, the adjustment (debit) to the existing deferred tax liability is \$13, and the impairment loss is \$63 (\$50 + \$13). ABC's goodwill and related deferred taxes after impairment are as follows.

	Financial statements	Tax basis	DTA/(DTL)
First component	\$837 ¹	\$800	\$8 ²
Second component	—	—	—
Total goodwill	\$837	\$800	\$8
Notes:			
1.	\$900 - \$63.		
2.	(\$837 - \$800) × 21%.		

Method B

The impairment loss of \$350 is allocated on a pro rata basis to the first component and second component financial statement goodwill (rounded):

- First component: $\$350 \times (\$900 / \$1,200) = \263
- Second component: $\$350 \times (\$300 / \$1,200) = \87

There is no related income tax effect for the impairment loss of \$87 allocated to second component financial statement goodwill.

ABC applies the simultaneous equation to determine the adjustment to deferred tax and to the initial impairment loss for the \$263 allocated to first component financial statement goodwill.

$$\begin{aligned} & (\text{tax rate} \div (1 - \text{tax rate})) \times \text{initial impairment loss} \\ & (21\% \div (1 - 21\%)) \times \$263 = \$70 \end{aligned}$$

Therefore, the adjustment (debit) to the existing deferred tax liability is \$70, and the impairment loss is \$333 (\$263 + \$70). ABC's goodwill and related deferred taxes after impairment are as follows.

	Financial statements	Tax basis	DTA/(DTL)
First component	\$567 ¹	\$800	\$49 ²
Second component	213 ³	—	—
Total goodwill	\$780	\$800	\$49
Notes:			
1.	\$900 - \$333.		
2.	(\$800 - \$567) × 21%.		
3.	\$300 - \$87.		



Question 9.4.70

How is a goodwill impairment loss allocated to multiple tax jurisdictions within a reporting unit?

Interpretive response: [Question 9.4.50](#) discusses how to allocate the impairment loss if a reporting unit has second component financial statement goodwill (nondeductible goodwill). If there is more than one separate tax-paying legal entity or tax jurisdiction within the reporting unit, the entity may need to further allocate the impairment to those lower levels.

The allocation processes discussed in this interpretive response should result in:

- none of the first component financial statement goodwill impairment being allocated to lower levels that, pre-impairment, have no first component financial statement goodwill; and
- none of the second component financial statement goodwill impairment being allocated to lower levels that, pre-impairment, have no second component financial statement goodwill.

Entity elects Method A

Under Method A outlined in [Question 9.4.60](#), the impairment loss is allocated to second component financial statement goodwill to the extent possible. See [Example 9.4.70](#) Scenario 3.

If the entire impairment loss is allocated to second component financial statement goodwill, one acceptable method of allocation would be a pro rata allocation of the impairment at the reporting unit level to those lower levels that, pre-impairment, have second component financial statement goodwill.

That allocation could be based on the proportion of pre-impairment second component financial statement goodwill at the jurisdictional/legal entity level to the total pre-impairment second component financial statement goodwill at the reporting unit level.

Entity elects Method B

Under Method B outlined in [Question 9.4.60](#), the impairment loss is allocated on a pro rata basis to the reporting unit's first component and second component financial statement goodwill. See [Example 9.4.70](#) Scenario 3.

An entity could apply the same principle discussed above for Method A as follows.

1. Determine how much impairment will be allocated to first and second component goodwill based on the pro rata calculation at the reporting unit level (i.e. apply Method B).
2. Determine each lower level's proportion of the reporting unit's total first and second components of goodwill.
3. Take the impairment loss attributed to each component at the reporting unit level (determined in (1)) and allocate it to the lower levels based on the proportions determined in (2).

4. Use the simultaneous equation to determine the adjustment to deferred taxes and the initial impairment loss allocated to first component goodwill.



Example 9.4.80

Allocating goodwill impairment to lower levels

Reporting Unit comprises two subsidiaries (Sub A and B) of ABC Corp. that are located in different tax-paying jurisdictions.

The following is the pre-impairment allocation of goodwill within Reporting Unit. The second component financial statement goodwill is nondeductible (see [Question 9.4.20](#)).

	Sub A	Sub B	Total RU
First component	\$100	\$50	\$150
Second component	200	–	200
Total goodwill	\$300	\$50	\$350

ABC is performing a goodwill impairment test for Reporting Unit and concludes that goodwill is impaired by \$100.

Scenario 1: ABC elects Method A

Under Method A (see [Question 9.4.60](#)), the impairment loss is allocated to second component financial statement goodwill to the extent possible. See [Example 9.4.70](#) Scenario 3.

ABC allocates the entire \$100 impairment loss to Sub A because only Sub A has second component financial statement goodwill; therefore, its proportionate share is 100%. There is no related income tax effect.

Scenario 2: ABC elects Method B

Under Method B (see [Question 9.4.60](#)), the impairment loss is allocated on a pro rata basis to the Reporting Unit's first component and second component financial statement goodwill. See [Example 9.4.70](#) Scenario 3.

Step 1. ABC determines how much of the initial impairment loss will be allocated to first and second component goodwill based on the pro rata calculation at Reporting Unit level.

	Total RU	Calculation	Allocation
First component	\$150	$\$100 \times (\$150 / \$350)$	\$ 43
Second component	200	$\$100 \times (\$200 / \$350)$	57
Total	\$350		\$100

Step 2. ABC determines Sub A's and Sub B's proportion of Reporting Unit's total first and second components of goodwill.

First component	Goodwill	Calculation	% share of RU
Sub A	\$100	$\$100 \div \150	67%
Sub B	50	$\$50 \div \150	33%
RU total	\$150		100%

Second component	Goodwill	Calculation	Allocation
Sub A	\$200	$\$200 \div \200	100%
Sub B	–	–	–
RU total	\$200		100%

Step 3. ABC multiplies the impairment attributed to each component at Reporting Unit level determined in Step 1 by the Sub A and Sub B proportions determined in Step 2.

Sub A	Goodwill before	Allocation	Goodwill after
First component	\$100	$\$43 \times 67\% = \29	\$ 71
Second component	200	$\$57 \times 100\% = \57	143
Total	\$300		\$214

Sub B	Goodwill before	Allocation	Goodwill after
First component	\$50	$\$43 \times 33\% = \14	\$36
Second component	–	–	–
Total	\$50		\$36

Step 4. ABC applies the simultaneous equation to determine the adjustment to deferred taxes and the initial impairment loss allocated to first component goodwill.

$$(\text{tax rate} \div (1 - \text{tax rate})) \times \text{initial impairment loss}$$

$$\text{Sub A: } (21\% \div (1 - 21\%)) \times \$29 = \$8$$

$$\text{Sub B: } (21\% \div (1 - 21\%)) \times \$14 = \$4$$

The following table shows the allocation of goodwill after recognition of the impairment loss.

	Sub A	Sub B	Total RU
First component	\$ 63 ¹	\$32 ²	\$ 95
Second component	143 ³	–	143
Total goodwill	\$206	\$32	\$238⁴

Notes:

- \$100 - \$29 (Step 3) - \$8 (Step 4).
- \$50 - \$14 (Step 3) - \$4 (Step 4).
- \$200 - \$57 (Step 3).
- \$350 - \$100 (Step 1) - \$12 (Step 4).

Note: Goodwill impairment and related deferred taxes in the separate financial statements of Sub A and Sub B may differ from the amounts above depending on how those subsidiaries identify their reporting units and their policies for intercorporate tax allocation.

9.4.30 Allocating impairment losses between parent and NCI



Excerpt from ASC 350-20

•• > Goodwill Impairment Testing and Disposal of All or a Portion of a Reporting Unit When the Reporting Unit is Less Than Wholly Owned

35-57A If a reporting unit is less than wholly owned, the fair value of the reporting unit as a whole shall be determined in accordance with paragraphs 350-20-35-22 through 35-24, including any portion attributed to the noncontrolling interest. Any impairment loss measured in the goodwill impairment test shall be attributed to the parent and the **noncontrolling interest** on a rational basis. If the reporting unit includes only goodwill attributable to the parent, the goodwill impairment loss would be attributed entirely to the parent. However, if the reporting unit includes goodwill attributable to both the parent and the noncontrolling interest, the goodwill impairment loss would be attributed to both the parent and the noncontrolling interest.

In a business combination, the acquirer recognizes 100% of the assets acquired and liabilities assumed even if its ownership interest is less than 100%. The acquirer also recognizes the full amount of goodwill – i.e. including the goodwill attributable to NCI. Consistent with that premise, an impairment loss on goodwill relates to the entire business – the parent and NCI. Therefore, the amount attributable to NCI is separately identified and included in both net income and comprehensive income attributable to NCI. [220-10-45-5]



Question 9.4.80

How is a goodwill impairment loss allocated between the parent and NCI?

Interpretive response: Subtopic 350-20 requires that an impairment loss be allocated between the parent and NCI on a 'rational basis' but does not specify any particular methods. [350-20-35-57A]

One method is to allocate an impairment loss on the same basis as the allocation of goodwill in the originating business combination. Often this will not be the same as the respective ownership interests of the parent and NCI because of any control premium paid in the acquisition.

However, additional consideration is required if any of the goodwill was recognized under legacy US GAAP, FASB Statement 141 (business combinations). Under the original version of that standard, no goodwill attributable to NCI was recognized.



Example 9.4.90

Goodwill impairment allocated to parent and NCI

Parent acquired an 80% controlling interest in Subsidiary some years ago and recognized goodwill of \$950, attributable as follows:

- Parent, \$800
- NCI, \$150

The goodwill was assigned to Reporting Unit, which was newly identified as a result of the acquisition.

Parent is performing a goodwill impairment test for Reporting Unit and concludes that goodwill is impaired by \$200. As a rational basis of allocation, Parent allocates the impairment loss between the parent and NCI in the same proportions as the original allocation of goodwill:

- Parent: $\$200 \times (\$800 \div \$950) = \168
- NCI: $\$200 \times (\$150 \div \$950) = \32

10. Disclosures

Detailed contents

10.1 How the standards work

10.2 All entities

Questions

- 10.2.10 Are the disclosures required only in the year that an impairment loss is recognized?
- 10.2.20 Is an entity required to disclose the method(s) used to measure fair value?
- 10.2.30 Are impairment-related fair value measurements 'recurring' or 'nonrecurring' under Topic 820?
- 10.2.40 At what level of the fair value hierarchy are impairment-related fair value measurements?
- 10.2.50 To what extent do the Topic 820 disclosures apply?
- 10.2.60 Is an entity expected to disclose the events or conditions that led to impairment?
- 10.2.70 Must an entity disclose potential future impairment losses?
- 10.2.80 Must an entity disclose a change in its annual goodwill impairment test date?

10.3 SEC registrants

Questions

- 10.3.10 What additional disclosures are expected of SEC registrants?
- 10.3.20 Do the disclosures apply to interim financial statements?
- 10.3.30 What are the SEC Form 8-K reporting responsibilities when a registrant incurs an impairment loss?

10.1 How the standards work

The disclosure requirements for the impairment of indefinite-lived intangibles, long-lived assets and goodwill are similar, and come from three main sources.

Topics 350 and 360	Topic 820	Topic 275
Similar disclosures for all impaired nonfinancial assets	Information about the fair value measurement that is the basis for the impairment loss	Disclosures about risks and uncertainties – e.g. potential future impairment
<p>Examples:</p> <ul style="list-style-type: none"> — Amount of impairment loss — Description of impaired asset — Facts and circumstances that led to impairment 	<p>Examples:</p> <ul style="list-style-type: none"> — Description of valuation technique(s) and inputs used — Changes to technique(s) and reasons therefor 	<p>Disclose if:</p> <ul style="list-style-type: none"> — reasonably possible of occurring; — would occur in the near term; and — effect would be material to the financial statements

In addition, SEC registrants are expected to make more granular disclosures in MD&A. Examples of these disclosures include the following.

- **Critical accounting estimates** – e.g. the difference between the sum of the estimated fair value of multiple reporting units and the registrant’s market capitalization.
- **Cash flow projections** – e.g. whether cash flow projections indicate that the registrant is likely to violate debt covenants in the future.
- **Potential future impairment losses** – e.g. if the fair value of a reporting unit as of the date of the last impairment test is not substantially in excess of the carrying amount, the percentage by which fair value exceeds its carrying amount.

This chapter refers to the following throughout:

- an indefinite-lived intangible asset, although the unit of account might be a grouping of such assets (see [section 3.2](#)); and
- an asset group, although the unit of account might be a single asset (see [section 3.3](#)).

10.2 All entities



Excerpt from ASC 350-20

45-1 The aggregate amount of **goodwill** shall be presented as a separate line item in the statement of financial position.

45-2 The aggregate amount of goodwill impairment losses shall be presented as a separate line item in the income statement before the subtotal income from continuing operations (or similar caption) unless a goodwill impairment loss is associated with a discontinued operation.

45-3 A goodwill impairment loss associated with a discontinued operation shall be included (on a net-of-tax basis) within the results of discontinued operations. For guidance on reporting discontinued operations, see Subtopic 205-20.

> Information for Each Period for Which a Statement of Financial Position is Presented

50-1 The changes in the carrying amount of goodwill during the period shall be disclosed, showing separately (see Example 3 [paragraph 350-20-55-24]):

- a. The gross amount and accumulated impairment losses at the beginning of the period
- ...
- e. Impairment losses recognized during the period in accordance with this Subtopic
- ...
- h. The gross amount and accumulated impairment losses at the end of the period.

Entities that report segment information in accordance with Topic 280 shall provide the above information about goodwill in total and for each reportable segment and shall disclose any significant changes in the allocation of goodwill by reportable segment. If any portion of goodwill has not yet been allocated to a reporting unit at the date the financial statements are issued, that unallocated amount and the reasons for not allocating that amount shall be disclosed

50-1A Entities that have one or more reporting units with zero or negative carrying amounts of net assets shall disclose those reporting units with allocated goodwill and the amount of goodwill allocated to each and in which reportable segment the reporting unit is included.

> Goodwill Impairment Loss

50-2 For each goodwill impairment loss recognized, all of the following information shall be disclosed in the notes to the financial statements that include the period in which the impairment loss is recognized:

- a. A description of the facts and circumstances leading to the impairment
- b. The amount of the impairment loss and the method of determining the fair value of the associated reporting unit (whether based on quoted market

prices, prices of comparable businesses or nonprofit activities, a present value or other valuation technique, or a combination thereof).

50-3 The quantitative disclosures about significant unobservable inputs used in fair value measurements categorized within Level 3 of the fair value hierarchy required by paragraph 820-10-50-2(bbb) are not required for fair value measurements related to the financial accounting and reporting for goodwill after its initial recognition in a business combination.

> Implementation Guidance

• > Example 3: Illustration of Disclosures

55-24 In accordance with paragraphs 350-20-50-1 through 50-2, the following disclosures would be made by Theta Entity in its December 31, 20X3 financial statements relating to goodwill.

Theta Entity has three reporting units with goodwill—Software, Electronics, and Communications—and two reportable segments—Technology and Communications. The Electronics reporting unit has a negative carrying amount.

Note C: Goodwill

The changes in the carrying amount of goodwill for the year ended December 31, 20X3, are as follows.

(000s)	Technology Segment	Communications Segment	Total
Balance as of January 1, 20X3			
Goodwill	\$ 1,413	\$ 1,104	\$ 2,517
Accumulated impairment losses	-	(200)	(200)
	<u>1,413</u>	<u>904</u>	<u>2,317</u>
Goodwill acquired during year	189	115	304
Impairment losses	-	(46)	(46)
Goodwill written off related to sale of business unit	(484)	-	(484)
Balance as of December 31, 20X3			
Goodwill	1,118	1,219	2,337
Accumulated impairment losses	-	(246)	(246)
	<u>\$ 1,118</u>	<u>\$ 973</u>	<u>\$ 2,091</u>

The Communications segment is tested for impairment in the third quarter, after the annual forecasting process. Due to an increase in competition in the Texas and Louisiana cable industry, operating profits and cash flows were lower than expected in the fourth quarter of 20X2 and the first and second quarters of 20X3. Based on that trend, the earnings forecast for the next five years was revised. In September 20X3, a goodwill impairment loss of \$46 was recognized in the Communications reporting unit. The fair value of that reporting unit was estimated using the expected present value of future cash flows.

The Electronics reporting unit to which \$498 of goodwill is allocated had a negative carrying amount on December 31, 20X3, and 20X2. This reporting unit is part of the Technology segment.



Excerpt from ASC 350-20

Accounting Alternatives

50-3B An entity within the scope of paragraph 350-20-15-4A that elects the accounting alternative for a goodwill impairment triggering event evaluation shall disclose its use of the alternative as a significant accounting policy in accordance with paragraph 235-10-50-1.



Excerpt from ASC 350-30

> Disclosures Relating to Impairment Losses

50-3 For each impairment loss recognized related to an intangible asset, all of the following information shall be disclosed in the notes to financial statements that include the period in which the impairment loss is recognized:

- a. A description of the impaired intangible asset and the facts and circumstances leading to the impairment
- b. The amount of the impairment loss and the method for determining fair value
- c. The caption in the income statement or the statement of activities in which the impairment loss is aggregated
- d. If applicable, the segment in which the impaired intangible asset is reported under Topic 280.

50-3A A **nonpublic entity** is not required to disclose the quantitative information about significant unobservable inputs used in fair value measurements-10-55-2(b) categorized within Level 3 of the fair value hierarchy required by paragraph 820bb) that relate to the financial accounting and reporting for an indefinite-lived intangible asset after its initial recognition.



Excerpt from ASC 360-10

> Impairment of Long-Lived Assets Classified as Held and Used

50-2 All of the following information shall be disclosed in the notes to financial statements that include the period in which an **impairment** loss is recognized:

- a. A description of the impaired long-lived asset (asset group) and the facts and circumstances leading to the impairment
- b. If not separately presented on the face of the statement, the amount of the impairment loss and the caption in the income statement or the statement of activities that includes that loss
- c. The method or methods for determining fair value (whether based on a quoted market price, prices for similar assets, or another valuation technique)

- d. If applicable, the segment in which the impaired long-lived asset (asset group) is reported under Topic 280.



Excerpt from ASC 820-10

50-2 A reporting entity shall disclose the following information for each class of assets and liabilities (see paragraph 820-10-50-2B for information on determining appropriate classes of assets and liabilities) measured at fair value (including measurements based on fair value within the scope of this Topic) in the statement of financial position after initial recognition:

- a. For recurring fair value measurements, the fair value measurement at the end of the reporting period, and for nonrecurring fair value measurements, the fair value measurement at the relevant measurement date and the reasons for the measurement. Recurring fair value measurements of assets or liabilities are those that other Topics require or permit in the statement of financial position at the end of each reporting period. Nonrecurring fair value measurements of assets or liabilities are those that other Topics require or permit in the statement of financial position in particular circumstances (for example, when a reporting entity measures a long-lived asset or disposal group classified as held for sale at fair value less costs to sell in accordance with Topic 360 because the asset's fair value less costs to sell is lower than its carrying amount). For nonrecurring measurements estimated at a date during the reporting period other than the end of the reporting period, a reporting entity shall clearly indicate that the fair value information presented is not as of the period's end as well as the date or period that the measurement was taken.
- b. For recurring and nonrecurring fair value measurements, the level of the fair value hierarchy within which the fair value measurements are categorized in their entirety (Level 1, 2, or 3).
- bbb. The information shall include:
 1. For recurring and nonrecurring fair value measurements categorized within Level 2 and Level 3 of the fair value hierarchy, a description of the valuation technique(s) and the inputs used in the fair value measurement. If there has been a change in either or both a valuation approach and a valuation technique (for example, changing from matrix pricing to the binomial model or the use of an additional valuation technique), the reporting entity shall disclose that change and the reason(s) for making it.
 2. For fair value measurements categorized within Level 3 of the fair value hierarchy, a reporting entity shall provide quantitative information about the significant unobservable inputs used in the fair value measurement. A reporting entity is not required to create quantitative information to comply with this disclosure requirement if quantitative unobservable inputs are not developed by the reporting entity when measuring fair value (for example, when a reporting entity uses prices from prior transactions or third-party pricing information without adjustment). However, when providing this disclosure, a reporting entity cannot

ignore quantitative **unobservable inputs** that are significant to the fair value measurement and are reasonably available to the reporting entity. Employee benefit plans, other than those plans that are subject to the U.S. Securities and Exchange Commission's (SEC) filing requirements, are not required to provide this disclosure for investments held by an employee benefit plan in their plan sponsor's own nonpublic equity securities, including equity securities of their plan sponsor's nonpublic affiliated entities.

- i. In complying with (bbb)(2), a reporting entity shall provide the range and weighted average of significant unobservable inputs used to develop Level 3 fair value measurements. A reporting entity shall disclose how it calculated the weighted average (for example, weighted by relative fair value). For certain unobservable inputs, a reporting entity may disclose other quantitative information, such as the median or arithmetic average, in lieu of the weighted average, if such information would be a more reasonable and rational method to reflect the distribution of unobservable inputs used to develop the Level 3 fair value measurement. An entity does not need to disclose its reason for omitting the weighted average in these cases.
- ii. A nonpublic entity is not required to provide the information described in (bbb)(2)(i), but is required to provide quantitative information about the significant unobservable inputs used in the fair value measurement in accordance with (bbb)(2).

...

- h. For recurring and nonrecurring fair value measurements, if the **highest and best use** of a nonfinancial asset differs from its current use, a reporting entity shall disclose that fact and why the nonfinancial asset is being used in a manner that differs from its highest and best use.

The requirements for disclosing an impairment loss for indefinite-lived intangible assets, long-lived assets and goodwill are similar. The common disclosures required by Topics 350 and 360 are: [\[350-20-50-2, 350-30-50-3, 360-10-50-2\]](#)

- a description of the impaired asset (if not goodwill);
- the facts and circumstances leading to the impairment;
- the amount of the impairment loss;
- the method(s) of measuring fair value; and
- the segment in which the impaired asset is reported (if applicable).

Additional disclosures required by Topic 820 (fair value measurement) go beyond identifying the method(s) used to measure fair value.



Question 10.2.10

Are the disclosures required only in the year that an impairment loss is recognized?

Interpretive response: No. The impairment disclosures need to remain in the financial statement notes as long as the financial statements include the

impairment loss in one of the periods presented. Further, an entity is required to disclose the amount of accumulated goodwill impairment losses at the beginning and end of each period for which a balance sheet is presented. [350-20-50-1 – 50-3, 350-30-50-3, 360-10-50-2]

For example, if an SEC registrant presents two balance sheets and three income statements, statements of cash flows and statements of shareholders' equity, the impairment disclosures remain in the notes to the financial statements for three years. Additionally, the registrant discloses the amount of accumulated goodwill impairment losses at the beginning and end of each of the most recent two years.



Question 10.2.20

Is an entity required to disclose the method(s) used to measure fair value?

Interpretive response: Yes. This is a specific requirement of Subtopics 350-20 and 350-30, and Topic 360 – in addition to the requirements of Topic 820 (see [Question 10.2.50](#)). For reporting units and asset groups, an entity is also required to disclose whether the method of measuring fair value was based on a quoted market price, prices for comparable businesses or nonprofit activities (or similar assets), another valuation technique, or a combination thereof. [350-20-50-2(b), 350-30-50-3(b), 360-10-50-2(c)]

An entity meets this disclosure requirement by disclosing the method(s) used to determine fair value – e.g. quoted market price or discounted cash flows under the income approach.



Question 10.2.30

Are impairment-related fair value measurements 'recurring' or 'nonrecurring' under Topic 820?

Interpretive response: Impairment-related fair value measurements are 'nonrecurring' under Topic 820.

Recurring fair value measurements arise from assets and liabilities measured at fair value at the end of each reporting period (e.g. trading securities).

Nonrecurring fair value measurements are fair value measurements triggered by circumstances that may occur during the reporting period (e.g. an impaired nonfinancial asset resulting in the need for fair value measurement). [820-10-50-2(a)]

This distinction is important because it drives the level of fair value disclosures required. The disclosures required for a nonrecurring fair value measurement apply in the financial statements for the period in which the fair value measurement occurred.



Question 10.2.40

At what level of the fair value hierarchy are impairment-related fair value measurements?

Background: The fair value hierarchy is made up of three levels. Fair value measurements are categorized in their entirety based on the lowest level input that is significant to the entire measurement. [820-10-35-37 – 35-37A, 820-10 Glossary]

- Level 1 inputs: Unadjusted quoted prices in active markets for identical assets or liabilities that the entity can access at the measurement date.
- Level 2 inputs: Inputs other than quoted prices included within Level 1 that are observable for the asset or liability, either directly (i.e. as prices) or indirectly (i.e. derived from prices).
- Level 3 inputs: Unobservable inputs for the asset or liability.

Interpretive response: Impairment-related fair value measurements are usually classified as Level 3 because they use significant unobservable inputs (see [chapter 8](#)). This classification is important because it drives the level of fair value disclosures required.



Question 10.2.50

To what extent do the Topic 820 disclosures apply?

Interpretive response: Absent any exemptions, the Topic 820 disclosures for nonrecurring fair value measurements apply to the fair value measurements that were the basis for an impairment loss related to goodwill, long-lived assets or an indefinite-lived intangible asset.

However, there are two exemptions from the requirement to disclose *quantitative* information about significant unobservable inputs used in fair value measurements categorized within Level 3 of the fair value hierarchy (paragraph 820-10-50-2(bbb)).

- For nonpublic entities, disclosures related to the impairment of indefinite-lived intangible assets. [350-30-50-3A]
- For all entities, disclosures related to the impairment of goodwill. [350-20-50-3]

There is no exemption related to the impairment of long-lived assets.

Taking into account the exemptions, the following table summarizes the Topic 820 disclosures that apply to impairments.

	Indefinite-lived intangibles	Long-lived assets	Goodwill
Fair value and, if applicable, statement that it was not as of the reporting date [820-10-50-2(a)]	✓	✓	✓
Reasons for the measurement [820-10-50-2(a)]	✓	✓	✓
Level within hierarchy [820-10-50-2(b)]	✓	✓	✓
Description of valuation technique and inputs used [820-10-50-2(bbb)(1)]	✓	✓	✓
Changes to valuation approaches and/or techniques, and reasons therefor [820-10-50-2(bbb)(1)]	✓	✓	✓
Quantitative information about significant unobservable inputs [820-10-50-2(bbb)(2)]	P	✓	✗
For nonfinancial assets when highest and best use differs from actual, the reasons why [820-10-50-2(h)]	✓	✓	✓
Legend ✗ Disclosure not required ✓ Disclosure required for all entities P Disclosure required for public business entities only			



Question 10.2.60

Is an entity expected to disclose the events or conditions that led to impairment?

Interpretive response: Yes. This requirement applies regardless of whether the impairment loss was the result of an entity's annual impairment test (see [section 4.2](#)) or an interim triggering event that led to an impairment test (see [section 4.3](#)). [350-20-50-2, 350-30-50-3, 360-10-50-2]



Question 10.2.70

Must an entity disclose potential future impairment losses?

Interpretive response: Generally, yes. An entity is required to disclose those events or changes in circumstances that could affect significantly the amounts reported in the financial statements. Disclosure is required if: [\[275-10-50-8\]](#)

- these events or circumstances are ‘reasonably possible’ of occurring (i.e. more than remote);
- these events or circumstances would occur in the ‘near term’ due to one or more future confirming events; and
- the effect of these events or circumstances would be material to the financial statements.



Question 10.2.80

Must an entity disclose a change in its annual goodwill impairment test date?

Interpretive response: Yes. A change in a reporting unit’s annual goodwill impairment testing date is a change in the method of applying an accounting principle. Therefore, the disclosure requirements of Topic 250 apply, including the nature of and reason for the change in accounting principle, and an explanation of why the new testing date is preferable. [\[250-10-50-1\]](#)

Further, the SEC requires the change in testing date to be ‘prominently disclosed’ to avoid a preferability letter (see [Question 4.2.40](#)).

10.3 SEC registrants



Question 10.3.10

What additional disclosures are expected of SEC registrants?

Interpretive response:

Critical accounting estimates

Transparent and robust disclosures are appropriate in the critical accounting estimates section of MD&A regarding the goodwill impairment valuation techniques and critical assumptions used. These include:

- how reporting units are determined;
- the methodology and assumptions used to determine the fair value of reporting units;
- the valuation method or method(s) used;

- if multiple valuation methods are used, the weighting applied to different methods and reason(s) for doing so; and
- key assumptions and sensitivity analyses.

Further, a registrant should provide an explanation in MD&A of the difference between the sum of the estimated fair value of multiple reporting units and its market capitalization, including information about:

- how the control premium (market participant acquisition premium) is determined; and
- the measurement date (or range of dates used) for market prices.

These disclosures are expected to be provided each reporting period with an explanation of any changes from prior periods.

Further, an entity should disclose changes in its asset groups, whether due to changes in facts and circumstances or if it develops plans to dispose of a group of assets (see [Questions 3.3.120](#) and [3.3.140](#)).

Cash flow projections

In addition to disclosing the method(s) for determining the fair value of an asset group, the SEC staff has required SEC registrants to disclose the key assumptions used to develop cash flow projections. [\[360-10-S99-2\]](#)

The staff has also required a discussion in MD&A of the implications of those assumptions. A registrant should consider the following, for example: [\[360-10-S99-2\]](#)

- whether the projections indicate that it is likely to violate debt covenants in the future;
- whether it has informed the market and shareholders of its lower expectations for the future that are sufficient to cause an impairment loss; and
- if growth rates used in the impairment analysis are lower than those used by outside analysts, whether the registrant has discussed with the analysts their overly optimistic projections.

The SEC staff expects these disclosures to be provided each reporting period (to the extent relevant) with an explanation of any changes from prior periods.

Implications of an impairment loss

In addition to disclosing the events or conditions that led to the current period impairment loss, the SEC staff expects registrants to disclose how those events or conditions might alter future expectations of earnings and cash flows related to the business. The SEC staff will often ask for more disclosures about what the conditions that resulted in impairments mean to the registrant's business, as well as for more forward-looking information about the risk of future impairments. In other words, impairment disclosures should focus not only on the noncash nature of a recognized impairment loss but should also address the business and economic conditions that gave rise to the loss.

For example, a goodwill impairment loss may indicate that an SEC registrant overpaid for a business, prompting disclosure in MD&A of the adverse events that have occurred since the acquisition.

Potential impairment losses

Disclosure of the potential for material impairment loss is generally expected each reporting period with an explanation of any changes from prior periods, and in advance of any impairment charge. [\[S-K Item 303\(a\)\(3\)\(iii\)\]](#)

For example, if a registrant has a reporting unit that is at risk of failing the goodwill impairment test, and an impairment of goodwill allocated to that reporting unit could be material, the SEC staff would expect that registrant to highlight the risk of impairment in its financial statements. [\[2009 AICPA Conf\]](#)

Further, if the fair value of a reporting unit as of the date of the last impairment test is not substantially in excess of the carrying amount, the SEC staff expects a registrant to disclose: [\[2009 AICPA Conf\]](#)

- the percentage by which the fair value of the reporting unit exceeds its carrying amount;
- the amount of goodwill allocated to the reporting unit;
- a discussion of the assumptions used and any uncertainty inherent in those assumptions; and
- a discussion of the potential events and circumstances that could have a negative effect on the assumptions.

The SEC staff has no bright lines and judgment should be applied to determine whether the fair value of a reporting unit is substantially in excess of its carrying amount. A registrant should consider the level of uncertainty inherent in its assumptions, external factors affecting its industry or market, and any other data that may affect its estimate of fair value. [\[2009 AICPA Conf\]](#)

If the fair value of a reporting unit is not substantially in excess of its carrying amount, the SEC staff believes that the risk of an impairment has risen to the level of a known uncertainty. Therefore, the registrant would need to comply with the disclosure requirements related to known uncertainties.



Question 10.3.20

Do the disclosures apply to interim financial statements?

Interpretive response: Neither Topic 350 nor Topic 360 explicitly address whether the impairment loss disclosures apply to interim financial statements in addition to annual financial statements. These disclosures should generally be provided in interim periods that include a material impairment loss. [\[270-10-45-11A\]](#)

Further, the SEC requires registrants to disclose in an interim period new accounting principles and practices that have changed significantly in amount or composition, and other significant changes that have occurred since the end of the most recently completed fiscal year. [\[S-X Rule 10-01\(a\)\(5\)\]](#)



Question 10.3.30

What are the SEC Form 8-K reporting responsibilities when a registrant incurs an impairment loss?

Interpretive response: A material impairment loss triggers a Form 8-K filing requirement.

When a Form 8-K is required

A Form 8-K is required to be filed when a registrant's board of directors (or a committee of the board, or an authorized officer(s) if board action is not required) concludes that a material impairment loss for one or more assets is required at the next financial statement reporting date.

Form 8-K broadly defines the scope of the asset impairments it covers, stating it is required whenever "a material charge for impairment to one or more assets, including, without limitation, an impairment of securities and goodwill, is required under generally accepted accounting principles." [\[Form 8-K Item 2.06\]](#)

However, if a material impairment loss is identified in conjunction with a quarter- or year-end closing process, the information that would otherwise be included in a Form 8-K may instead be included in the registrant's next periodic report – e.g. filing on Form 10-Q under Item 5 of Part II. A registrant should consult with securities counsel when it expects to incur a material impairment loss to determine its filing responsibilities. [\[Form 8-K Item 2.06\]](#)

Required disclosures

The following disclosures are required in Form 8-K: [\[Form 8-K Item 2.06\]](#)

- the date of the conclusion that recognition of a material loss is required, a description of the impaired asset(s), and the facts and circumstances leading to the impairment loss;
- an estimate of the amount or range of amounts of the impairment loss; and
- an estimate of the amount or range of amounts of the impairment loss that will result in future cash expenditures.

Timing of filing

A registrant has four business days following the date on which a conclusion is reached to file the Form 8-K that includes the above disclosures. This means a registrant has four days to formulate an amount or range of amounts of an impairment loss.

11. Goodwill amortization accounting alternative

Detailed contents

- 11.1 How the standard works**
- 11.2 Scope**
- 11.3 Goodwill amortization**
- 11.4 Goodwill impairment testing**
- 11.5 Allocating amortization and impairment to the components of goodwill**
 - Example**
 - 11.5.10 Goodwill amortization – tax accounting
- 11.6 Allocating goodwill to disposals**
- 11.7 Presentation and disclosure**
- 11.8 Moving in and out of the amortization accounting alternative**
 - 11.8.10 Adopting the accounting alternative
 - 11.8.20 Ceasing to apply the accounting alternative
 - Example**
 - 11.8.10 Valuation allowance on adoption of accounting alternative

11.1 How the standard works

The goodwill amortization accounting alternative for private companies and NFPs is a simplified way of accounting for goodwill.

Eligible entities	<ul style="list-style-type: none"> — Private companies – i.e. entities that are not public business entities or employee benefit plans — Not-for-profit entities
Scope	<ul style="list-style-type: none"> — Goodwill recognized in a business combination — Equity-method goodwill (not in the scope of this publication) — Excess reorganization value
Accounting	<ul style="list-style-type: none"> — Amortize goodwill over a period of up to 10 years — Test goodwill for impairment only when a triggering event occurs
Adoption	<ul style="list-style-type: none"> — Accounting alternative may be elected at any time — Applies prospectively

This chapter discusses the accounting alternative for amortization of goodwill. The related accounting alternative on identifiable intangible assets is discussed in section 26 of KPMG Handbook, [Business combinations](#).

The accounting alternative for a goodwill impairment triggering event evaluation, which is discussed in [section 4.3.40](#), is available regardless of whether a private company or NFP elects the amortization accounting alternative discussed in this chapter.

11.2 Scope



Excerpt from ASC 350-20

15-3A Paragraphs 350-20-15-4 through 15-6, 350-20-35-62 through 35-86, 350-20-40-8 through 40-9, 350-20-45-4 through 45-7, 350-20-50-3A through 50-7, 350-20-55-26 through 55-29, and 323-10-35-13 provide guidance for an entity electing the accounting alternatives in this Subtopic. See paragraphs 350-20-65-2 and 350-20-65-4 for transition guidance for private companies and not-for-profit entities on applying the accounting alternatives in Subtopic 350-20.

Accounting Alternatives

15-4 A **private company** or **not-for-profit entity** may make an accounting policy election to apply the accounting alternative for amortizing goodwill in this Subtopic to the following transactions or activities:

- a. **Goodwill** that an entity recognizes in a business combination in accordance with Subtopic 805-30 or in an **acquisition by a not-for-profit entity** in accordance with Subtopic 958-805 after it has been initially recognized and measured
- b. Amounts recognized as goodwill in applying the equity method of accounting in accordance with Topic 323 on investments—equity method and joint ventures, and to the excess reorganization value recognized by entities that adopt fresh-start reporting in accordance with Topic 852 on reorganizations.

15-4A A private company or not-for-profit entity may make an accounting policy election to apply the accounting alternative for a goodwill impairment triggering event evaluation to goodwill subsequently accounted for in accordance with Subtopic 350-20.

15-5 An entity within the scope of the paragraph 350-20-15-4 or paragraph 350-20-15-4A that elects the accounting alternative for amortizing goodwill or the accounting alternative for goodwill impairment triggering event evaluation shall apply all of the related subsequent measurement, derecognition, other presentation matters, and disclosure requirements upon election. An accounting alternative, once elected, shall be applied to existing goodwill and to all additions to goodwill recognized in future transactions within the scope of that accounting alternative.

15-6 An entity that elects either of the accounting alternatives in this Subtopic is not required to elect or precluded from electing the other alternative.

The Accounting Alternatives Subsections of Subtopic 350-20 allow private companies and NFPs to amortize goodwill after it is initially recognized. Goodwill includes the goodwill recognized in a business combination, equity-method goodwill and excess reorganization value.

Before applying this accounting alternative, an entity should evaluate if it is a public business entity that cannot apply those alternatives. For example, entities meet the definition of a public business entity if their financial statements are included in a registrant's SEC filing, such as when the entity is a significant

acquiree under Rule 3-05 of Regulation S-X, a significant equity method investee under Rule 3-09 of Regulation S-X, or an equity method investee whose summarized financial information is included in a registrant's SEC filing under Rule 4-08(g) of Regulation S-X.

If an entity is considered a public business entity due only to the inclusion of its financial statements within another entity's SEC filing, the entity is considered a public business entity only for the SEC filing. For its stand-alone financial statements used for other purposes, the accounting alternatives can be elected. However, the definition of public business entity is different from the definition used for public entities for pro forma disclosures and a careful evaluation is required.

Management of a private company should carefully consider whether it might take the company public in the future before adopting the goodwill amortization alternative. For example, an entity that is a private company now that becomes a public business entity in the future – e.g. because its financial statements will be included in an SEC filing by another entity, or it is itself filing a registration statement with the SEC. In that case, it will need to recast historical financial statements to comply with the requirements applicable to a public business entity – i.e. as if the accounting alternatives had not been elected.

11.3 Goodwill amortization



Excerpt from ASC 350-20

> Accounting Alternative for Amortizing Goodwill

35-62 The following guidance for **goodwill** applies to entities within the scope of paragraph 350-20-15-4 that elect the accounting alternative for amortizing goodwill.

- > Amortization of Goodwill

35-63 Goodwill relating to each **business combination, acquisition by a not-for-profit entity**, or reorganization event resulting in fresh-start reporting (amortizable unit of goodwill) shall be amortized on a straight-line basis over 10 years, or less than 10 years if the entity demonstrates that another useful life is more appropriate.

35-64 An entity may revise the remaining useful life of goodwill upon the occurrence of events and changes in circumstances that warrant a revision to the remaining period of amortization. However, the cumulative amortization period for any amortizable unit of goodwill cannot exceed 10 years. If the estimate of the remaining useful life of goodwill is revised, the remaining carrying amount of goodwill shall be amortized prospectively on a straight-line basis over that revised remaining useful life.

A private company or NFP that elects the accounting alternative amortizes goodwill on a straight-line basis over ten years, or less than ten years if it can demonstrate that a shorter useful life is more appropriate. An entity is not

required to justify a 10-year amortization period for goodwill, even if the primary asset(s) acquired in the transaction is expected to generate cash flows for a period of less than 10 years.

An entity may be able to demonstrate that a shorter amortization period is appropriate if the economic benefits expected to be derived from the primary asset(s) is also shorter than 10 years. For example, it may be able to demonstrate a shorter life if goodwill consists of significant customer-related intangibles and/or noncompete agreements for which the alternative for those assets has been applied (see KPMG Handbook, [Business combinations](#)) or perhaps when goodwill is primarily attributable to workforce in place. However, entities are neither required to identify an amortization period shorter than 10 years nor permitted to use an amortization period longer than 10 years.

11.4 Goodwill impairment testing



Excerpt from ASC 350-20

- > Recognition and Measurement of a Goodwill Impairment Loss

35-65 Upon adoption of this accounting alternative, an entity shall make an accounting policy election to test goodwill for impairment at the entity level or the **reporting unit** level. An entity that elects to perform its impairment tests at the reporting unit level shall refer to paragraphs 350-20-35-33 through 35-38 and paragraphs 350-20-55-1 through 55-9 to determine the reporting units of an entity.

- • > When to Test Goodwill for Impairment

35-66 Goodwill of an entity (or a reporting unit) shall be tested for impairment if an event occurs or circumstances change that indicate that the fair value of the entity (or the reporting unit) may be below its carrying amount (a triggering event). Paragraph 350-20-35-3C(a) through (g) includes examples of those events or circumstances. Those examples are not all-inclusive, and an entity shall consider other relevant events and circumstances that affect the fair value or carrying amount of the entity (or of a reporting unit) in determining whether to perform the goodwill impairment test. For those entities that have elected the accounting alternative for a goodwill impairment triggering event evaluation in paragraph 350-20-35-84, a goodwill triggering event evaluation shall be performed only as of the end of each reporting period. If an entity determines that there are no triggering events, then further testing is unnecessary.

- • > The Goodwill Impairment Test

35-67 Upon the occurrence of a triggering event, an entity may assess qualitative factors to determine whether it is more likely than not (that is, a likelihood of more than 50 percent) that the fair value of the entity (or the reporting unit) is less than its carrying amount, including goodwill. Paragraph 350-20-35-3C(a) through (g) includes examples of those qualitative factors.

35-68 Because the examples included in paragraph 350-20-35-3C(a) through (g) are not all-inclusive, an entity shall consider other relevant events and

circumstances that affect the fair value or carrying amount of the entity (or of the reporting unit) in determining whether to perform the quantitative goodwill impairment test. An entity shall consider the extent to which each of the adverse events and circumstances identified could affect the comparison of its fair value with its carrying amount (or of the reporting unit's fair value with the reporting unit's carrying amount). An entity should place more weight on the events and circumstances that most affect its fair value or the carrying amount of its net assets (or the reporting unit's fair value or the carrying amount of the reporting unit's net assets). An entity also should consider positive and mitigating events and circumstances that may affect its determination of whether it is more likely than not that its fair value is less than its carrying amount (or the fair value of the reporting unit is less than the carrying amount of the reporting unit). If an entity has a recent fair value calculation (or recent fair value calculation for the reporting unit), it also should include that calculation as a factor in its consideration of the difference between the fair value and the carrying amount in reaching its conclusion about whether to perform the quantitative goodwill impairment test.

35-69 An entity shall evaluate, on the basis of the weight of evidence, the significance of all identified events and circumstances in the context of determining whether it is more likely than not that the fair value of the entity (or the reporting unit) is less than its carrying amount. None of the individual examples of events and circumstances included in paragraph 350-20-35-3C(a) through (g) are intended to represent standalone events or circumstances that necessarily require an entity to perform the quantitative goodwill impairment test. Also, the existence of positive and mitigating events and circumstances is not intended to represent a rebuttable presumption that an entity should not perform the quantitative goodwill impairment test.

35-70 An entity has an unconditional option to bypass the qualitative assessment described in paragraphs 350-20-35-67 through 35-69 and proceed directly to a quantitative calculation by comparing the entity's (or the reporting unit's) fair value with its carrying amount (see paragraphs 350-20-35-72 through 35-78). An entity may resume performing the qualitative assessment upon the occurrence of any subsequent triggering events.

35-71 If, after assessing the totality of events or circumstances such as those described in paragraph 350-20-35-3C(a) through (g), an entity determines that it is not more likely than not that the fair value of the entity (or the reporting unit) is less than its carrying amount, further testing is unnecessary.

35-72 If, after assessing the totality of events or circumstances such as those described in paragraph 350-20-35-3C(a) through (g), an entity determines that it is more likely than not that the fair value of the entity (or the reporting unit) is less than its carrying amount or if the entity elected to bypass the qualitative assessment in paragraphs 350-20-35-67 through 35-69, the entity shall determine the fair value of the entity (or the reporting unit) and compare the fair value of the entity (or the reporting unit) with its carrying amount, including goodwill. A goodwill impairment loss shall be recognized if the carrying amount of the entity (or the reporting unit) exceeds its fair value.

35-73 A goodwill impairment loss, if any, shall be measured as the amount by which the carrying amount of an entity (or a reporting unit) including goodwill exceeds its fair value, limited to the total amount of goodwill of the entity (or

allocated to the reporting unit). Additionally, an entity shall consider the income tax effect from any tax deductible goodwill on the carrying amount of the entity (or the reporting unit), if applicable, in accordance with paragraph 350-20-35-8B when measuring the goodwill impairment loss. See Example 2A in paragraph 350-20-55-23A for an illustration.

35-74 The guidance in paragraphs 350-20-35-22 through 35-27 shall be considered in determining the fair value of the entity (or the reporting unit).

35-76 For an entity subject to the requirements of Topic 740 on income taxes, when determining the carrying amount of an entity (or a reporting unit), deferred income taxes shall be included in the carrying amount of an entity (or the reporting unit), regardless of whether the fair value of the entity (or the reporting unit) will be determined assuming it would be bought or sold in a taxable or nontaxable transaction.

35-77 The goodwill impairment loss, if any, shall be allocated to individual amortizable units of goodwill of the entity (or the reporting unit) on a pro rata basis using their relative carrying amounts or using another reasonable and rational basis.

35-78 After a goodwill impairment loss is recognized, the adjusted carrying amount of goodwill shall be its new accounting basis, which shall be amortized over the remaining useful life of goodwill. Subsequent reversal of a previously recognized goodwill impairment loss is prohibited.

• • > Interaction of the Impairment Tests for Goodwill and Other Assets (or Asset Groups)

35-79 If goodwill and another asset (or asset group) of the entity (or the reporting unit) are tested for impairment at the same time, the other asset (or asset group) shall be tested for impairment before goodwill. For example, if a significant asset group is to be tested for impairment under the Impairment or Disposal of Long-Lived Assets Subsections of Subtopic 360-10 on property, plant, and equipment (thus potentially requiring a goodwill impairment test), the impairment test for the significant asset group would be performed before the goodwill impairment test. If the asset group is impaired, the impairment loss would be recognized prior to goodwill being tested for impairment.

35-80 The requirement in the preceding paragraph applies to all assets that are tested for impairment, not just those included in the scope of the Impairment or Disposal of Long-Lived Assets Subsections of Subtopic 360-10.

• > Equity Method Investments

35-81 The portion of the difference between the cost of an investment and the amount of underlying equity in net assets of an equity method investee that is recognized as goodwill in accordance with paragraph 323-10-35-13 (equity method goodwill) shall be amortized on a straight-line basis over 10 years, or less than 10 years if the entity demonstrates that another useful life is more appropriate.

An entity applying the goodwill accounting alternative is permitted to continue to test goodwill for impairment at the reporting unit level (see [section 3.4](#)) or can test impairment prospectively at the entity level. An entity that makes a

policy election to test goodwill for impairment at the entity level does not need to demonstrate this policy election is preferable. [350-20-35-65]

When a triggering event is identified, entities have an option to first perform a qualitative assessment to determine whether a quantitative impairment test is necessary. This guidance is consistent with the qualitative assessment guidance for entities that are not applying the alternative (see [chapter 6](#)). [350-20-35-67]

Private companies and NFPs may elect to apply an accounting alternative for a goodwill impairment triggering event evaluation. This relief, which is discussed in [section 4.3.40](#), is available regardless of whether a private company or NFP elects the accounting alternative discussed in this chapter.

If the qualitative assessment indicates that it is more likely than not that goodwill is impaired, entities must perform a quantitative test that compares the fair value of the entity (or reporting unit) with its carrying amount. [350-20-35-67]

An entity also has the unconditional option to skip the qualitative assessment and proceed directly to calculating the fair value of the entity (or the reporting unit) and comparing that fair value with its carrying amount, including goodwill. [350-20-35-70]

A goodwill impairment loss, if any, is measured as the amount the carrying amount of the entity (or reporting unit), including goodwill, exceeds its fair value. The goodwill impairment loss should not exceed the entity's (or reporting unit's) goodwill carrying amount. We believe the same analysis applies regardless of whether an entity's carrying amount is above, at, or below zero. Even if goodwill is deemed not to be impaired (i.e. the fair value equals or exceeds the carrying amount), the remaining useful life of goodwill is reevaluated once a triggering event has been identified. [350-20-35-73]

The following general guidance on goodwill impairments included in this Handbook is applicable to entities applying the alternative:

- the sequence of impairment testing (see [Question 4.4.10](#));
- assigning acquired assets (including goodwill) and assumed liabilities to the reporting unit when determining the carrying amount of a reporting unit (see [section 5.4](#)); and
- measuring the fair value of the entity or the reporting unit (see [chapter 8](#)).

Deferred income taxes should be included in the carrying amount of an entity (or reporting unit) when testing for impairment, regardless of whether the fair value of the entity (or reporting unit) will be determined assuming it would be bought or sold in a taxable or nontaxable transaction.

After an entity recognizes a goodwill impairment loss, the adjusted carrying amount becomes its new basis. At that time, the entity should also re-evaluate the goodwill's remaining useful life.

Goodwill's total useful life (pre- and post-impairment) should not exceed 10 years. If the entity (or the reporting unit) has more than one amortizable unit of goodwill – i.e. goodwill arose in more than one business combination or reorganization – the goodwill impairment loss should be allocated to each of those amortizable units on a pro rata basis using the relative carrying amounts of goodwill or using another reasonable and rational basis. For example, if the

entity concluded that a specific acquisition drove the impairment, the entity may conclude that it is appropriate to use a specific identification method to allocate the impairment loss).

Entities are not permitted to reverse previously recognized goodwill impairment losses.

11.5 Allocating amortization and impairment to the components of goodwill

Goodwill recognized in a business combination may be deductible for income tax purposes (i.e. tax-deductible goodwill). This typically results when goodwill for book purposes differs from the amount assigned for tax purposes because of different valuation and allocation rules and differences in determining the amount of consideration transferred (i.e. different treatment of costs incurred for a transaction). For further discussion, see section 6 of KPMG Handbook, [Accounting for income taxes](#).

[Section 9.4.20](#) discusses how to allocate an impairment loss to goodwill components (assuming the accounting alternative is not being applied), and [Question 9.4.20](#) explains the two components of goodwill.

At the acquisition date, no deferred taxes are provided on:

- first component goodwill – because by definition no basis difference will exist at the acquisition date; or
- nondeductible goodwill – i.e. second component financial statement goodwill.

However, deferred taxes are recognized at the acquisition date for basis differences related to second component tax goodwill.

Deferred tax effects of goodwill basis differences arise after the acquisition when:

- any deferred tax asset associated with second component tax goodwill reverses; or
- a basis difference arises related to first component goodwill.

A deferred tax asset should be recognized when an entity's (or a reporting unit's) first component tax goodwill exceeds first component financial statement goodwill. This can result from impairing financial statement goodwill, but can also result from amortizing financial statement goodwill.

Entities that amortize financial statement goodwill, which results in an expected reversal of the temporary difference, should also consider the effect of the amortization in the valuation allowance assessment. If an entity has first component financial statement goodwill that exceeds first component tax goodwill, a deferred tax liability should be recognized and considered as a source of taxable income on reversal. For further discussion, see section 4 of KPMG Handbook, [Accounting for income taxes](#).

The following discussion relates to the effect of amortization on first and second component goodwill. For a discussion about the effect of impairment, see [section 9.4.20](#).

[Question 9.4.60](#) provides guidance on how to allocate a goodwill impairment loss if an entity has both first and second component financial statement goodwill. That guidance allows an entity to allocate the impairment loss either:

- entirely to second component financial statement goodwill first; this results in no tax effect until the impairment exceeds the carrying amount of second component financial statement goodwill (Method A); or
- on a pro rata basis to first component and second component financial statement goodwill (Method B).

Similar guidance applies to the amortization of goodwill under the accounting alternative, and an entity has a choice of Method A or Method B.



Example 11.5.10

Goodwill amortization – tax accounting

Parent acquired Subsidiary in a taxable transaction on January 1 and elected to amortize financial statement goodwill under the accounting alternative.

The tax goodwill is amortized over 15 years and financial statement goodwill is amortized over 10 years. ABC's tax rate is 21%.

Scenario 1: Component one only

Parent recognized \$1 million of financial statement goodwill and \$1 million of tax goodwill at the date of acquisition. The tax goodwill is amortized over 15 years and financial statement goodwill is amortized over 10 years.

The deferred tax effects recognized for the year ended December 31 are as follows.

C/Amt	Book	Tax	Temp. diffs	DTA/(DTL)
Jan 1	\$1,000,000	\$1,000,000	\$ --	\$ --
Amortization	(100,000) ¹	(66,667) ²		
Dec 31	<u>\$ 900,000</u>	<u>\$ 933,333</u>	\$33,333	\$7,000 ³
Notes:				
1. \$1,000,000 ÷ 10 years.				
2. \$1,000,000 ÷ 15 years.				
3. \$33,333 (excess tax basis in first component goodwill) × 21%.				

ABC has net income of \$0 for both financial statement and tax purposes other than the amortization, and ABC is able to carry back the loss generated by the goodwill amortization.

Therefore, ABC's effective tax rate (before consideration of any valuation allowance) is 21%.

			Rate
Current tax			
Taxable loss	\$66,667	21%	
Equals current tax benefit			\$ 14,000
Deferred tax			
Deductible temporary difference	\$33,000	21%	
Equals deferred tax benefit			\$ 7,000
Total tax benefit			\$ 21,000
Divided by financial statement loss			\$100,000
Effective tax rate			21%

Scenario 2: Component one and component two financial statement goodwill – Method A

Parent recognized \$1 million of financial statement goodwill and \$750,000 of tax goodwill at the date of acquisition and elected to allocate amortization first to second component financial statement goodwill.

The deferred tax effects recognized for the year ended December 31 are as follows.

C/Amt	Book	Tax	Temp. diffs	DTA/(DTL)
Component one				
Jan 1	\$ 750,000 ¹	\$750,000	\$ --	\$ --
Amortization	--	(50,000) ³		
Dec 31	\$ 750,000	\$700,000	\$(50,000)	\$(10,500) ⁴
Component two				
Jan 1	\$ 250,000 ¹	--	\$(250,000)	\$ --
Amortization	(100,000) ²	--		
Dec 31	\$ 150,000	--	\$(150,000)	\$ --
Notes:				
1. \$1,000,000 financial statement goodwill; first component goodwill is the lesser of the financial statement goodwill and the tax goodwill at the acquisition date.				
2. \$1,000,000 ÷ 10 years = \$100,000; allocated entirely to second component financial statement goodwill until it is exhausted.				
3. \$750,000 ÷ 15 years.				
4. \$50,000 (excess tax basis in first component goodwill) × 21%.				

ABC has net income of \$0 for both financial statement and tax purposes other than the amortization and is able to carry back the loss generated by the goodwill amortization.

Therefore, ABC's effective tax rate (before consideration of any valuation allowance) is 0%.

		Rate	
Current tax			
Taxable loss	\$50,000	21%	
Equals current tax (benefit)			\$ (10,500)
Deferred tax			
Deductible temporary difference	\$50,000	21%	
Equals deferred tax benefit			\$ 10,500
Total tax benefit			--
Divided by financial statement loss			\$100,000
Effective tax rate			0%

The 21% difference between the statutory rate of 21% and the effective rate of 0% is attributable to the fact that no deferred taxes are initially or subsequently recognized for second component financial statement goodwill. Had a deferred tax benefit been recognized for the \$100,000 of second component financial statement goodwill amortization, ABC's effective rate would have been equal to the statutory rate of 21%.

Scenario 3: Component one and component two financial statement goodwill – Method B

Parent recognized \$1 million of financial statement goodwill and \$750,000 of tax goodwill at the date of acquisition and elected to allocate amortization to the first and second components of financial statement goodwill on a pro rata basis.

The deferred tax effects recognized for the year ended December 31 are as follows.

C/Amt	Book	Tax	Temp. diffs	DTA/(DTL)
Component one				
Jan 1	\$ 750,000 ¹	\$750,000	\$ --	\$ --
Amortization	(75,000) ²	(50,000) ³		
Dec 31	\$ 675,000	\$700,000	\$25,000	\$5,250 ⁴
Component two				
Jan 1	\$ 250,000 ¹	--	\$(250,000)	\$ --
Amortization	(25,000) ²	--		
Dec 31	\$ 225,000	--	\$ 225,000	\$ --
Notes:				
1. \$1,000,000 financial statement goodwill; first component goodwill is the lesser of the financial statement goodwill and the tax goodwill at the acquisition date.				
2. \$1,000,000 ÷ 10 years = \$100,000; allocated pro rata (75/25) to first and second components of financial statement goodwill.				
3. \$750,000 ÷ 15 years.				
4. \$25,000 (excess tax basis in first component goodwill) × 21%.				

ABC has net income of \$0 for both financial statement and tax purposes other than the amortization and is able to carry back the loss generated by the goodwill amortization.

Therefore, ABC's effective tax rate (before consideration of any valuation allowance) is 16%.

		Rate	
Current tax			
Taxable loss	\$50,000	21%	
Equals current tax benefit			\$ 10,500
Deferred tax			
Deductible temporary difference	\$25,000	21%	
Equals deferred tax benefit			\$ 5,250
Total tax benefit			\$ 15,750
Divided by financial statement loss			\$100,000
Effective tax rate			16%

The 5% difference between the statutory rate of 21% and the effective rate of 16% is attributable to the fact that no deferred taxes are initially or subsequently recognized for second component financial statement goodwill. Had a deferred tax benefit been recognized for the \$25,000 of second component financial statement goodwill amortization, ABC's effective rate would have been equal to the statutory rate of 21%.

11.6 Allocating goodwill to disposals



Excerpt from ASC 350-20

Accounting Alternatives

40-8 The following guidance for **goodwill** applies to entities within the scope of paragraph 350-20-15-4 that elect the accounting alternative for amortizing goodwill.

- > Disposal of a Portion of an Entity (or a Reporting Unit)

40-9 When a portion of an entity (or a **reporting unit**) that constitutes a business or nonprofit activity is to be disposed of, goodwill associated with that business or nonprofit activity shall be included in the carrying amount of the business or nonprofit activity in determining the gain or loss on disposal. An entity shall use a reasonable and rational approach to determine the amount of goodwill associated with the business or nonprofit activity to be disposed of.

When a portion of an entity (or reporting unit) that constitutes a business or not-for-profit activity is being disposed of, the associated goodwill is included in its

carrying amount when determining the gain or loss on disposal. In allocating the goodwill, an entity should use a reasonable and rational method. [350-20-40-9]

This differs from the general guidance on the disposal of all or a portion of a reporting unit when the alternative is not applied. That guidance requires entities to allocate goodwill on a relative fair value basis (see [Question 5.4.20](#)).

We believe entities may elect to use a relative fair value basis, but there also may be other reasonable methods. For example, an entity also could specifically identify the goodwill associated with the prior acquisition of the business or not-for-profit activity to be disposed of.

11.7 Presentation and disclosure



Excerpt from ASC 350-20

Accounting Alternatives

45-4 The following guidance for **goodwill** applies to entities within the scope of paragraph 350-20-15-4 that elect the accounting alternative for amortizing goodwill.

45-5 The aggregate amount of goodwill net of accumulated amortization and impairment shall be presented as a separate line item in the statement of financial position.

45-6 The amortization and aggregate amount of impairment of goodwill shall be presented in income statement or statement of activities line items within continuing operations (or similar caption) unless the amortization or a goodwill impairment loss is associated with a discontinued operation.

45-7 The amortization and impairment of goodwill associated with a discontinued operation shall be included (on a net-of-tax basis) within the results of discontinued operations.

50-3A The information in paragraphs 350-20-50-4 through 50-7 shall be disclosed in the notes to financial statements for any entity within the scope of paragraph 350-20-15-4 that elects the accounting alternative for amortizing goodwill.

> Disclosures about Additions to Goodwill

50-4 The following information shall be disclosed in the notes to financial statements for any additions to goodwill in each period for which a statement of financial position is presented:

- a. The amount assigned to goodwill in total and by major business combination, by major acquisition by a not-for-profit entity, or by reorganization event resulting in fresh-start reporting
- b. The weighted-average amortization period in total and the amortization period by major business combination, by major acquisition by a not-for-profit entity, or by reorganization event resulting in fresh-start reporting.

> Information for Each Period for Which a Statement of Financial Position Is Presented

50-5 The following information shall be disclosed in the financial statements or the notes to financial statements for each period for which a statement of financial position is presented:

- a. The gross carrying amounts of goodwill, accumulated amortization, and accumulated impairment loss
- b. The aggregate amortization expense for the period
- c. Goodwill included in a disposal group classified as held for sale in accordance with paragraph 360-10-45-9 and goodwill derecognized during the period without having previously been reported in a disposal group classified as held for sale.

> Goodwill Impairment Loss

50-6 For each goodwill impairment loss recognized, the following information shall be disclosed in the notes to financial statements that include the period in which the impairment loss is recognized:

- a. A description of the facts and circumstances leading to the impairment
- b. The amount of the impairment loss and the method of determining the fair value of the entity or the reporting unit (whether based on prices of comparable businesses or nonprofit activities, a present value or other valuation technique, or a combination of those methods)
- c. The caption in the income statement or statement of activities in which the impairment loss is included
- d. The method of allocating the impairment loss to the individual amortizable units of goodwill.

50-7 The quantitative disclosures about significant unobservable inputs used in fair value measurements categorized within Level 3 of the fair value hierarchy required by paragraph 820-10-50-2(bbb) are not required for fair value measurements related to the financial accounting and reporting for goodwill after its initial recognition in a business combination or an acquisition by not-for-profit entity.

An NFP is required to present expenses by function *and* nature in one location – in the statement of activities, a schedule in the notes or a separate financial statement. This functional analysis includes goodwill amortization expense, similar to depreciation of fixed assets and amortization of finite-lived intangible assets. For further discussion about the reporting of expenses by NFPs, see chapter 3 of KPMG Issues In-Depth, [NFP Presentation of financial statements](#). [958-220-50-1(c), 958-720-45-15]

11.8 Moving in and out of the amortization accounting alternative

11.8.10 Adopting the accounting alternative



Excerpt from ASC 350-20

65-2 The following represents the transition information related to Accounting Standards Updates No. 2014-02, *Intangibles—Goodwill and Other (Topic 350): Accounting for Goodwill*, No. 2019-06, *Intangibles—Goodwill and Other (Topic 350), Business Combinations (Topic 805), and Not-for-Profit Entities (Topic 958): Extending the Private Company Accounting Alternatives on Goodwill and Certain Identifiable Intangible Assets to Not-for-Profit Entities*, and No. 2021-03, *Intangibles—Goodwill and Other (Topic 350): Accounting Alternative for Evaluating Triggering Events* referenced in paragraph 350-20-15-3A:

- a. Upon adoption of the guidance for the accounting alternative for amortizing goodwill in the Accounting Alternatives Subsections of this Subtopic and the guidance in paragraph 323-10-35-13, that guidance shall be effective prospectively for new goodwill recognized after the adoption of that guidance. For existing goodwill, that guidance shall be effective as of the beginning of the first fiscal year in which the accounting alternative is adopted.
- b. Goodwill existing as of the beginning of the period of adoption shall be amortized prospectively on a straight-line basis over 10 years, or less than 10 years if an entity demonstrates that another useful life is more appropriate.
- c. Subparagraph superseded by Accounting Standards Update No. 2016-03.
- d. Upon adoption of the accounting alternative for amortizing goodwill, an entity shall make an accounting policy election to test goodwill for impairment at either the entity level or the reporting unit level.
- e. A private company or not-for-profit entity that makes an accounting policy election to apply the accounting alternative for amortizing goodwill in the Accounting Alternatives Subsections of this Subtopic for the first time need not justify that the use of the accounting alternative is preferable as described in paragraph 250-10-45-2.

A private company or NFP can elect the amortization accounting alternative at the beginning of any annual reporting period to existing goodwill for the first time without a preferability assessment. The election is then applied to all goodwill arising from subsequent business combinations occurring after the adoption of the amortization accounting alternative. [\[350-20-65-2\]](#)

Based on discussions with the FASB staff, under the transition guidance we believe a private company or NFP has flexibility in defining its adoption period as its annual or an interim reporting period (including an interim period other than the first quarter) as long as the financial statements for that period have not yet been made available for issuance.

If adopted at an interim period other than the first interim period of the year, the guidance is applied prospectively to existing goodwill as of the beginning of the first fiscal year in which the amortization accounting alternative is adopted.

We believe application to annual financial statements that have not been made available for issuance will be acceptable even if an entity has made quarterly interim financial statements available for issuance before electing the alternative. For example, an entity that has not made its 2019 annual financial statements available for issuance may apply the amortization accounting alternative to its 2019 annual financial statements even if it had previously issued financial statements for an earlier interim period in that year.

If the alternative is first elected in an entity's annual financial statements for the fiscal year ended December 31, 2019, the beginning of the period of adoption is the beginning of that fiscal year – i.e. January 1, 2019.

For some entities, adopting the goodwill amortization accounting alternative has an effect on their valuation allowance assessment because existing deferred tax liabilities related to the first component of goodwill will now reverse as financial statement goodwill is amortized – whereas previously, those deferred tax liabilities had an indefinite reversal period.

In this situation, we believe the entity should recognize the change in the valuation allowance through income from continuing operations. This is because it represents a change in judgment about the recoverability of the beginning of the year deferred tax asset due to changes in the expectation of income that would be generated by the entity in the current and future periods.

This approach is consistent with the guidance on the tax effects of changes in the valuation allowance caused by changes in circumstances that result in a change in judgment about an entity's ability to realize deferred tax assets in future years. These tax effects are charged to the income statement as a component of income from continuing operations. [740-10-45-20]



Example 11.8.10

Valuation allowance on adoption of amortization accounting alternative

ABC Corp. has a deferred tax liability (DTL) related to the difference between the financial statement and tax basis of goodwill. ABC has previously recorded a valuation allowance on all of its deferred tax assets (DTA) as it has determined it is more likely than not that it will not be able to realize its DTAs.

As a result of electing the goodwill amortization accounting alternative, ABC has determined that the reversal of the DTL related to the basis difference of goodwill can be considered a source of taxable income in assessing the realizability of its DTAs (previously the reversal period was determined to be indefinite and the DTL was not expected to reverse in the same period as existing DTAs).

The DTL related to the basis difference of goodwill will eventually be reduced to zero as ABC recognizes goodwill amortization and can now be scheduled. Based on the taxable income that would be generated by the reversal of the

DTL, ABC has determined that a valuation allowance on a portion of its DTAs is no longer needed.

ABC recognizes the change in the valuation allowance through income from continuing operations.

11.8.20 Ceasing to apply the amortization accounting alternative

If a private company wishes to discontinue using the goodwill amortization accounting alternative, it needs to:

- also discontinue its use of the accounting alternative for identifiable intangible assets (see KPMG Handbook, [Business combinations](#));
- retrospectively eliminate both alternatives under the accounting change requirements of Topic 250; see chapter 3 of KPMG Handbook, [Accounting changes and error corrections](#); and
- justify the change as preferable; in general, we believe the alternative accounting policies to be less preferable.

A. Goodwill impairment pre-ASU 2017-04

Detailed contents

A.1 About ASU 2017-04

A.2 The mechanics of 'Step 2'

Questions

- A.2.10 How is Step 2 of the quantitative test applied?
- A.2.20 Is an assembled workforce intangible asset recognized in Step 2 of the quantitative test?

Example

- A.2.10 Goodwill impairment test pre-ASU 2017-04

A.3 Reporting unit with a negative carrying amount

Question

- A.3.10 How is the impairment test applied if a reporting unit has a negative carrying amount?

A.4 Deferred taxes

Questions

- A.4.10 How are deferred taxes considered in Step 2 of the goodwill impairment test?
- A.4.20 Is the need for a valuation allowance considered in calculating implied goodwill?
- A.4.30 How is the implied fair value of goodwill calculated when a nontaxable transaction is assumed?
- A.4.40 How is goodwill impairment allocated between deductible and nondeductible goodwill?
- A.4.50 How is goodwill impairment allocated to a reporting unit with multiple tax jurisdictions?

Examples

- A.4.10 Implied fair value of goodwill in a nontaxable transaction
- A.4.20 Allocating goodwill impairment
- A.4.30 Allocating goodwill impairment to lower levels within a reporting unit

A.5 Adoption of ASU 2017-04

Questions

- A.5.10 In the year of adopting ASU 2017-04 can an entity immediately apply the one-step impairment test if it applied the two-step test earlier in the year?
- A.5.20 Under what circumstances might the adoption of ASU 2017-04 trigger the need for impairment testing?

A.1 About ASU 2017-04

Issued in 2017, ASU 2017-4, Simplifying the Test for Goodwill Impairment, was designed to reduce the cost and complexity of accounting for goodwill.

The main discussion in this Handbook assumes that ASU 2017-4 has been adopted. This appendix outlines the differences in goodwill impairment testing for those entities that have not yet adopted the ASU.

Before adoption	After adoption
<ul style="list-style-type: none"> — Step 1 of the impairment test identifies potential impairment – the same as the single-step quantitative test after adoption (chapter 8). — Step 2 of the impairment test measures the impairment (section A.2). 	<p>Single-step quantitative test identifies and measures impairment (chapter 8).</p>
<p>Specific requirements for reporting units with zero or negative carrying amounts (section A.3).</p>	<p>No specific requirements for reporting units with zero or negative carrying amounts; disclosure required (section 10.2).</p>

For calendar year-end entities, ASU 2017-04 is effective for annual and interim impairment tests in periods beginning on the following dates, with early adoption permitted for interim and annual goodwill impairment tests with a measurement date after January 1, 2017: [[ASU 2017-04](#), [ASU 2019-10](#)]

- SEC filers, January 1, 2020
- Other entities, January 1, 2023.

A.2 The mechanics of 'Step 2'



Excerpt from ASC 350-20

- > Step 2

35-9 The second step of the goodwill impairment test, used to measure the amount of impairment loss, compares the implied fair value of reporting unit goodwill with the carrying amount of that goodwill.

35-10 The guidance in paragraphs 350-20-35-14 through 35-17 shall be used to estimate the implied fair value of goodwill.

35-11 If the carrying amount of reporting unit goodwill exceeds the implied fair value of that goodwill, an impairment loss shall be recognized in an amount equal to that excess. The loss recognized cannot exceed the carrying amount of goodwill.

- > Determining the Implied Fair Value of Goodwill

35-14 The implied fair value of goodwill shall be determined in the same manner as the amount of goodwill recognized in a business combination or an **acquisition by a not-for-profit entity** was determined. That is, an entity shall assign the fair value of a reporting unit to all of the assets and liabilities of that unit (including any unrecognized intangible assets) as if the reporting unit had been acquired in a business combination or an acquisition by a not-for-profit entity. Throughout this Section, the term business combination includes an acquisition by a not-for-profit entity.

35-16 The excess of the fair value of a reporting unit over the amounts assigned to its assets and liabilities is the implied fair value of goodwill.

35-17 That assignment process discussed in paragraphs 350-20-35-14 through 35-16 shall be performed only for purposes of testing goodwill for impairment; an entity shall not write up or write down a recognized asset or liability, nor shall it recognize a previously unrecognized intangible asset as a result of that allocation process.

Step 2 of the quantitative test requires an entity to calculate goodwill as if the business (reporting unit) was acquired in a business combination at the date of the impairment test. The amount of goodwill calculated in this hypothetical acquisition accounting – referred to as the implied fair value of goodwill – is compared to the carrying amount of goodwill to measure the impairment loss, if any.



Question A.2.10

How is Step 2 of the quantitative test applied?

Interpretive response: To determine the amount of any impairment of goodwill, an entity performs acquisition accounting as if the reporting unit were acquired in a business combination at the date of the impairment test.

Assign reporting unit's fair value to unit's assets and liabilities

To implement Step 2, an entity first assigns the reporting unit's fair value – which it determined in Step 1 – to the unit's assets and liabilities; the reporting unit's fair value is measured as described in [chapter 8](#). This assignment process requires the reporting unit's assets and liabilities to be identified, recognized and measured as they would be under the acquisition method of accounting described in Topic 805; see section 7 of KPMG Handbook, [Business combinations](#). [350-20-35-14]

This hypothetical purchase price allocation is required even if the underlying assets of the reporting unit were not originally acquired in a business combination accounted for under Topic 805.

The assignment process is for purposes of the impairment test only. Recognized assets and liabilities are not adjusted to fair value for financial

reporting purposes, and previously unrecognized intangible assets are not recorded in Step 2 of the goodwill impairment process. [350-20-35-17]

In the hypothetical purchase price allocation, fair value is assigned to tangible net assets and to both recognized and unrecognized intangible assets at the impairment testing date. In the period since the original acquisition date, the reporting unit may have internally developed intangible assets (e.g. patents, trademarks, customer relationships) for which the costs were expensed as incurred for accounting purposes.

These internally developed intangible assets are included in the fair value of the reporting unit in Step 1 (see [chapter 8](#)) and are therefore included in the assignment of that fair value in Step 2.

A reporting unit with significant (or growing) amounts of unrecognized intangible assets is less likely to have a goodwill impairment loss than a reporting unit that lacks significant amounts of unrecognized intangible assets. This is because it is less likely to have an indicator of goodwill impairment under Step 1 due to the increased fair value of the reporting unit.

Calculate implied fair value of reporting unit goodwill

The fair value of tangible net assets and both recognized and unrecognized intangible assets (e.g. internally developed intangible assets) is deducted from the fair value of the reporting unit to determine the implied fair value of reporting unit goodwill. If the implied fair value of reporting unit goodwill is lower than its carrying amount, goodwill is impaired and written down to its implied fair value. The recognized loss cannot exceed the carrying amount of goodwill.

On recognition of a goodwill impairment loss, the adjusted amount of goodwill becomes the new carrying amount for future impairment testing. Once a loss is recognized, future increases in fair value will not result in reversal of the previously recognized loss.



Example A.2.10

Goodwill impairment test pre-ASU 2017-04

ABC Corp. has a single reporting unit that has recognized net assets of \$780, including goodwill of \$500. The fair value of Reporting Unit is \$650, which includes the fair value of two internally developed, unrecognized intangible assets (a patent and a customer list).

	C/Amt	FV	Diffs
Tangible net assets	\$ 80	\$110	\$ 30
Recognized intangible assets	200	230	30
Goodwill	500	110	(390)
Unrecognized intangible assets	--	200	200
Total	\$780	\$650	\$(130)

The implied fair value of goodwill is arrived at through a residual method, as shown in the following steps.

Step 1: Indicator of impairment

As shown in the table, the carrying amount of Reporting Unit's net assets exceeds its fair value. Therefore, the entity proceeds to Step 2.

Fair value of Reporting Unit (including unrecognized intangible assets)	\$ 650
Carrying amount of reporting unit net assets, including goodwill	(780)
Difference	\$(130)

Step 2: Measurement of impairment

As shown in the table, if Reporting Unit were acquired in a business combination at the impairment testing date, goodwill would be \$110. Comparing that implied goodwill to its carrying amount, goodwill is impaired by \$390.

Fair value of Reporting Unit	\$ 650
Fair value of tangible net assets	(110)
Fair value of recognized intangible assets	(230)
Fair value of unrecognized intangibles (patent and customer list)	(200)
Implied fair value of goodwill	110
Carrying amount of goodwill	(500)
Goodwill impairment loss	\$(390)



Question A.2.20

Is an assembled workforce intangible asset recognized in Step 2 of the quantitative test?

Interpretive response: Under Step 2, fair value is assigned to the assets and liabilities of the reporting unit, including intangible assets, only if they meet the criteria in Topic 805 for recognition apart from goodwill. [350-20-35-14]

An assembled workforce may have previously been recognized as an intangible asset because it was part of an acquired group of assets not constituting a business (i.e. an asset acquisition). However, for purposes of Step 2, any fair value attributable to that assembled workforce intangible is subsumed into the implied fair value of a reporting unit's goodwill, as it would have been in the acquisition of a business.

A.3 Reporting unit with a negative carrying amount



Excerpt from ASC 350-20

- > Step 1

35-6 If the carrying amount of a reporting unit is greater than zero and its fair value exceeds its carrying amount, goodwill of the reporting unit is considered not impaired; thus, the second step of the impairment test is unnecessary. If the carrying amount of the reporting unit is zero or negative, the guidance in paragraph 350-20-35-8A shall be followed.

35-8A If the carrying amount of a reporting unit is zero or negative, the second step of the impairment test shall be performed to measure the amount of impairment loss, if any, when it is more likely than not (that is, a likelihood of more than 50 percent) that a goodwill impairment exists. In considering whether it is more likely than not that a goodwill impairment exists, an entity shall evaluate, using the process described in paragraphs 350-20-35-3F through 35-3G, whether there are adverse qualitative factors, including the examples of events and circumstances provided in paragraph 350-20-35-3C(a) through (g). In evaluating whether it is more likely than not that the goodwill of a reporting unit with a zero or negative carrying amount is impaired, an entity also should take into consideration whether there are significant differences between the carrying amount and the estimated fair value of its assets and liabilities, and the existence of significant unrecognized intangible assets.

A reporting unit to which goodwill has been assigned may have a negative carrying amount. Just like for a reporting unit with a positive carrying amount, an entity is required to perform Step 2 of the goodwill impairment test for a reporting unit with a negative carrying amount if it is more likely than not that a goodwill impairment exists (see [chapter 6](#)).



Question A.3.10

How is the impairment test applied if a reporting unit has a negative carrying amount?

Interpretive response: If a reporting unit has a negative carrying amount, the entity bypasses Step 1. Instead, if it is more likely than not that goodwill is impaired following a qualitative assessment (see [chapter 6](#)), the entity proceeds directly to Step 2 (see [section A.2](#)).

A.4 Deferred taxes

[Section 9.4.20](#) discusses the two components of goodwill and how to allocate an impairment loss to those components for tax purposes; that discussion is not repeated here. However, pre-ASU 2017-04 another issue arises, which is how to account for deferred taxes in the Step 2 calculation of implied goodwill.



Question A.4.10

How are deferred taxes considered in Step 2 of the goodwill impairment test?

Interpretive response: Temporary differences for which deferred taxes are reflected in the Step 2 calculation of implied goodwill are determined as the differences between the amounts assigned in the hypothetical application of the acquisition method and the assumed tax bases of those assets and liabilities. The assumed tax bases should be those resulting from the tax structure assumed when estimating the fair value of the reporting unit in Step 1 (see [section 8.3.30](#)).

Therefore, if the fair value of the reporting unit determined in Step 1 was based on the assumption that the reporting unit would be sold in a taxable transaction, the tax bases of all assets (including goodwill) should be adjusted to their respective fair values. Because the hypothetical book and tax bases should be approximately equal in an assumed taxable transaction, generally no deferred tax assets or liabilities would be identified in the hypothetical application of the acquisition method.

For example, assume a deferred tax asset is currently recognized in the financial statements of a reporting unit as a result of a previous writeoff of an asset for financial reporting purposes that has a remaining tax basis. If that asset's fair value was \$0 at the impairment testing date and the assumed tax structure in Step 1 was a taxable transaction, that deferred tax asset recognized by the reporting unit would not be identified in the hypothetical application of the acquisition method in Step 2. This is because the hypothetical book and tax basis of the asset would both be assumed to be \$0.

Alternatively, if the assumed tax structure in Step 1 was a nontaxable transaction, the existing tax basis of the asset would remain and be used in calculating a deferred tax asset in the Step 2 test, because the hypothetical book basis of the asset would be \$0.

The accounting is illustrated in [Example 1](#) in Subtopic 350-20.



Excerpt from ASC 350-20

- > Example 1: Impairment Test When either a Taxable or Nontaxable Transaction Is Feasible

55-10 This Example illustrates the effect of a nontaxable transaction on the

impairment test of goodwill. The Example may not necessarily be indicative of actual income tax liabilities that would arise in the sale of a reporting unit or the relationship of those liabilities in a taxable versus nontaxable structure.

55-11 Entity A is performing a goodwill impairment test relative to Reporting Unit at December 31, 20X2. Reporting Unit has the following assets and liabilities:

- a. Net assets (excluding goodwill and deferred income taxes) of \$60 with a tax basis of \$35
- b. Goodwill of \$40
- c. Net deferred tax liabilities of \$10

55-12 Entity A believes that it is feasible to sell Reporting Unit in either a nontaxable or a taxable transaction. Entity A could sell Reporting Unit for \$80 in a nontaxable transaction or \$90 in a taxable transaction. If Reporting Unit were sold in a nontaxable transaction, Entity A would have a current tax payable resulting from the sale of \$10. Assuming a tax rate of 40 percent, if Reporting Unit were sold in a taxable transaction, Entity A would have a current tax payable resulting from the sale of \$22 $(\$90 - 35) \times 40\%$. The fair value of the net tangible and identifiable intangible assets in Reporting Unit is \$65, before consideration of deferred income taxes.

55-13 In Step 1 of the impairment test in paragraphs 350-20-35-4 through 35-8, Entity A concludes that market participants would act in their economic best interest by selling Reporting Unit in a nontaxable transaction based on the following evaluation of its expected after-tax proceeds.

	Nontaxable	Taxable
Gross proceeds (fair value)	\$ 80	\$ 90
Less: taxes arising from transaction	(10)	(22)
Value to Entity A	<u>\$ 70</u>	<u>\$ 68</u>

55-14 In Step 1 of the impairment test, Entity A would determine the carrying value of Reporting Unit as follows.

Net assets	\$ 60
Goodwill	40
Deferred taxes	(10)
Carrying value	<u>\$ 90</u>

55-15 Reporting Unit fails Step 1 of the goodwill impairment test as its carrying value (\$90) exceeds its fair value (\$80 assuming a nontaxable transaction). Entity A must perform Step 2 of the goodwill impairment test in paragraphs 350-20-35-9 through 35-13. Because Entity A assumed that Reporting Unit would be sold in a nontaxable transaction, the analysis in Step 2 is as follows.

	Assumed Allocation of Fair Value (Purchase Price)
Fair value of Reporting Unit	\$ 80
Less: fair value of net tangible and identifiable intangible assets	(65)
Plus deferred tax liabilities $(\$65 - \$35 = \$30 \times 40\% = \$12)$	12
Implied fair value of goodwill	<u>\$ 27</u>

55-16 Reporting Unit must recognize a goodwill impairment of \$13 (determined as the carrying value of goodwill of \$40 compared to its implied fair value of \$27).

- > Example 2: Impairment Test When Either a Taxable or Nontaxable Transaction Is Feasible

55-17 This Example illustrates the effect of a taxable transaction on the impairment test of goodwill. The Example may not necessarily be indicative of actual income tax liabilities that would arise in the sale of a reporting unit or the relationship of those liabilities in a taxable versus nontaxable structure.

55-18 Entity A is performing a goodwill impairment test relative to Reporting Unit at December 31, 20X2. Reporting Unit has the following assets and liabilities:

- Net assets (excluding goodwill and deferred income taxes) of \$60 with a tax basis of \$35
- Goodwill of \$40
- Net deferred tax liabilities of \$10.

55-19 Entity A believes that it is feasible to sell Reporting Unit in either a nontaxable or a taxable transaction. Entity A could sell Reporting Unit for \$65 in a nontaxable transaction or \$80 in a taxable transaction. If Reporting Unit were sold in a nontaxable transaction, Entity A would have a current tax payable resulting from the sale of \$4. Assuming a tax rate of 40 percent, if Reporting Unit were sold in a taxable transaction, Entity A would have a current tax payable resulting from the sale of \$18 ($[\$80 - 35] \times 40\%$). The fair value of the net tangible and identifiable intangible assets in Reporting Unit is \$65, before consideration of deferred income taxes.

55-20 In Step 1 of the impairment test in paragraphs 350-20-35-4 through 35-8, Entity A concludes that market participants would act in their economic best interest by selling Reporting Unit in a taxable transaction. This conclusion was based on the following.

	Nontaxable Transaction	Taxable Transaction
Gross proceeds (fair value)	\$ 65	\$ 80
Less: taxes arising from transaction	(4)	(18)
Value to Entity A	<u>\$ 61</u>	<u>\$ 62</u>

55-21 Deferred taxes related to the net assets of Reporting Unit should be included in the carrying value of Reporting Unit. Accordingly, in Step 1 of the impairment test Entity A would determine the carrying value of Reporting Unit as follows.

Net assets	\$ 60
Goodwill	40
Deferred income taxes	(10)
Carrying value	<u>\$ 90</u>

55-22 Reporting Unit fails Step 1 because its carrying value (\$90) exceeds its fair value (\$80); therefore, Entity A must perform Step 2 of the goodwill impairment test (see paragraphs 350-20-35-9 through 35-13). Because Entity A assumed that Reporting Unit would be sold in a taxable transaction, the

calculation of the implied fair value of goodwill in Step 2 of the impairment analysis is as follows.

Fair value of Reporting Unit	\$ 80
Less:	
Fair value of net tangible and intangible assets	(65)
Deferred income taxes	-
Implied fair value of goodwill	<u>\$ 15</u>

55-23 Reporting Unit must recognize a goodwill impairment of \$25 (determined as the carrying value of goodwill of \$40 compared to its implied fair value of \$15).



Question A.4.20

Is the need for a valuation allowance considered in calculating implied goodwill?

Interpretive response: Yes. When calculating the implied fair value of goodwill in Step 2, a deferred tax asset valuation allowance should be measured at an amount that is consistent with the results that would be recognized in a purchase price allocation in connection with a business combination.

For example, if the reporting unit has deferred tax assets with an existing valuation allowance, that valuation allowance may not be included in the Step 2 calculation because the hypothetical application of the acquisition method gives rise to deferred tax liabilities that reverse within the same carryforward period as the deferred tax assets. Disregarding the valuation allowance in this way is for the impairment test only and does not give rise to an adjustment of the valuation allowance for financial reporting purposes.



Question A.4.30

How is the implied fair value of goodwill calculated when a nontaxable transaction is assumed?

Interpretive response: The implied fair value of goodwill is calculated in the same way as goodwill recognized in a business combination. [350-20-35-14]

Therefore, the calculation should include any excess of the tax basis of goodwill over the implied fair value of goodwill. In the context of a business combination, excess goodwill is referred to as second component tax goodwill.

When a nontaxable transaction yields the highest economic value, the amounts used in Step 2 to measure the tax bases of the net assets are the historical tax bases of the reporting unit, including the historical tax basis of goodwill. As such, deferred taxes are measured based on the difference between the fair value of the net assets and the historical tax bases of those net assets.

However, because the amount of implied goodwill is determined in the same manner as goodwill is determined in a business combination, the amount of implied goodwill depends on the amount of deferred taxes recognized – which

in turn depends on the difference between the implied goodwill and the tax basis of the goodwill (i.e. its historical tax basis).

To solve this circular problem, an entity calculates the implied fair value of goodwill and associated deferred tax benefit using the simultaneous equation used in business combinations. The adjustment to deferred taxes and to the implied fair value of goodwill is calculated as follows.

$$\frac{\text{tax rate}}{1 - \text{tax rate}} \times \text{initial implied goodwill}$$



Example A.4.10

Implied fair value of goodwill in a nontaxable transaction

ABC Corp. is performing a goodwill impairment test for Reporting Unit, which has the following assets and liabilities:

- Carrying amount of net assets (excluding goodwill and deferred taxes), \$600
- Tax bases of net assets, \$350
- Fair value of net identifiable assets, \$650
- Goodwill – book and tax basis, \$400
- Net deferred tax liabilities, \$50

The fair value of Reporting Unit is \$780; this assumes a nontaxable transaction because it yielded the highest economic value. ABC has a tax rate of 21%.

As shown in the table, ABC calculates an initial implied fair value of goodwill of \$210.

Fair value of Reporting Unit	\$780
Fair value of net identifiable assets	(650)
Deferred tax liabilities: $(\$650 - \$350) \times 21\%$	60
Goodwill implied fair value (preliminary)	<u>\$190</u>
Preliminary temporary difference: $\$400 - \190	<u>\$210</u>

Next, ABC applies the simultaneous equation to determine the amount of deferred tax and the adjustment to the initial \$210 implied fair value of goodwill.

$$\frac{\text{tax rate}}{1 - \text{tax rate}} \times \text{initial implied goodwill}$$

$$(21\% \div (1 - 21\%)) \times \$210 = \$56$$

Therefore, an adjustment of \$56 is required – implied goodwill is \$134 ($\$190 - \56) and there is a deferred tax asset of \$56.

The deferred tax asset can be verified as follows.

$$(\text{tax goodwill} - \text{book goodwill}) \times \text{tax rate}$$

$$(\$400 - \$134) \times 21\% = \$56$$



Question A.4.40

How is goodwill impairment allocated between deductible and nondeductible goodwill?

Interpretive response: If the first component of financial statement goodwill becomes impaired such that first component tax goodwill exceeds the first component of financial statement goodwill, a deferred tax asset is recognized. An impairment of first component financial statement goodwill may also result in a reduction of a deferred tax liability that was recognized for an excess of first component financial statement goodwill over first component tax goodwill before the impairment charge.

If a reporting unit has second component financial statement goodwill (nondeductible goodwill), the goodwill impairment could be allocated using either of the following methods.

- **Method A.** To the extent possible, allocate the impairment loss to any second component financial statement goodwill. Allocate any remaining impairment loss to first component goodwill.
- **Method B.** Allocate the impairment on a pro rata basis to the reporting unit's first component and second component financial statement goodwill.

An offsetting deferred tax asset (or reduction in a deferred tax liability) is recognized for the impairment allocated only to the reporting unit's first component financial statement goodwill. There is no tax effect from the impairment of nondeductible goodwill (second component financial statement goodwill). Therefore, an entity that has elected Method A would recognize \$0 tax effect if the goodwill impairment amount was less than or equal to the second component financial statement goodwill.



Example A.4.20

Allocating goodwill impairment

ABC Corp. is performing a goodwill impairment test for Reporting Unit and concludes that goodwill is impaired by \$350. ABC's tax rate is 21%.

Scenario 1: Tax goodwill exceeds financial statement goodwill

ABC's goodwill and related deferred taxes before impairment are as follows.

	Financial statements	Tax basis	DTA/(DTL)
First component	\$600	\$600	\$ --
Second component	--	300	63
Total goodwill	\$600	\$900	\$63

ABC's goodwill and related deferred taxes after impairment are as follows.

	Financial statements	Tax basis	DTA/(DTL)
First component	\$250 ¹	\$600	\$74 ²
Second component	--	300	63
Total goodwill	\$250	\$900	\$137
Notes:			
1.	\$600 - \$350.		
2.	(\$600 - \$250) × 21%.		

Scenario 2: First component financial statement goodwill exceeds first component tax goodwill

ABC's goodwill and related deferred taxes before impairment are as follows.

	Financial statements	Tax basis	DTA/(DTL)
First component	\$600	\$200	\$(84)
Second component	--	--	--
Total goodwill	\$600	\$200	\$(84)

ABC's goodwill and related deferred taxes after impairment are as follows.

	Financial statements	Tax basis	DTA/(DTL)
First component	\$250 ¹	\$200	\$(11) ²
Second component	--	--	--
Total goodwill	\$250	\$200	\$(11)
Notes:			
1.	\$600 - \$350.		
2.	(\$200 - \$250) × 21%.		

Scenario 3: Reporting unit has second component financial statement goodwill

ABC's goodwill and related deferred taxes before impairment are as follows.

	Financial statements	Tax basis	DTA/(DTL)
First component	\$ 900	\$800	\$(21)
Second component	300	--	--
Total goodwill	\$1,200	\$800	\$(21)

Because ABC has excess financial statement goodwill, it could apply Method A or Method B outlined in [Question A.4.20](#).

Method A

ABC's goodwill and related deferred taxes after impairment are as follows.

	Financial statements	Tax basis	DTA/(DTL)
First component	\$850 ¹	\$800	\$(11) ²
Second component	--	--	--
Total goodwill	\$850	\$800	\$(11)
Notes:			
1. \$900 - \$50; the first \$300 was used to reduce component two goodwill to zero.			
2. $(\$800 - \$850) \times 21\%$.			

Method B

The impairment loss of \$350 is allocated on a pro rata basis to the first component and second component financial statement goodwill (rounded):

- First component: $\$350 \times (\$900 / \$1,200) = \263
- Second component: $\$350 \times (\$300 / \$1,200) = \87

ABC's goodwill and related deferred taxes after impairment are as follows.

	Financial statements	Tax basis	DTA/(DTL)
First component	\$637 ¹	\$800	\$34 ²
Second component	213 ³	--	--
Total goodwill	\$780	\$800	\$34
Notes:			
1. \$900 - \$263.			
2. $(\$800 - \$637) \times 21\%$.			
3. \$300 - \$87.			



Question A.4.50

How is goodwill impairment allocated to a reporting unit with multiple tax jurisdictions?

Interpretive response: Question A.4.40 discusses how to allocate the impairment loss if a reporting unit has second component financial statement goodwill (nondeductible goodwill). If there is more than one separate tax-paying legal entity or tax jurisdiction within the reporting unit, the entity may need to further allocate the impairment to those lower levels.

The allocation processes discussed in this interpretive response should result in:

- none of the first component financial statement goodwill impairment being allocated to lower levels that, pre-impairment, have no first component financial statement goodwill; and

- none of the second component financial statement goodwill impairment being allocated to lower levels that, pre-impairment, have no second component financial statement goodwill.

Entity elects Method A

Under Method A, the impairment loss is allocated to second component financial statement goodwill to the extent possible. See [Example A.4.20](#).

If the entire impairment loss is allocated to second component financial statement goodwill, one acceptable method of allocation would be a pro rata allocation of the impairment at the reporting unit level to those lower levels that, pre-impairment, have second component financial statement goodwill.

That allocation could be based on the proportion of pre-impairment second component financial statement goodwill at the jurisdictional/legal entity level to the total pre-impairment second component financial statement goodwill at the reporting unit level.

Entity elects Method B

Under Method B, the impairment loss is allocated on a pro rata basis to the reporting unit's first component and second component financial statement goodwill. See [Example A.4.20](#).

An entity could apply the same principle discussed above for Method A as follows.

1. Determine how much impairment will be allocated to first and second component goodwill based on the pro rata calculation at the reporting unit level (i.e. apply Method B).
2. Determine each lower level's proportion of the reporting unit's total first and second components of goodwill.
3. Take the impairment loss attributed to each component at the reporting unit level (determined in (1)) and allocate it to the lower levels based on the proportions determined in (2).



Example A.4.30

Allocating goodwill impairment to lower levels within a reporting unit

Reporting Unit comprises two subsidiaries (Subs A and B) of ABC Corp. that are located in different tax-paying jurisdictions.

The following is the pre-impairment allocation of goodwill within Reporting Unit. The second component financial statement goodwill is nondeductible.

	Sub A	Sub B	Total RU
First component	\$100	\$50	\$150
Second component	200	—	200
Total goodwill	\$300	\$50	\$350

ABC is performing a goodwill impairment test for Reporting Unit and concludes that goodwill is impaired by \$100.

Scenario 1: ABC elects Method A

Under Method A, the impairment loss is allocated to second component financial statement goodwill to the extent possible.

ABC allocates the entire \$100 impairment loss to Sub A because only Sub A has second component financial statement goodwill; therefore, its proportionate share is 100%. There is no related income tax effect.

Scenario 2: ABC elects Method B

Under Method B, the impairment loss is allocated on a pro rata basis to the reporting unit's first component and second component financial statement goodwill.

Step 1. ABC determines how much of the initial impairment loss will be allocated to first and second component goodwill based on the pro rata calculation at Reporting Unit level.

	Total RU	Calculation	Allocation
First component	\$150	$\$100 \times (\$150 / \$350)$	\$ 43
Second component	200	$\$100 \times (\$200 / \$350)$	57
Total	\$350		\$100

Step 2. ABC determines Sub A's and Sub B's proportion of Reporting Unit's total first and second components of goodwill

First component	Goodwill	Calculation	% share of RU
Sub A	\$100	$\$100 \div \150	67%
Sub B	50	$\$50 \div \150	33%
RU total	\$150		100%

Second component	Goodwill	Calculation	Allocation
Sub A	\$200	$\$200 \div \200	100%
Sub B	--	--	--
RU total	\$200		100%

Step 3. ABC multiplies the impairment attributed to each component at Reporting Unit level determined in Step 1 by the Sub A and Sub B proportions determined in Step 2.

Sub A	C/Amt before	Allocation	C/Amt after
First component	\$100	$\$43 \times 67\% = \29	\$ 71
Second component	200	$\$57 \times 100\% = \57	143
Total	\$300		\$214

Sub B	C/Amt before	Allocation	C/Amt after
First component	\$50	$\$43 \times 33\% = \14	\$36
Second component	—	—	—
Total	\$50		\$36

The following table shows the allocation of goodwill after recognition of the impairment loss.

	Sub A	Sub B	Total RU
First component	\$ 71 ¹	\$36 ²	\$107
Second component	143 ³	—	143
Total goodwill	\$214	\$36	\$250⁴
Notes:			
1. \$100 - \$29 (Step 3).			
2. \$50 - \$14 (Step 3).			
3. \$200 - \$57 (Step 3).			
4. \$350 - \$100 (Step 1).			

Note: Goodwill impairment and related deferred taxes in the separate financial statements of Sub A and Sub B may differ from the amounts above depending on how those subsidiaries identify their reporting units and their policies for intercorporate tax allocation.

A.5 Adoption of ASU 2017-04

ASU 2017-04 is applied prospectively for annual and interim goodwill impairment tests in fiscal years beginning after: [\[ASU 2017-04, ASU 2019-10\]](#)

- SEC filers, January 1, 2020
- Other entities, January 1, 2023.



Question A.5.10

In the year of adopting ASU 2017-04 can an entity immediately apply the one-step impairment test if it applied the two-step test earlier in the year?

Interpretive response: No. We believe an entity should apply the same impairment model consistently for all goodwill impairment tests performed within a fiscal year.

This means that an entity may not adopt ASU 2017-04 in the middle of a fiscal year if it has already performed one or more impairment tests during that fiscal year using the two-step model. This view is consistent with the basis for conclusions to ASU 2017-04, which states: “The Board notes that an entity

should apply the same guidance to an interim impairment test as the guidance it plans to use for its annual test in the year of adoption.” [ASU 2017-04.BC64]

Therefore, a non-SEC filer that wishes to early adopt ASU 2017-04 needs to determine if adoption is permitted. Adoption in a fiscal year is precluded if an impairment test earlier in that fiscal year applied the former impairment guidance (Step 2 test measuring the impairment using implied goodwill).



Question A.5.20

Under what circumstances might the adoption of ASU 2017-04 trigger the need for impairment testing?

Interpretive response: Regardless of the timing of an entity's adoption of ASU 2017-04, if a reporting unit failed Step 1 but passed Step 2 in the most recent annual impairment test, goodwill of that reporting unit has a high likelihood of impairment upon adoption of the one-step model.

This is because impairment then will be measured based on Step 1, and the previously failed Step 1 would be an indicator that likely would trigger an interim impairment test on adoption.

Index of changes

This index lists the significant additions and changes made in this edition to assist you in locating recently added or updated content. The significantly updated or revised Question in this edition is identified with #.

8. Fair value measurement

Question

- 8.3.30 What adjustments are made to enterprise value to derive equity value? #

KPMG Financial Reporting View



Insights for financial reporting professionals

Delivering guidance, publications and insights, KPMG Financial Reporting View is ready to inform your decision-making. Stay up to date with our books, newsletters, articles, podcasts and webcasts.

Visit kpmg.com/us/frv for news and analysis of significant decisions, proposals, final standards and trending issues.



Reference library



CPE



Newsletter sign-up



Follow us on social

kpmg.com/us/frv

Insights for financial reporting professionals

US GAAP Handbooks

As part of [Financial Reporting View](#), our library of in-depth guidance can be accessed [here](#), including the following Handbooks.

- [Accounting changes and error corrections](#)
- [Asset acquisitions](#)
- [Bankruptcies](#)
- [Business combinations](#)
- [Climate risk in the financial statements](#)
- [Consolidation](#)
- [Credit impairment](#)
- [Debt and equity financing](#)
- [Derivatives and hedging](#)
- [Discontinued operations and held-for-sale disposal groups](#)
- [Earnings per share](#)
- [Employee benefits](#)
- [Equity method of accounting](#)
- [Fair value measurement](#)
- [Financial statement presentation](#)
- [Foreign currency](#)
- [GHG emissions reporting](#)
- [Going concern](#)
- [IFRS® compared to US GAAP](#)
- [Impairment of nonfinancial assets](#)
- [Income taxes](#)
- [Investments](#)
- [Leases](#)
- [Leases: Real estate lessors](#)
- [Long-duration contracts](#)
- [Reference rate reform](#)
- [Research and development](#)
- [Revenue recognition](#)
- [Revenue: Real estate](#)
- [Revenue: Software and SaaS](#)
- [Segment reporting](#)
- [Service concession arrangements](#)
- [Share-based payment](#)
- [Software and website costs](#)
- [Statement of cash flows](#)
- [Tax credits](#)
- [Transfers and servicing of financial assets](#)

Acknowledgments

This Handbook has been produced by the Department of Professional Practice of KPMG LLP in the United States.

We would like to acknowledge the efforts of the main contributors to this Handbook:

Frederik Bort

Nick Burgmeier

Dan Langlois

Justin Miller

Scott Muir

Julie Santoro

Brian Stewart

Landon Westerlund

We would also like to acknowledge the significant contributions of the following: Kimber Bascom, Lisa Blackburn, Richard Binderup, Regina Croucher, Mike Guernsey, Kayreen Handley, Kevin Manson, Carlos Martinez, Mahesh Narayanasami, Kathy Nguyen, Joan Rood, Trey Seel, Angie Storm, James Weaver, David Yates, Soo Yeon Lee.

KPMG LLP is the U.S. firm of the KPMG global organization of independent professional services firms providing Audit, Tax and Advisory services. The KPMG global organization operates in 143 countries and territories and has more than 265,000 partners and employees working in member firms around the world. Each KPMG firm is a legally distinct and separate entity and describes itself as such. For more detail about our structure, please visit home.kpmg/governance.

kpmg.com/socialmedia



The FASB *Accounting Standards Codification*® material is copyrighted by the Financial Accounting Foundation, 801 Main Avenue, Norwalk, CT 06856.

© 2023 KPMG LLP, a Delaware limited liability partnership and a member firm of the KPMG global organization of independent member firms affiliated with KPMG International Limited, a private English company limited by guarantee. All rights reserved. The KPMG name and logo are trademarks used under license by the independent member firms of the KPMG global organization.

The information contained herein is of a general nature and is not intended to address the circumstances of any particular individual or entity. Although we endeavor to provide accurate and timely information, there can be no guarantee that such information is accurate as of the date it is received or that it will continue to be accurate in the future. No one should act upon such information without appropriate professional advice after a thorough examination of the particular situation.